



Installation Guide

# Backup Interface for the Single Phase Energy Hub Inverter with Prism Technology

suitable for use as service equipment

North America

Version 1.1

# Disclaimers

## Important Notice

Copyright © SolarEdge Inc. All rights reserved.

No part of this document may be reproduced, stored in a retrieval system or transmitted, in any form or by any means, electronic, mechanical, photographic, magnetic or otherwise, without the prior written permission of SolarEdge Inc.

The material furnished in this document is believed to be accurate and reliable.

However, SolarEdge assumes no responsibility for the use of this material. SolarEdge reserves the right to make changes to the material at any time and without notice. You may refer to the SolarEdge web site (<https://www.solaredge.com/us/>) for the most updated version.

All company and brand products and service names are trademarks or registered trademarks of their respective holders.

Patent marking notice: see <https://www.solaredge.com/us/patent>

The general terms and conditions of delivery of SolarEdge shall apply.

The content of these documents is continually reviewed and amended, where necessary. However, discrepancies cannot be excluded. No guarantee is made for the completeness of these documents.

The images contained in this document are for illustrative purposes only and may vary depending on product models.

## FCC Compliance

This equipment has been tested and found to comply with the limits for a Class B digital device, pursuant to part 15 of the FCC Rules.

These limits are designed to provide reasonable protection against harmful interference in a residential installation. This equipment generates, uses and can radiate radio frequency energy and, if not installed and used in accordance with the instructions, may cause harmful interference to radio communications. However, there is no guarantee that interference will not occur in a particular installation. If this equipment does cause harmful interference to radio or television reception, which can be determined by turning the equipment off and on, you are encouraged to try to correct the interference by one or more of the following measures:

- Reorient or relocate the receiving antenna.
- Increase the separation between the equipment and the receiver.
- Connect the equipment into an outlet on a circuit different from that to which the receiver is connected.
- Consult the dealer or an experienced radio/TV technician for help.

Changes or modifications not expressly approved by the party responsible for compliance may void the user's authority to operate the equipment.

## Contents

---

Disclaimers .....	1
Important Notice .....	1
FCC Compliance .....	2
Revision History .....	4
<b>HANDLING AND SAFETY INSTRUCTIONS</b> .....	<b>5</b>
Safety Symbols Information .....	5
<b>Chapter 1: Overview</b> .....	<b>6</b>
StorEdge Solution Components .....	6
Installation Equipment List .....	7
<b>Chapter 2: Installing and Connecting the Backup Interface</b> .....	<b>9</b>
Package Contents .....	9
Mounting the Backup Interface .....	9
Installing the Conduit Holder .....	10
Backup Interface Interfaces .....	13
Connecting the Backup Interface to the Grid and AC Loads Panel .....	14
Connecting the Backup Interface to the Inverter .....	16
Connecting the Backup Interface to an External Rapid Shutdown Switch .....	18
<b>Chapter 3: System Configuration</b> .....	<b>20</b>
Troubleshooting .....	21
Appendix A: Manually Switching the System to the Grid-connected Mode .....	22
Appendix B: Connecting External CTs .....	23
Appendix C: System Performance LED Indication .....	25
Appendix D: StorEdge Backup Interface Technical Specifications .....	26
Support Contact Information .....	28

# Revision History

## Version 1.1 (September 2020)

- Added the requirement for a soft start device installation, in case of high-consumption loads in *Connecting the Backup Interface to the Grid and AC Loads Panel* on page 14.
- Updated the torque values.
- Updated the configuration flow in *System Configuration* on page 20.
- Changed the recommended communication cable type to CAT6.

## Version 1.0 (April 2020)

- First version of this guide

# HANDLING AND SAFETY INSTRUCTIONS

During installation, testing and inspection, adherence to all the handling and safety instructions is mandatory. **Failure to do so may result in injury or loss of life and damage to the equipment.**

## Safety Symbols Information

The following safety symbols are used in this document. Familiarize yourself with the symbols and their meaning before installing or operating the system.

### WARNING!

Denotes a hazard. It calls attention to a procedure that, if not correctly performed or adhered to, could result in **injury or loss of life**. Do not proceed beyond a warning note until the indicated conditions are fully understood and met.



### AVERTISSEMENT!

*Dénote un risque: il attire l'attention sur une opération qui, si elle n'est pas faite ou suivie correctement, pourrait causer des blessures ou un danger de mort. Ne pas dépasser une telle note avant que les conditions requises soient totalement comprises et accomplies.*

### CAUTION!

Denotes a hazard. It calls attention to a procedure that, if not correctly performed or adhered to, could result in **damage or destruction of the product**. Do not proceed beyond a caution sign until the indicated conditions are fully understood and met.



### ATTENTION!

*Dénote un risque: il attire l'attention sur une opération qui, si elle n'est pas faite ou suivie correctement, pourrait causer un dommage ou destruction de l'équipement. Ne pas dépasser une telle note avant que les conditions requises soient totalement comprises et accomplies.*



### NOTE

Denotes additional information about the current subject.



### IMPORTANT SAFETY FEATURE

Denotes information about safety issues.

# Chapter 1: Overview

The Backup Interface is a key component in SolarEdge's Flexible Backup solution, controlling disconnection of house loads from the grid in the event of grid interruption. Homeowners are automatically provided with backup power in the event of grid interruption to whole home or selected loads. Solar energy can be stored in a battery for Smart Energy Management applications such as export control, offering demand response and peak shaving, and performing time of use shifting for reduced electric bills.

## StorEdge Solution Components

- **Energy Hub inverter** - manages battery and system energy, in addition to its traditional functionality as a DC-optimized PV inverter.  
The **StorEdge Connection Unit**, located at the bottom of the inverter, allows simple installation and connectivity to other system components and includes a DC Safety Switch.
- **One or two batteries (optional)** - DC-coupled batteries designed to work with the SolarEdge system. The batteries can be connected to the system optionally and require the Backup Interface to be installed.
- **Backup Interface** - controls disconnection of house loads from the grid and integrates the following components to enable grid-tied solar backup and Smart Energy Management. The Backup Interface must be installed to allow the operation of batteries.
  - **Energy Meter** - is used by the inverter for export, import, production and consumption readings, and for Smart Energy Management applications, such as: export limitation, time-of-use profile programming and maximizing self-consumption.
  - **Auto-transformer** - handles the phase load balancing.
  - **200A microgrid interconnection device** - disconnects the house loads from the grid in case of a power outage.
  - **Generator hardware support** - supports connection for up to 15kW alternative power supply. Generator connection requires supporting inverter firmware.

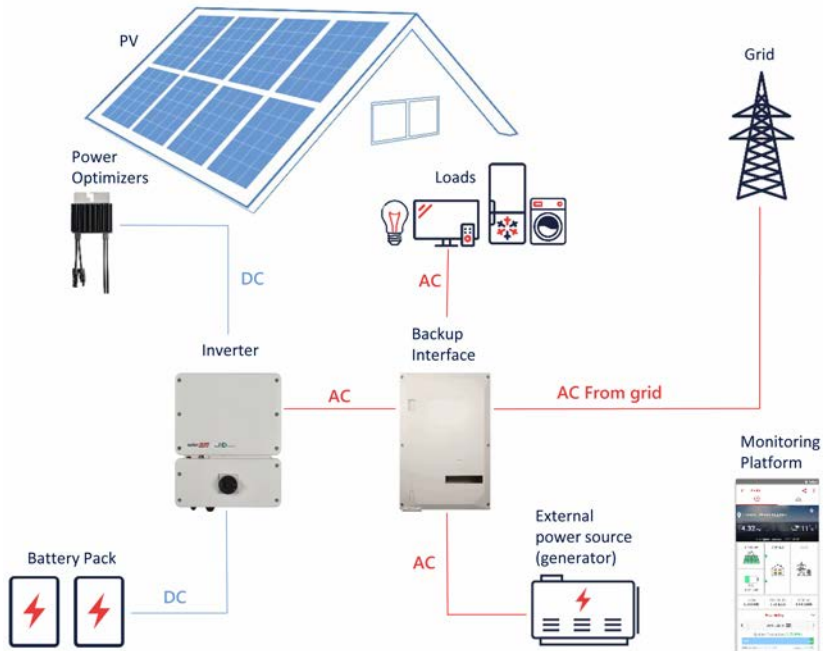

Figure 1: Energy Hub system components

## NOTE

- PV modules connected to power optimizers are not mandatory for charge/discharge profile programming.

## Installation Equipment List

Standard tools can be used during the installation of the SolarEdge system. The following is a recommendation of the equipment needed for installation:

- Allen screwdriver for 5mm screw type for the inverter enclosure screws
- Standard flat-head screwdrivers set
- Non-contact voltage detector
- Cordless drill (with a torque clutch) or screwdriver and bits suitable for the surface on which the inverter and optimizers will be installed and for opening the StorEdge Connection Unit drill guides. Use of an impact driver is *not* allowed.
- Mounting hardware (stainless bolts, nuts, and washers) for attaching:



- the mounting brackets to the mounting surface
- the power optimizer to the racking
- Wire cutters (for wires of up to 4/0 AWG)
- Wire strippers (for wires of up to 4/0 AWG)
- Voltmeter

For installing the communication options, you may also need the following:

- For Ethernet:
  - CAT6 twisted pair Ethernet cable with RJ45 connector
  - If using a CAT6 cable spool: RJ45 plug and RJ45 crimper
- For RS485:
  - Four- or six-wire shielded twisted pair cable
  - Watchmaker precision screwdriver set

## Chapter 2: Installing and Connecting the Backup Interface

This section explains how to install the Backup Interface and connect it to the inverter, AC loads panel and grid.

### Package Contents

- Backup Interface
- Mounting bracket
- Conduit holder
- Accessories bag that contains:
  - Bonding jumper for connecting the neutral and grounding bar
  - Two mounting bracket screws
  - One conduit holder screw
- Allen key (affixed to the bottom of the Backup Interface)
- Installation guide

### Mounting the Backup Interface

#### Before you begin

The conduit entries are closed with drill guides. Drill the conduit entries open before mounting the Backup Interface.

#### CAUTION!

HEAVY OBJECT. To avoid muscle strain or back injury, use proper lifting techniques, and if required - a lifting aid.



#### ATTENTION!

*Objet lourd. Pour éviter la fatigue musculaire ou des blessures au dos, utilisez des techniques de levage appropriées et, si nécessaire - un auxiliaire de levage lors du retrait.*

#### NOTE



Make sure the mounting surface or structure can support the weight of the Backup Interface and bracket, and make sure that it spans the width of the bracket.

#### NOTE



If installing the Backup Interface in the line-side of the main service panel, maintain a distance of not more than 25 ft from the main service panel.

**→ To mount the Backup Interface:**

1. Determine the Backup Interface mounting location, on a wall, stud framing or pole. It is recommended to mount the Backup Interface in a location protected from direct sunlight.
2. To allow proper heat dissipation, maintain at least a 4" clearance between the Backup Interface and other objects.
3. Position the mounting bracket against the wall/pole and mark the drilling hole locations.
4. Drill the holes and mount the bracket. Verify that the bracket is firmly attached to the mounting surface.
5. Hang the Backup Interface on the bracket.

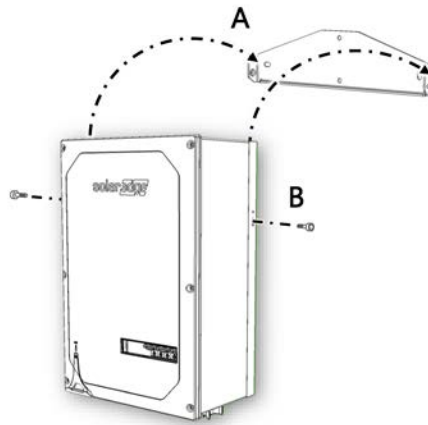

Figure 2: Mounting the Backup Interface

6. Insert the two supplied screws through the outer heat sink fin on both sides of the Backup Interface and into the bracket. Tighten the screws with a torque of 35 in\*lbs / 4.0 N\*m.

## Installing the Conduit Holder

To ensure the Grid and AC Loads conduits are firmly secured in their place, a conduit holder is supplied with the Backup Interface.

Install the conduit holder only after mounting the Backup Interface.

→ To install the conduit holder:

1. Insert the conduit holder in the space between the fins of the heat sink and the mounting surface.
2. Slide the conduit holder first to the left and then down to hang it on the short fin and the bolt affixed to the outer left fin.

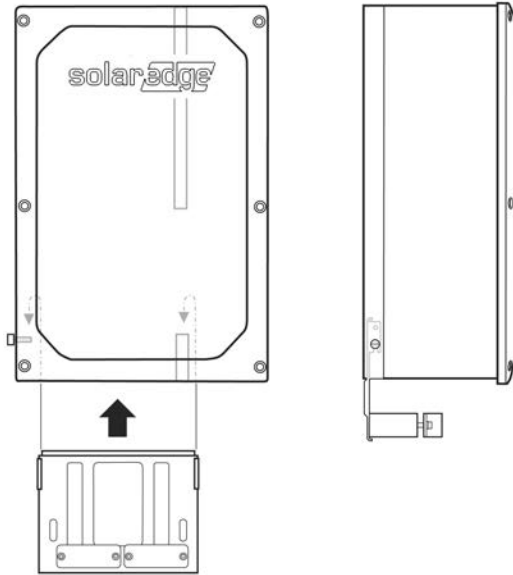

Figure 3: Installing the Backup Interface

3. Mark spots for drilling on the mounting surface.

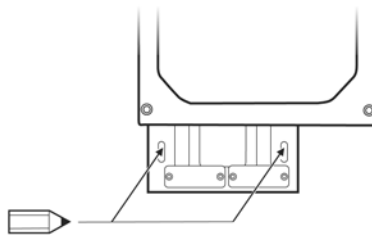

Figure 4: Marking drilling spots

4. Remove the conduit holder.

5. Drill two holes where marked.

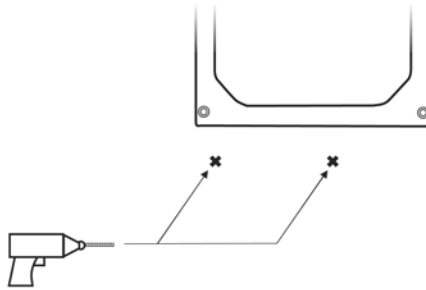

Figure 5: Drilling holes

6. Install the conduit holder.
7. Tighten the conduit holder to the mounting surface with two screws.

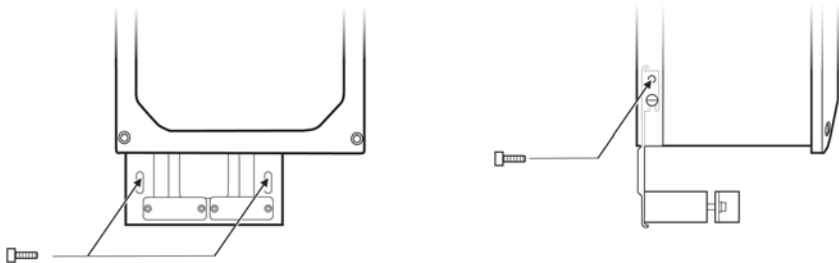

Figure 6: Securing the conduit holder with screws

8. Tighten the conduit holder to the outer left fin with the supplied screw. Tighten the screw with a torque of 41.6 in\*lbs / 4 N\*m.

## Backup Interface Interfaces

The following figure shows the Backup Interface interfaces for operating and connecting to other system components.

Install cable conduits, as required by local regulations.

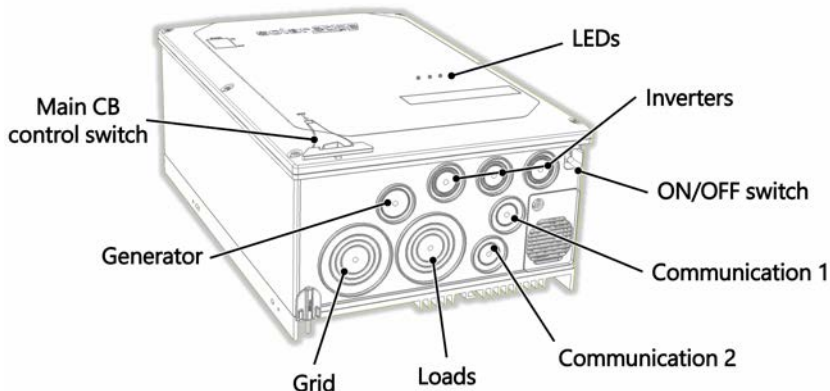

Figure 7: Backup Interface Interfaces

- **Inverter AC inputs** - AC cables from up to three inverters.
- **Generator AC input** - an AC cable from one external generator.
- **Grid AC input** - an AC cable from the grid.
- **Loads AC output** - an AC cable to the loads panel.
- **Communication input** - Communication cables from inverters and external rapid shutdown switch.
- **ON/OFF switch** - When ON, enables automatic transition to backup mode. When OFF, enables manual control of the Backup Interface.
- **LEDs** - Three LEDs (AC, Comm, Fault) indicate system performance. For more information, see *System Performance LED Indication* on page 25.
- **Main circuit breaker control switch** - Toggles the main circuit breaker. Pulling the lever down switches off the main circuit breaker.

## Connecting the Backup Interface to the Grid and AC Loads Panel

For connecting the Backup Interface to the grid and loads panel, use the following cable types:

- For the grid - 4-4/0 AWG
- For the loads panel - 4-4/0 AWG

### NOTE



Backing up high-consumption loads, such as whole home air conditioners and well pumps, requires installation of a soft start device (not supplied by SolarEdge) on the AC supply of these loads.

### → To connect to the Grid and Loads panels

1. Release the six Allen screws of the Backup Interface cover and remove the cover.



### NOTE

Do not remove the internal plastic cover (dead front).

2. Install a conduit of the required diameter into the Loads conduit entry. Use the conduit holder to support the conduit.
3. Install a conduit of the required diameter into the Grid conduit entry. Use the conduit holder to support the conduit.
4. Remove the plastic covers from Loads terminals.
5. If required, connect the grounding and neutral bars with the bonding jumper, supplied with the Backup Interface. Tighten the bonding screws with a torque of 41.6 in\*lbs / 4 N\*m.
6. Pass the cable from the AC Loads panel through the Loads conduit.
7. Pass the cable from the grid through the Grid conduit.
8. Connect the neutral and grounding wires to the neutral and grounding terminals. Tighten the terminal screws with a torque of 200 in\*lbs / 22.5 N\*m.

9. Connect Line 1 and Line 2 wires from the AC loads panel to the loads line terminal. Tighten the terminal screws with a torque of 200 in\*lbs / 22.5 N\*m.

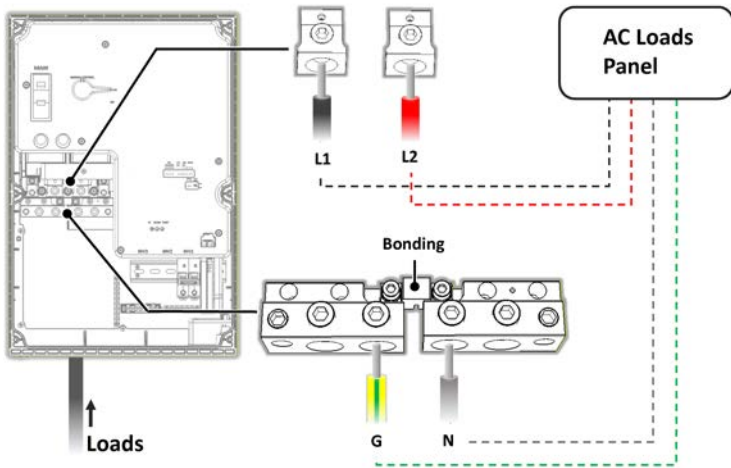

Figure 8: Connection to the AC Loads Panel

10. Connect the Line 1 and Line 2 wires to the grid's line terminal. Tighten the terminal screws with a torque of 200 in\*lbs / 22.5 N\*m.

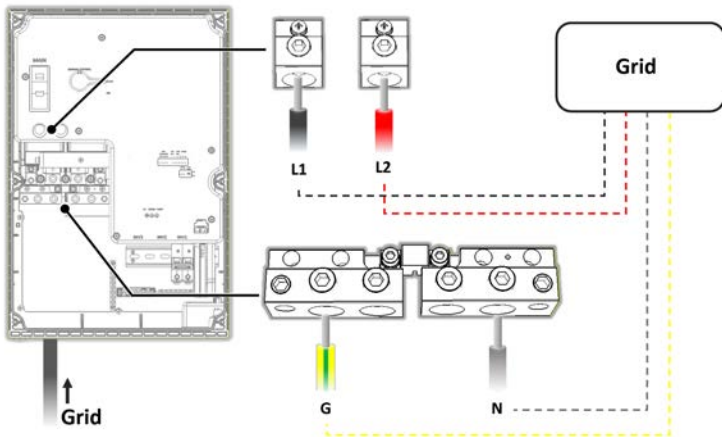

Figure 9: Connection to the Grid

11. Reinstall the plastic covers onto the loads terminals.



## Connecting the Backup Interface to the Inverter

When connecting the Backup Interface to the Single phase energy hub inverter with prism technology, use the following cable types:

- **Communication** - 5-wire shielded twisted pair cable, 24 AWG (16-24 AWG), 600V insulated or CAT6
- **12V power** - 16 AWG cable
- **AC power** - 6 AWG (4-20 AWG), 600V insulated cable

**NOTE**



If an auto-transformer is connected to the inverter, make sure to disconnect it before connecting the Backup Interface.

→ **To connect to the communication cable and 12V cable**

1. Install a conduit of the required diameter into the Com 1 conduit entry.
2. Connect the cables **to the Connection Unit of the inverter**:
  - a. Open Communication 1 gland.
  - b. Pass the cables through the gland.
  - c. Remove the 7-pin connector from the slot labeled Backup Interface on the communication board.
  - d. Connect the cable wires to the 7-pin connector, as shown below, and reconnect the connector to the slot:

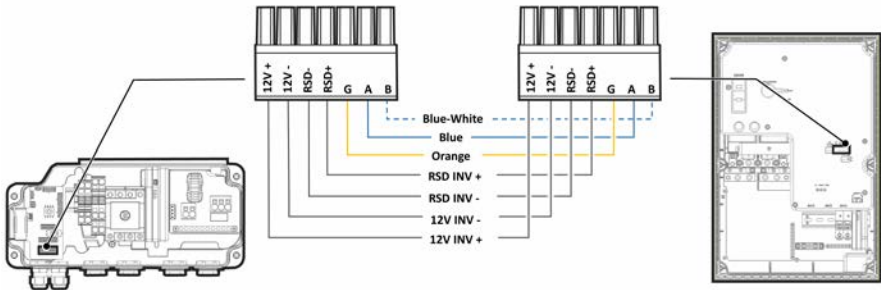

Figure 10: Communication and 12V cables connection between Backup Interface and Inverter

3. Connect the cables to the Backup Interface:
  - a. Pass the cables through the Com 1 conduit.
  - b. Remove the 7-pin connector from the Backup Interface's communication slot.
  - c. Connect the communication cable to the 7-pin connector, as shown above. If there is a short circuit jumper between the RSD terminals of the inverter, remove it before connecting the RSD terminals to the Backup Interface.
  - d. Reconnect the 7-pin connector to the communication slot.
  - e. Move up (ON) the communication DIP switch.

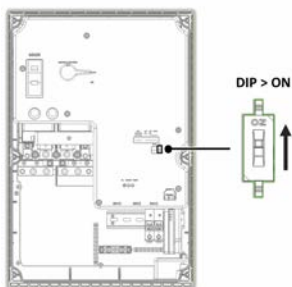

Figure 11: Communication DIP switch setup

→ To connect to the AC cable

1. Connect one end of the AC cable to the AC terminal block in the inverter's Connection Unit, as explained in the Single phase energy hub inverter with prism technology Installation Guide.
2. Install a conduit of the required diameter into the Backup Interface's Inv1 conduit entry.

3. Pass the other end of the AC cable through the Inv1 conduit.

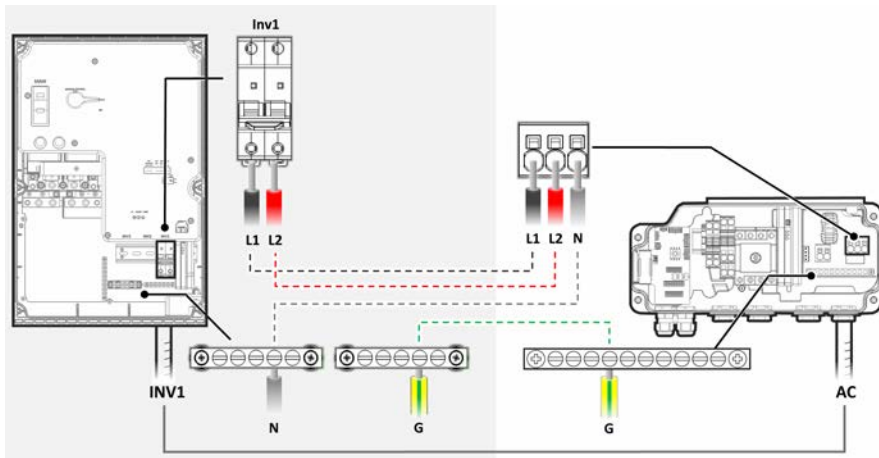

Figure 12: AC connection between the Backup Interface and Inverter

4. Connect the L1 and L2 wires of the AC cable to the Inv1 terminal block, as shown above. Apply a torque of 17.7 in\*lbs / 2 N\*m.
5. Connect the Neutral wire to the Neutral bar.
6. Connect the Grounding wire to the Grounding bar.

## Connecting the Backup Interface to an External Rapid Shutdown Switch

In accordance with regulation requirements, an external shutdown switch must be installed. The switch (not supplied by SolarEdge) shuts down the Backup Interface in case of emergency.

→ To connect to an External Rapid Shutdown Switch

1. Pass the cable from the switch through the Com 2 conduit.

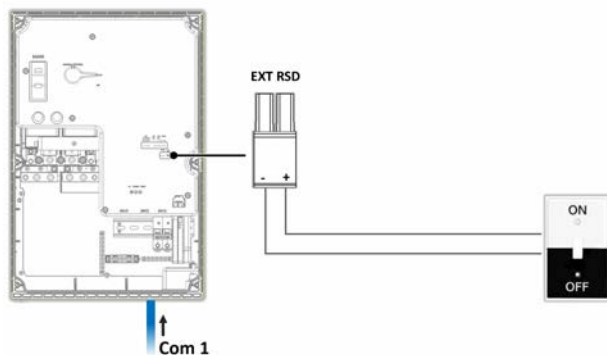

Figure 13: External rapid shutdown switch connection

2. Remove the 2-pin connector labeled EXT RSD.
3. Remove the short circuit jumper from the 2-pin connector.
4. Connect the cable to the 2-pin connector, as shown above.
5. Insert the 2-pin connector back into the EXT RSD port.
6. Reinstall the Backup Interface cover and tighten it with the screws. Apply a torque of 36.6 in\*lbs / 3 N\*m.

## Chapter 3: System Configuration

This chapter explains how to configure your Backup Interface using the SetApp mobile application.

Before you begin, make sure the inverter firmware version is 4.8xx or higher. For information on updating your inverter firmware, refer to the *Inverter Installation Guide*.

→ To enable Backup Configuration:

- Open SetApp and select **Commissioning > Power Control > Energy Manager > Backup Configuration > Backup > Enable**.

After the Backup Configuration is enabled, the Backup Interface is automatically configured.

# Troubleshooting

Error Code	Error Message	Troubleshooting
26x4	Backup Interface state inconsistent	Manually switch the Backup Interface to on-grid (see <i>Manually Switching the System to the Grid-connected Mode</i> on page 22).
26x5	Backup Interface state inconsistent	Manually switch the Backup Interface to on-grid (see <i>Manually Switching the System to the Grid-connected Mode</i> on page 22).
26x6	Backup Interface state inconsistent	Manually switch the Backup Interface to on-grid (see <i>Manually Switching the System to the Grid-connected Mode</i> on page 22).
26x7	Backup Interface thresholds error	Verify correct country configuration.
26xF	Inverter doesn't lower AC voltage	Turn off and then back on the inverter AC and DC switch.
26x11	Backup Interface low temperature	Make sure the ambient temperature is higher than -40 °F (-40 °C).
26x12	Backup Interface high temperature	Make sure ambient temperature is lower than 122 °F (50 °C).
26x14	Phase imbalance too high	Balance the loads on different phases.
3xBD	Backup Interface comm error	Verify that communication between the Backup Interface and inverter over RS485 is set up correctly (see <i>Connecting the Backup Interface to the Inverter</i> on page 16).

## Appendix A: Manually Switching the System to the Grid-connected Mode

In case of a Backup Interface failure or when necessary, you can reconnect the system to AC power from the grid.



### NOTE

When the system is manually switched to the grid-connected mode, no backup of the loads is possible.

→ To switch to the grid-connected mode:

1. Switch the ON/OFF switch of the Backup Interface to OFF.
2. Switch the inverter ON/OFF/P switch to OFF.
3. Release the six Allen screws and remove the Backup Interface cover. You can use the Allen key found at the bottom left side of the Backup Interface.
4. Make sure the Manual Control switch is in the OFF position.

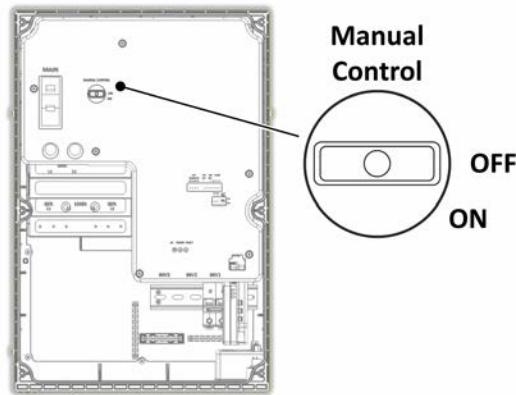

Figure 14: Manual Control switch

5. Reinstall the Backup Interface cover and tighten it with the screws. Apply a torque of 36.6 in\*lbs / 3 N\*m.
6. To start production, switch the inverter ON/OFF/P switch to ON.

## Appendix B: Connecting External CTs

If the Backup Interface does not disconnect all house loads in case of an outage, external Export/Import current transformers (CTs) must be connected to the Energy Meter inside the Backup Interface.

### Required Equipment

- Two split core or flexible coil CTs (available from SolarEdge). For flexible coil CTs, the power supply must be purchased separately.
- Extension cable - a CAT6 shielded cable

#### → To connect external CTs:

1. Switch the ON/OFF switch of the Backup Interface to OFF.
2. Switch the inverter ON/OFF/P switch to OFF.
3. Attach the CTs to L1 and L2 wires at the service entrance point in the main service panel. The arrow on the CTs must point to the current source.
4. Crimp the twisted wire pair of each CT to a twisted pair of the extension cable.

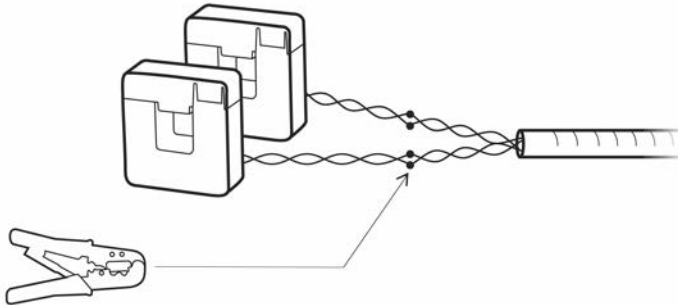

Figure 15: Connecting external CTs to extension cable

5. Release the six Allen screws and remove the Backup Interface cover.
6. Pass the extension cable through the AC conduit into the Backup Interface.
7. Remove the L1 CT and L2 CT connectors from the Energy Meter.



8. Disconnect the internal CT wires from the connectors.

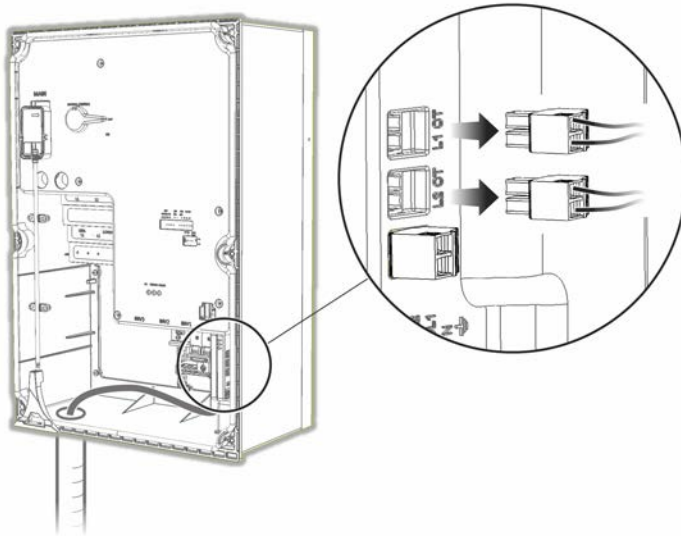

Figure 16: Disconnecting internal CTs

9. Insulate the internal CT wires.
10. Connect the external CTs twisted pairs from the extension cable to the connectors (L1 to L1; L2 to L2).
11. Reinstall the Backup Interface cover and tighten it with the screws. Apply a torque of 36.6 in\*lbs / 3 N\*m.
12. If necessary, switch the inverter ON/OFF/P switch to ON.

## Appendix C: System Performance LED Indication

The three LEDs, visible both on the Backup Interface outer cover and inner cover, indicate the following system states:

LED	AC – Green	Comm – Blue	Fault – Red
On	Backup Interface is in the backup mode	Communication with the inverter is OK	Error
Blinking - turns on and off for the same duration	Backup Interface is in the grid-connected mode	---	---
Off	---	No communication with the inverter	No errors
All LEDs off	No power to Backup Interface		

## Appendix D: StorEdge Backup Interface Technical Specifications

PN	BI-EUSGN-01		Unit
<b>AC FROM GRID</b>			
AC current input	200		A
AC output voltage (nominal)	240		Vac
AC output voltage range	211–264		Vac
AC frequency (nominal)	60		Hz
AC frequency range	59.3–60.5		Hz
Microgrid interconnection device	200		A
Service side AC Main CB rated current	200		A
Service side AC Main CB interrupt current	10k		A
Grid disconnection switchover time	<100		ms
<b>AC TO MAIN DISTRIBUTION PANEL</b>			
Maximum AC current output	200		A
AC L-L output voltage (nominal)	240		Vac
AC L-L output voltage range	211–264		Vac
AC Frequency (nominal)	60		Hz
AC Frequency range	59.3–60.5		Hz
Maximal inverters AC current output in backup operation	78		A
Imbalance compensation in backup operation	5000		W
AC L-N output voltage in Backup (nominal)	120		V
AC L-N output voltage range in backup	105–132		V
AC frequency range in backup	55–65		Hz
<b>INVERTER INPUT</b>			
Number of inverter inputs	3		#
Rated AC power	7,600		W
Maximum continuous output current	32		A
Rated AC power in backup operation	6,100		W
Maximum continuous output current in backup operation	26		A
Peak AC Power (<10 sec) in backup operation	7,000		W
Peak AC Current (<10sec) in backup operation	30		A
Inverter input AC CB	40		A

Upgradability	Up to 3 X 40A CB <sup>(1)</sup>	
<b>GENERATOR</b>		
Maximum rated AC power	15,000	W
Maximum continuous input current	63	Adc
Dry contact switch voltage rating	250/30	Vac/Vdc
Dry contact switch current rating	5	A
2-wire Start Switch	Yes	
<b>ADDITIONAL FEATURES</b>		
Number of communication inputs	2	
Communication	RS485	
Energy Meter (for Import/Export)	1% accuracy	
Manual control over microgrid interconnection device	Yes	
<b>STANDARD COMPLIANCE</b>		
Safety	UL1741, CSA 22.2 NO. 107, UL869A	
Emission	FCC part15 class B	
<b>INSTALLATION SPECIFICATIONS</b>		
Supported inverters	StorEdge Inverter	
AC from grid conduit size / AWG range	2" conduits / #0 - 4/0	
AC inverter conduit size / AWG range	1" conduit / 14 - 4 AWG	
AC generator input conduit size / AWG range	1" conduit / 8 - 3 AWG	
Communication conduit size / AWG range	3/4" / 24 - 10 AWG	
Weight	73 / 33	lb / Kg
Cooling	Fan (user replaceable)	
Noise	< 50	dBA
Operating temperature range	-40 to +122 / -40 to +50	°F / °C
Protection rating	NEMA 3R, IP44	
Dimensions (HxWxD)	20.59 x 13.88 x 8.62 / 523.5 x 352.5 x 219	in / mm

<sup>(1)</sup>Each 40A CB supports an 7600W inverter; CB upgrade kit is available with the following part numbers: for 40A CB CB-UPG-40-01

## Support Contact Information

If you have technical problems concerning SolarEdge products, please contact us:



<https://www.solaredge.com/us/service/support>

Before contact, make sure to have the following information at hand:

- Model and serial number of the product in question.
- The error indicated on the product SetApp mobile application or on the monitoring platform or by the LEDs, if there is such an indication.
- System configuration information, including the type and number of modules connected and the number and length of strings.
- The communication method to the SolarEdge server, if the site is connected.
- The product's software version as it appears in the status screen.

**solar**edge