



Please read these instructions carefully before installing

This will ensure an easy start and a great first customer experience with TS4 installation

INTERACTIVE

INSTALLATION AND SAFETY MANUAL
FOR TS4: SMART MODULES AND RETROFIT

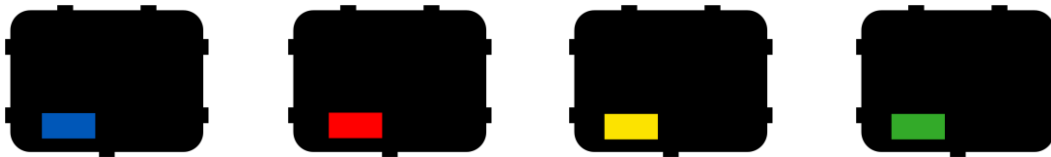

CLICK TO CONTINUE



It is highly recommended to view in full screen mode



THE INTERACTIVE MANUAL

This manual contains action buttons, designated to help you navigate around and find the most relevant information for your installation



Next

Goes to the next page



Back

Goes to the previous page



Home

Goes to the product selection page

ON THIS SIDE:

You'll see clarification, additional information, and links for external pages

CLICK TO CONTINUE



READ THIS FIRST

IMPORTANT SAFETY INSTRUCTIONS

SAVE THESE INSTRUCTIONS

LETHAL VOLTAGE MAY BE PRESENT IN ANY PV INSTALLATION

- This manual contains important instructions for installation and maintenance of the Tigo Energy® product models TS4-L, TS4-O, TS4-S, TS4-M, TS4-R-M, TS4-R-S, TS4-R-O, ES-GTWY-020, Cloud Connect, Cloud Connect Advanced and related Tigo Energy software applications.
- Risk of electric shock, do not remove cover, disassemble, or repair, no user serviceable parts inside. Refer servicing to qualified service personnel.
- Before installing or using the Tigo Energy® System, please read all instructions and warning markings on the Tigo Energy products, appropriate sections of your inverter manual, photovoltaic (PV) module installation manual, and other available safety guides.
- Failure to adhere to these instructions may result in injury or death, damage to the system or voiding the factory warranty.
- To reduce risk of fire and shock hazard, install this device with strict adherence to National Electric Code (NEC) ANSI/NFPA 70 and/or local electrical codes. When the photovoltaic array is exposed to light, it supplies a DC voltage to the Tigo Energy® Module Maximizer™. The Module Maximizers and Smart Modules start in the “ON” state and their output voltage may be as high as the PV module open circuit voltage (Voc) when connected to the module. The installer should use the same caution when handling electrical cables from a PV module with or without the Tigo Energy Module Maximizer attached.
- Installation must be performed by trained professionals only. Tigo Energy does not assume liability for loss or damage resulting from improper handling, installation, or misuse of products.
- Remove all metallic jewelry prior to installing the Tigo Energy Module Maximizers or Smart Modules to reduce the risk of contacting live circuitry. Do not attempt to install in inclement weather.
- Do not operate the Tigo Energy Module Maximizers or Smart Modules if they have been physically damaged. Check existing cables and connectors, ensuring they are in good condition and appropriate in rating. Do not operate Tigo Energy Module Maximizers or Smart Modules with damaged or substandard wiring or connectors. Tigo Energy Module Maximizers must be mounted on the high end of the PV module back-sheet or racking system, and in any case above ground.
- Do not connect or disconnect under load. Turning off the Inverter and/or the Tigo Energy products may not reduce this risk. Internal capacitors within the inverter can remain charged for several minutes after disconnecting all power sources. Verify capacitors have discharged by measuring voltage across inverter terminals prior to disconnecting wiring if service is required.
- Service Personnel: Check the voltage of the array after activating the Tigo Energy® PV-Safe™ function on the MMU prior to performing service.
- Always assume Module Maximizers and Smart Modules are in “ON” state, or may turn on when restarting.



TS4 PLATFORM: BASE

This manual covers the installation steps for the Tigo TS4 family of products, both integrated and add-on versions.



Module integrated TS4



Add-on TS4-R

GUIDE:



Long Strings



Optimization



Rapid Shutdown



Monitoring

WHERE TO BUY:

[CLICK HERE](#)



TS4 PLATFORM: COVER SELECTION

The TS4 covers contain your [module level electronics](#):

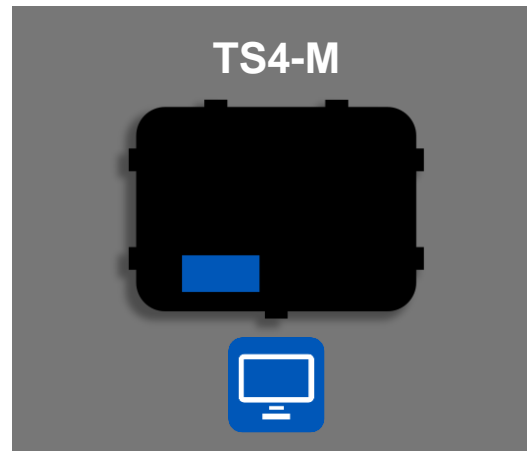
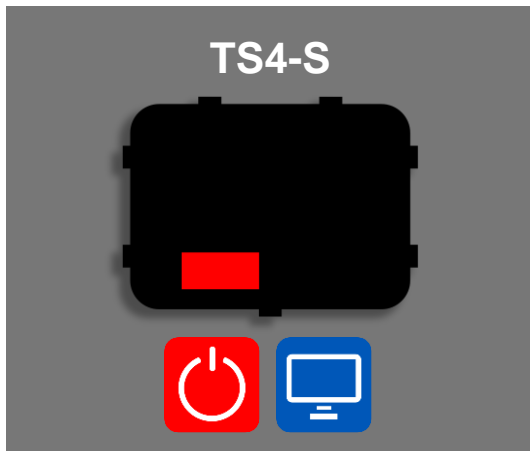

*TS4-L is available only for the module-integrated TS4

GUIDE:



Long Strings



Optimization



Rapid Shutdown



Monitoring

WHERE TO BUY:

[CLICK HERE](#)



COMMUNICATION

The Cloud Connect is your [data logger](#) and [safety control unit](#).

The Gateway is an [antenna](#) that communicates with your smart modules or add-on devices.

It is always recommended to install communication accessories, to utilize the full potential of your TS4, however it is only mandatory in order to enable monitoring and safety features, such as Rapid Shutdown.

Select your model of [Cloud Connect](#):



ORDERING INFORMATION:

Cloud Connect Kit comes with:

1 Gateway

1 Power supply: 2 different options:

1. Wall Outlet

2. DIN Rail

Additional Gateways available separately

WHERE TO BUY:

[CLICK HERE](#)

REMINDER:

When using TS4-O and TS4 -L, Cloud Connect is only required where rapid shutdown and/or monitoring capabilities are needed



TABLE OF CONTENTS

1. System Overview & Product Description

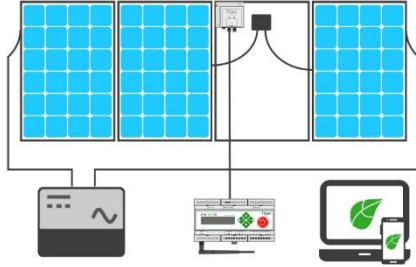

2. Installing Gateways



3. Installing Cloud Connect

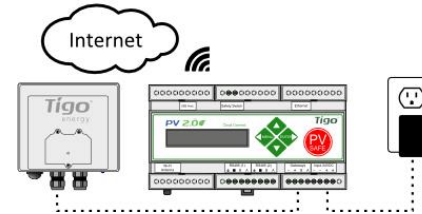

4. Installing TS4-R

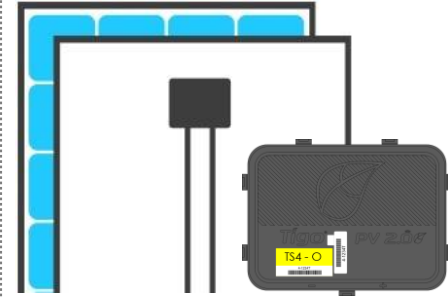

5. Online Configuration

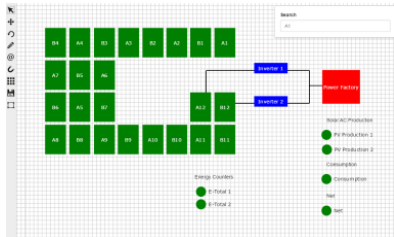

6. Commissioning

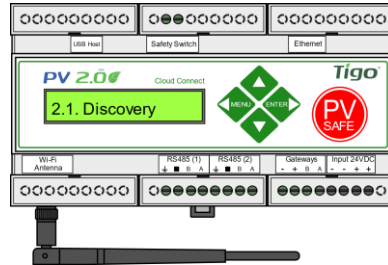

7. Rapid Shutdown

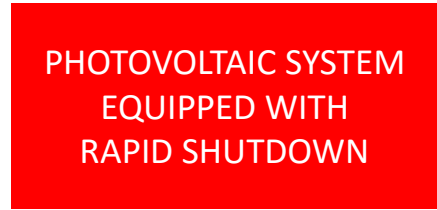

8. Connecting Modbus Accessories

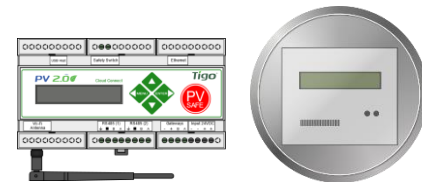

1. SYSTEM OVERVIEW: TS4-B (TS4 BASED MODULES)

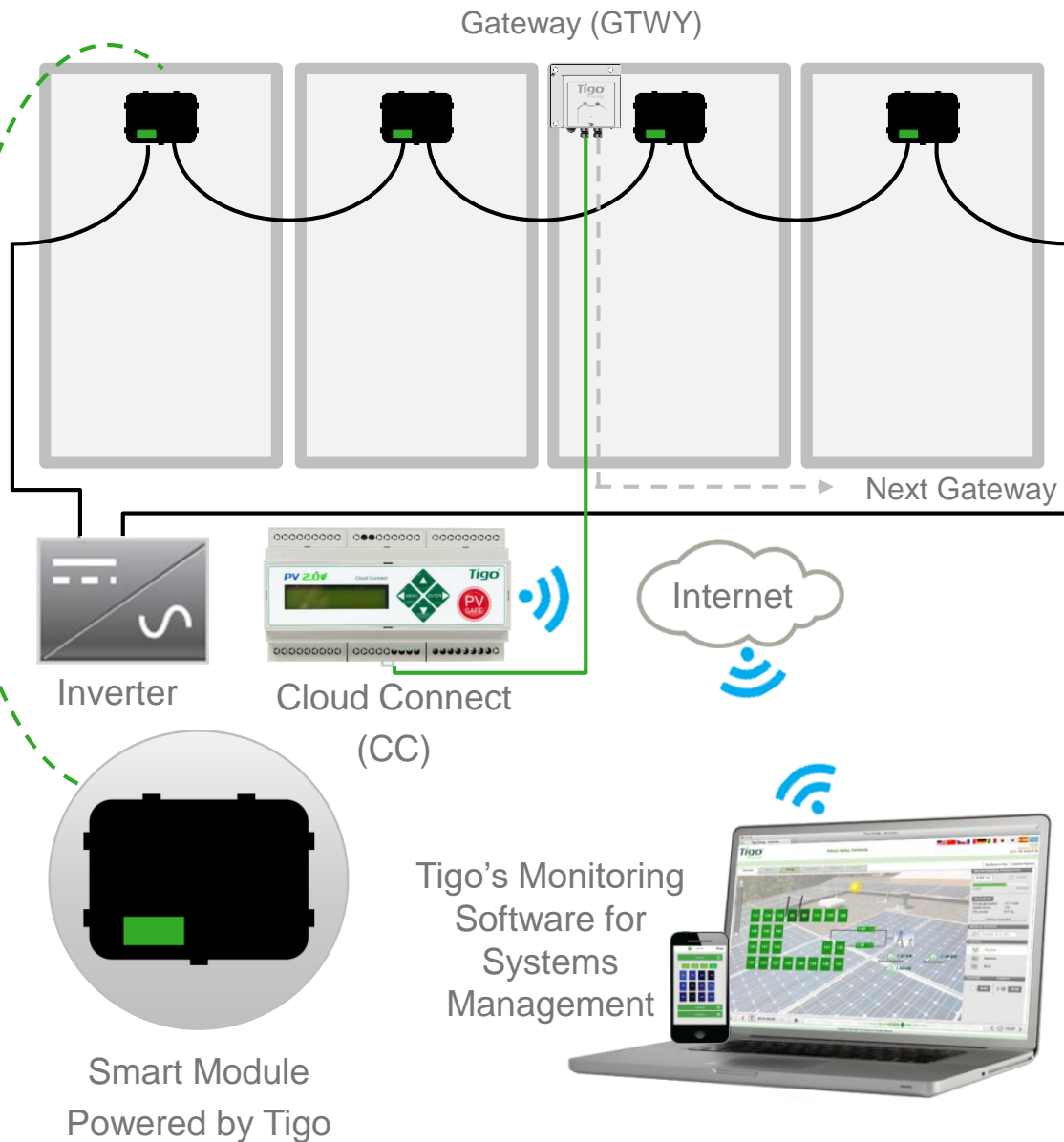

DESIGN RULES:

1 CLOUD CONNECT:

- Up to 7 GTWYs and 360 PV modules
- All Smart Modules in the same string must be assigned to the same CC

1 GTWY:

- Up to 120 PV modules
- Modules must be within 10m-15m (33-50 ft.) from the GW, depending on roof topology and material

For further information [CLICK HERE](#)

CC AND GTWY CALCULATOR:

For the number of CCs and GTWYs required for your project [CLICK HERE](#)



1. SYSTEM OVERVIEW: TS4-R



DESIGN RULES:

1 CLOUD CONNECT:

- Up to 7 GTWYs and 360 PV modules
- All Smart Modules in the same string must be assigned to the same CC

1 GTWY:

- Up to 120 PV modules
- Modules must be within 10m-15m (33-50 ft.) from the GW, depending on roof topology and material

For further information [CLICK HERE](#)

CC AND GTWY CALCULATOR:

For the number of CCs and GTWYs required for your project [CLICK HERE](#)



1. SYSTEM OVERVIEW & PRODUCT DESCRIPTION

TS4-M: MONITORING: The TS4-M provides continuous system-wide monitoring for fleets to make customer support and fleet workflow on track



TS4-S: SAFETY: The TS4-S provides the necessary safety and monitoring services required by municipalities



TS4-O: OPTIMIZATION: In addition to safety, monitoring, and PV2.0 synchronization, TS4-O optimizes each PV module when its performance is affected by shade or mismatch



TS4-L: LONG STRINGS: The TS4-L is the complete Smart Module solution. It is ideal for systems requiring fully optimized performance at the module level, monitoring, safety, and longer strings [CLICK HERE](#) to see the TS4-L string sizing info.



MORE INFORMATION:

[Click here](#) to learn more, watch a video and see the TS4 platform datasheet.



2. INSTALLING GATEWAYS (GTWY)

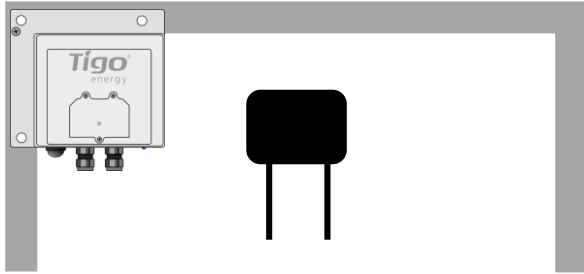

Gateway attaches to module frame using provided bracket

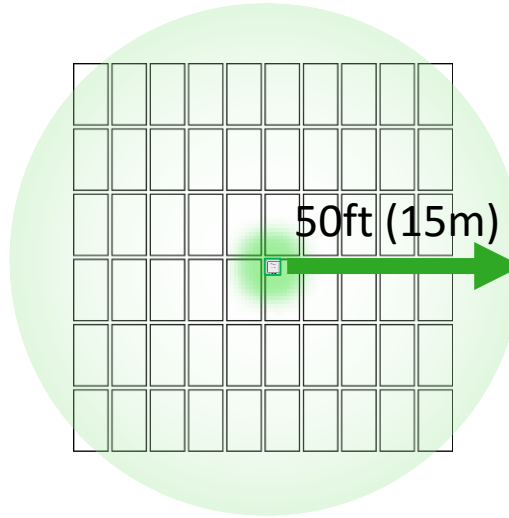

Locate Gateway near center of array or each sub-array

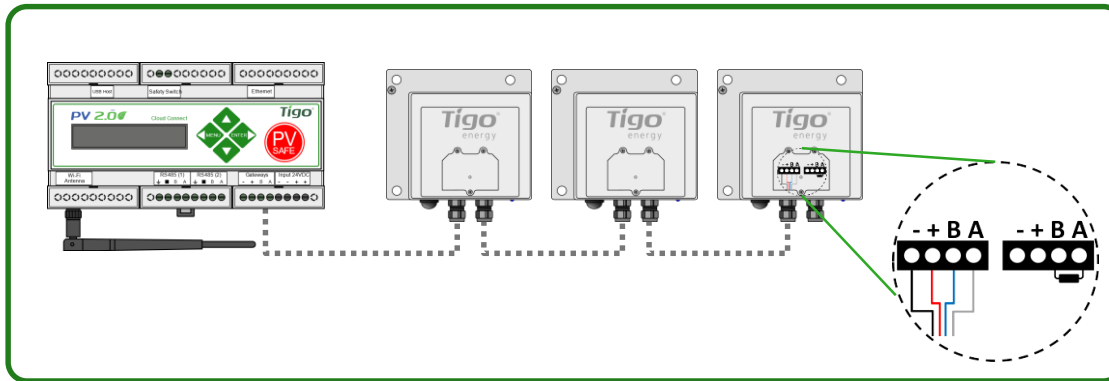

Connect multiple Gateways in series and leave terminating resistor only in final Gateway.

INSTALLATION:

1. Connect all GTWY cables before powering ON Cloud Connect
2. Mount GTWY on back of PV module using provided bracket, or bolt to the racking system
3. Powering ON Cloud Connect and preform GTWY test from the Tigo SMART App

RS-485 communication cable is recommended: 2 x twisted pair, sunlight resistant of direct burial.

MORE INFORMATION

- [Gateway Hardware Guide](#)
- [Gateway Placement Guide](#)
- [Communication Cable Guide](#)

NOTE:

Gateway enclosure can be white or black



3. INSTALLING THE CLOUD CONNECT

OPTIONAL
Connect an External Switch for PV-OFF, [click here](#) for instructions

1
Network
Wired **Ethernet** and **Wi-Fi** connections

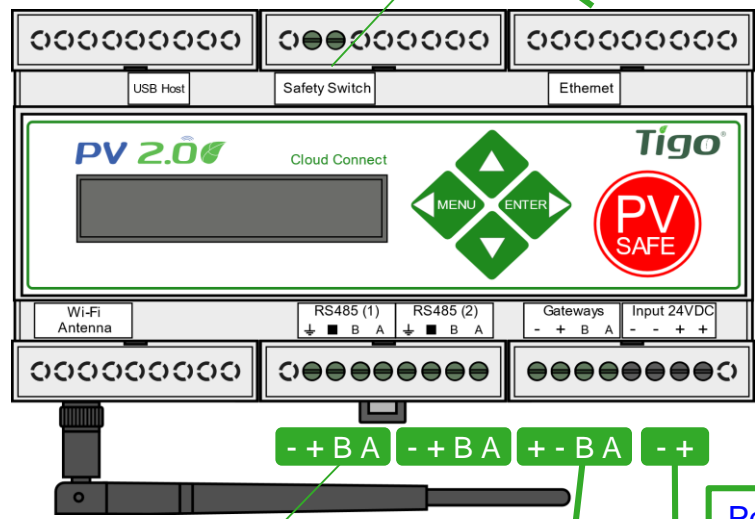

RS485
for 3rd party Modbus devices

3
Power Supply
24Vdc input

Wireless Capabilities
Use Wi-Fi for your Internet connection and for commissioning with a smartphone

2
Gateway
Plug in GTWY(s) cable after all the GTWY(s) are connected in series (next page)

For Rapid Shutdown, install on the same AC panel as the inverter

WHERE TO PLACE:

- On a wall or beam
- Next to the inverter
- **Out of direct sunlight**

3 CONNECTIONS:

1. Internet connection, using one of the options:
 - Ethernet Port
 - Built in Wi-Fi
 - Wi-Fi connection is configured using the Tigo SMART app
2. Gateway
 - Connect using RS485 cable
3. Power supply

*In case CC is mounted in a metal enclosure, extend this antenna out of the box in order to use Wi-Fi as an Internet connection



POWER SUPPLY OPTIONS

Wall Outlet Plug (DC Transformer)		Din Rail	
Tigo Power supply only P/N	983-00070-00	Tigo Power supply only P/N	983-00054-00
Tigo CC Kit P/N	333-00000-10	Tigo CC Kit P/N	333-00000-00
Manufacturer, P/N	Click, CPS024240100*	Manufacturer, P/N	Mean Well, DR-15-24
Input	85-264VAC 47Hz-63Hz	Input	100-240VAC 50Hz/60Hz
Output	24VDC 0.63A	Output	24VDC 1A
Temperature rating	0°C to +45°C	Temperature rating	-20°C to +60°C

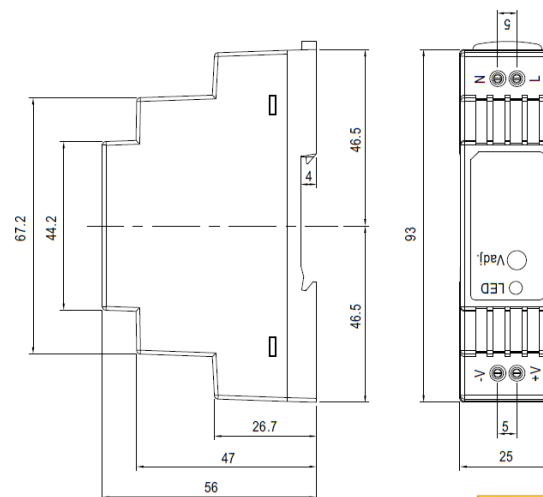
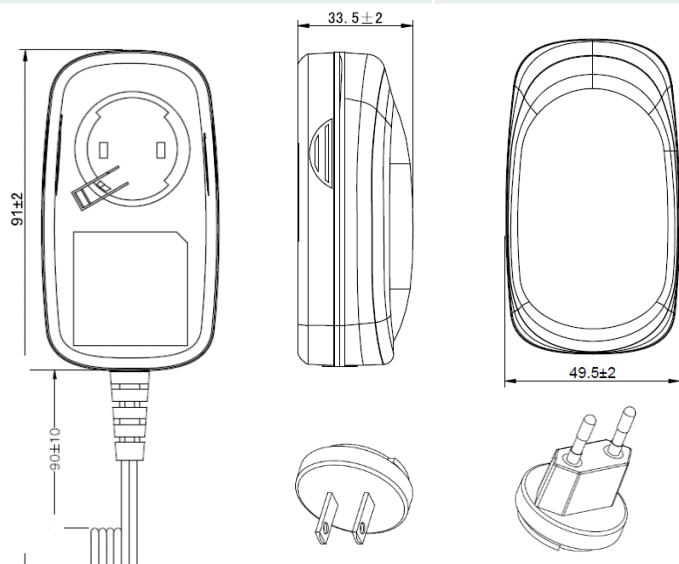

CLOUD CONNECT WIRING REFERENCE

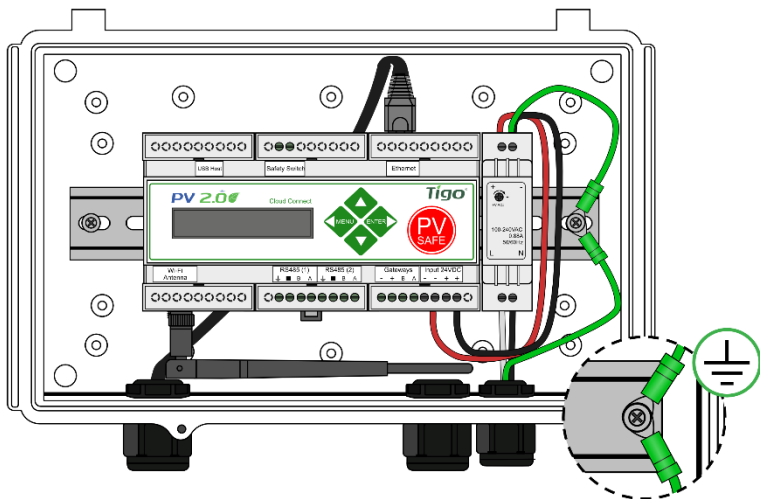

Cloud Connect with DIN rail power supply

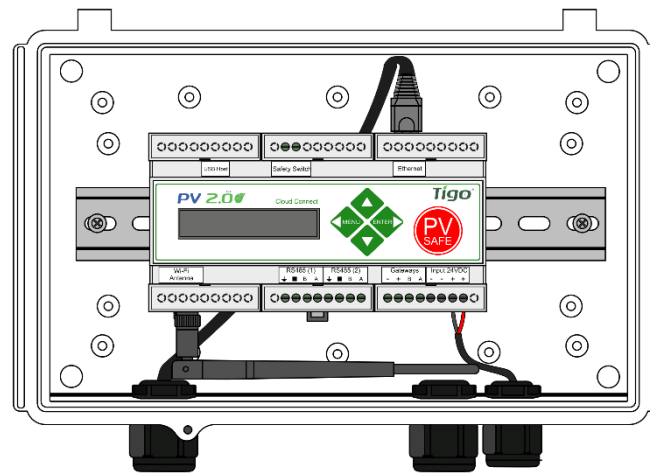

Cloud Connect with DC transformer

- Connect DC leads from power supply to Cloud Connect
- Connect AC and DC ground wires to DIN rail
- Connect AC power input to power supply

- Connect DC leads from power supply to Cloud Connect

[Click here for the Cloud Connect installation quick start guide](#)



MENU OPTIONS FOR THE CLOUD CONNECT

Use the LCD and buttons to navigate the different menu options

1. Status

1. Modules
 1. Signal
 2. Voltage
 3. Power
2. Date / time
3. Unit ID
4. Version
5. Config (Tigo internal use only)

2. Control

1. Discovery
2. Modules ON
3. Push data
4. Restart
5. Gateway test
6. Replace Gateway
7. HW test (Tigo internal use only)

3. Network

1. Display IP
2. Test
3. Configure
4. Set proxy
5. Renew

Blue are used during standard installation process **Green** may be used to get additional information **Orange** should only be used when instructed by technical support **red** are additional control buttons or advanced settings. Detailed explanation of each function can be found [here](#).



4. INSTALLING: TS4-R

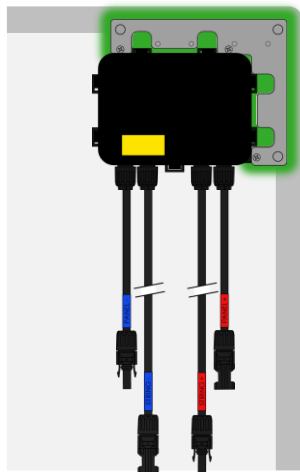

1

Mount the TS4-R on the top right corner of the PV module

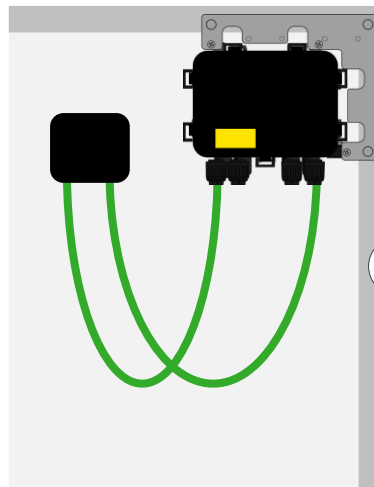

2

Connect the PV cables from the module to the short leads of the TS4-R

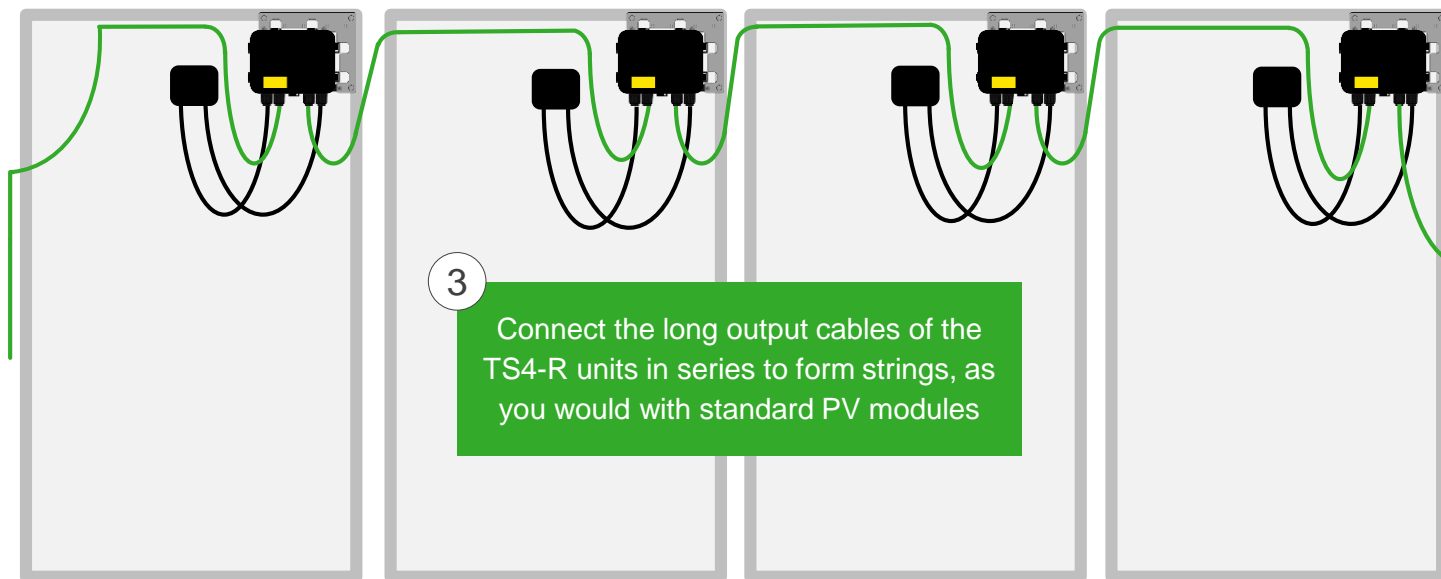

3

Connect the long output cables of the TS4-R units in series to form strings, as you would with standard PV modules



TABLE OF CONTENTS

1. System Overview & Product Description

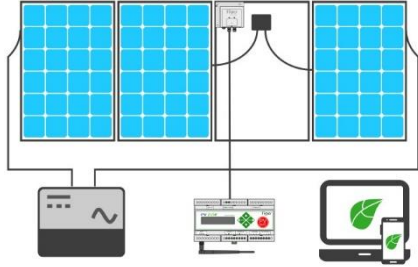

2. Installing Gateways



3. Installing CCA

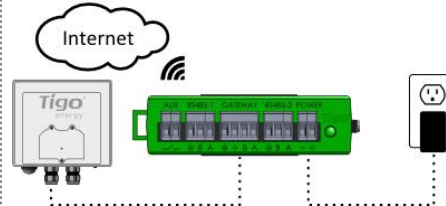

4. Installing TS4-R

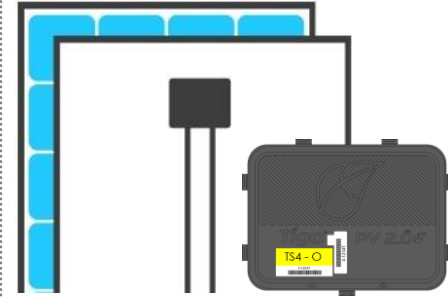

5. Online Configuration

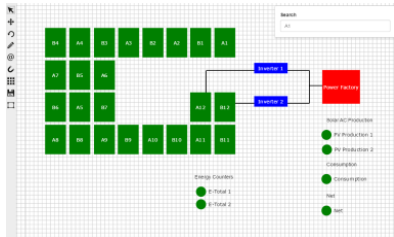

6. Commissioning

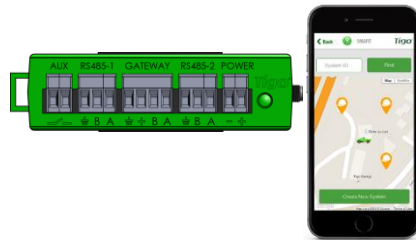

7. Rapid Shutdown

PHOTOVOLTAIC SYSTEM
EQUIPPED WITH
RAPID SHUTDOWN

8. Connecting Modbus Accessories

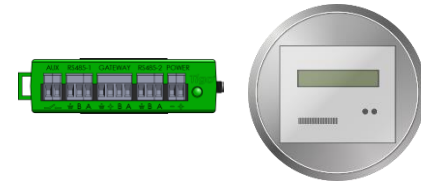

1. SYSTEM OVERVIEW: TS4-B (TS4 BASED MODULES)

Gateway (GTWY)

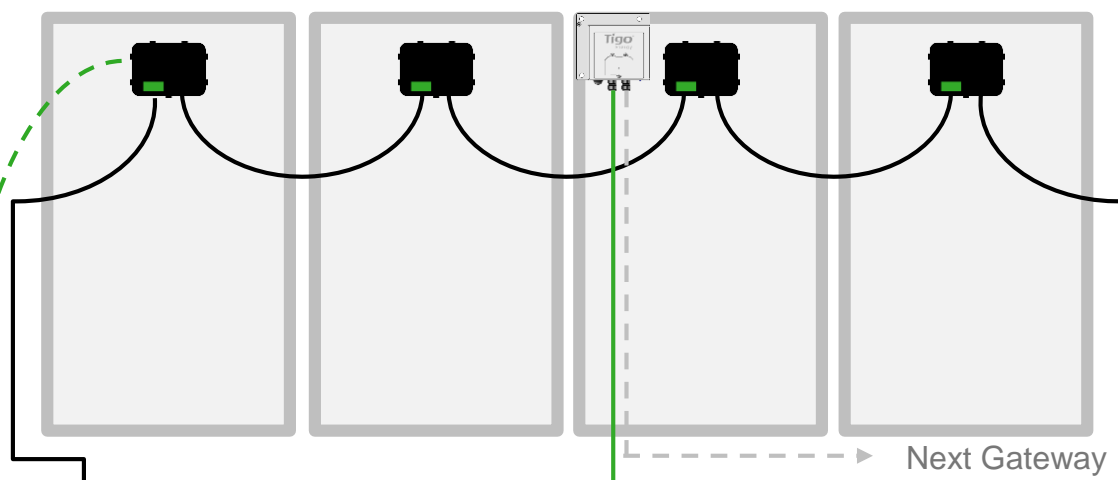

Inverter



Cloud Connect Advanced
(CCA)



Internet

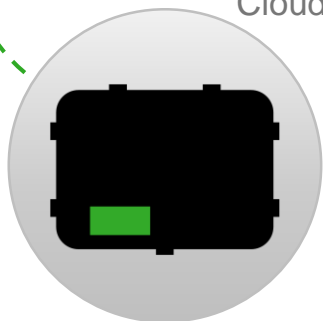

Smart Module
Powered by Tigo

Tigo's Monitoring
Software for
Systems
Management



DESIGN RULES:

1 CLOUD CONNECT ADVANCED:

- Up to 7 GTWYs and 360 PV modules
- All Smart Modules in the same string must be assigned to the same CCA

1 GTWY:

- Up to 120 PV modules
- Modules must be within 10m-15m (33-50 ft.) from the GW, depending on roof topology and material

For further information [CLICK HERE](#)

CCA AND GTWY CALCULATOR:

For the number of CCAs and GTWYs required for your project [CLICK HERE](#)



1. SYSTEM OVERVIEW: TS4-R



DESIGN RULES:

1 CLOUD CONNECT ADVANCED:

- Up to 7 GTWYs and 360 PV modules
- All Smart Modules in the same string must be assigned to the same CCA

1 GTWY:

- Up to 120 PV modules
- Modules must be within 10m-15m (33-50 ft.) from the GW, depending on roof topology and material

For further information [CLICK HERE](#)

CCA AND GTWY CALCULATOR:

For the number of CCAs and GTWYs required for your project [CLICK HERE](#)



1. SYSTEM OVERVIEW & PRODUCT DESCRIPTION

TS4-M: MONITORING: The TS4-M provides continuous system-wide monitoring for fleets to make customer support and fleet workflow on track



TS4-S: SAFETY: The TS4-S provides the necessary safety and monitoring services required by municipalities

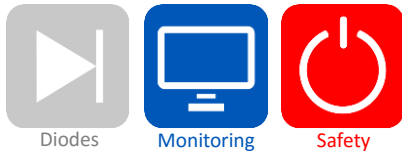

TS4-O: OPTIMIZATION: In addition to safety, monitoring, and PV2.0 synchronization, TS4-O optimizes each PV module when its performance is affected by shade or mismatch



TS4-L: LONG STRINGS: The TS4-L is the complete Smart Module solution. It is ideal for systems requiring fully optimized performance at the module level, monitoring, safety, and longer strings [CLICK HERE](#) to see the TS4-L string sizing info.



MORE INFORMATION:

[Click here](#) to learn more, watch a video and see the TS4 platform datasheet.



2. INSTALLING GATEWAYS (GTWY)

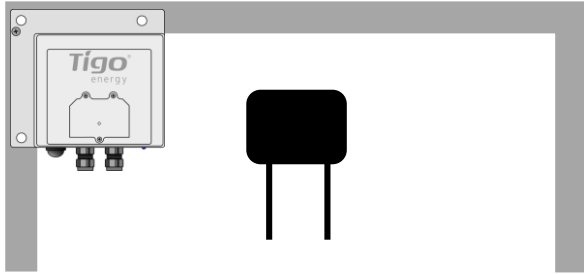

Gateway attaches to module frame using provided bracket

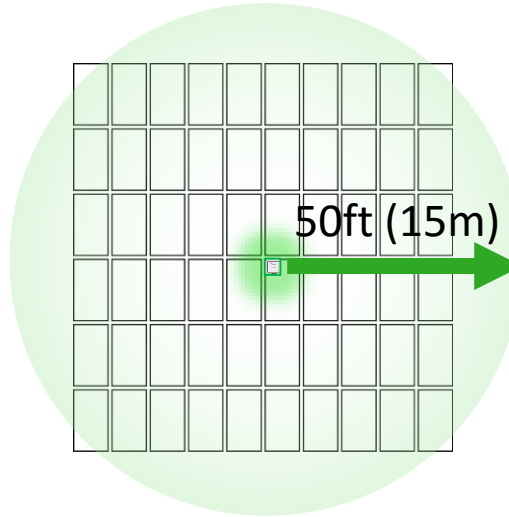

Locate Gateway near center of array or each sub-array

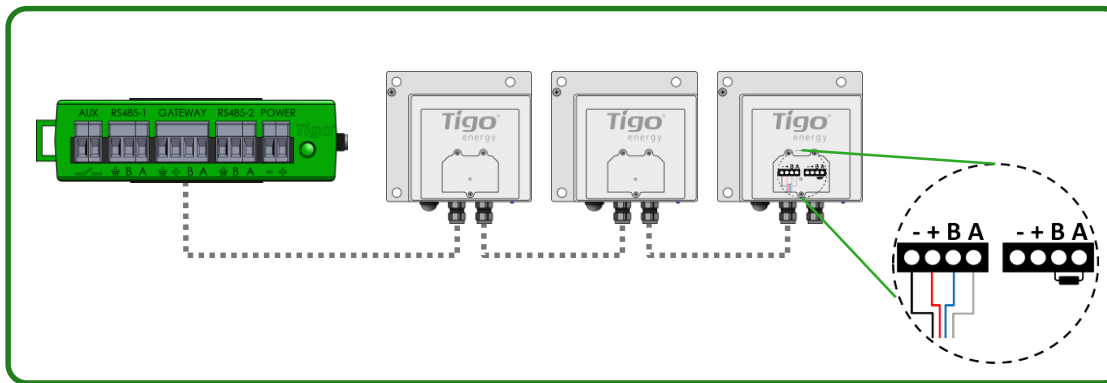

Connect multiple Gateways in series and leave terminating resistor only in final Gateway.

INSTALLATION:

1. Connect all GTWY cables before powering ON Cloud Connect
2. Mount GTWY on back of PV module using provided bracket, or bolt to the racking system
3. Powering ON Cloud Connect and preform GTWY test from the Tigo SMART App

RS-485 communication cable is recommended: 2 x twisted pair, sunlight resistant or direct burial.

MORE INFORMATION

- [Gateway Hardware Guide](#)
- [Gateway Placement Guide](#)
- [Communication Cable Guide](#)

NOTE:

Gateway enclosure can be white or black



3. INSTALLING THE CLOUD CONNECT ADVANCED (CCA)

OPTIONAL

Connect an External Switch for PV-OFF, [click here](#) for instructions

Network
Wired **Ethernet** and **Wi-Fi** connections

1

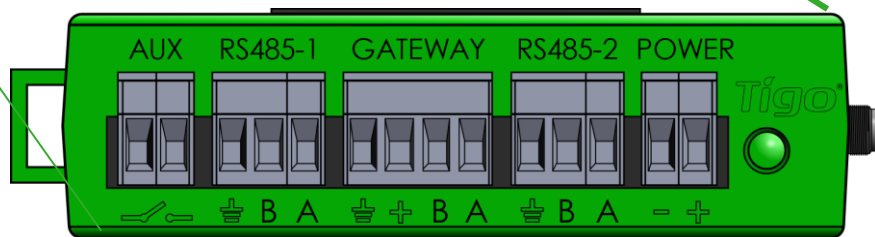

RS485
For 3rd party devices

RS485
For 3rd party devices

Power Supply
24Vdc input

3

Wireless Capabilities
Use Wi-Fi for your Internet connection and for commissioning with a smartphone

Gateway
Plug in GTWY(s) cable after all the GTWY(s) are connected in series (next page)

2

For Rapid Shutdown, install on the same AC panel as the inverter

WHERE TO PLACE:

- On a wall or beam
- Next to the inverter
- **Out of direct sunlight**

3 CONNECTIONS:

1. Internet connection, using one of the options:
 - Ethernet Port
 - Built in Wi-Fi
 - Wi-Fi connection is configured using the Tigo SMART app
2. Gateway
 - Connect using RS485 cable
3. Power supply

*In case CC is mounted in a metal enclosure, extend this antenna out of the box in order to use Wi-Fi as an Internet connection



POWER SUPPLY OPTIONS

Wall Outlet Plug (DC Transformer)		Din Rail	
Tigo Power supply only P/N	983-00070-00	Tigo Power supply only P/N	983-00054-00
Tigo CC Kit P/N	333-00000-10	Tigo CC Kit P/N	333-00000-00
Manufacturer, P/N	Click, CPS024240100*	Manufacturer, P/N	Mean Well, DR-15-24
Input	85-264VAC 47Hz-63Hz	Input	100-240VAC 50Hz/60Hz
Output	24VDC 0.63A	Output	24VDC 1A
Temperature rating	0°C to +45°C	Temperature rating	-20°C to +60°C

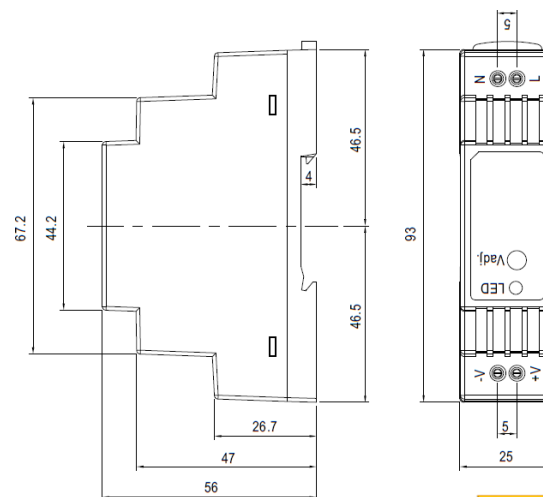
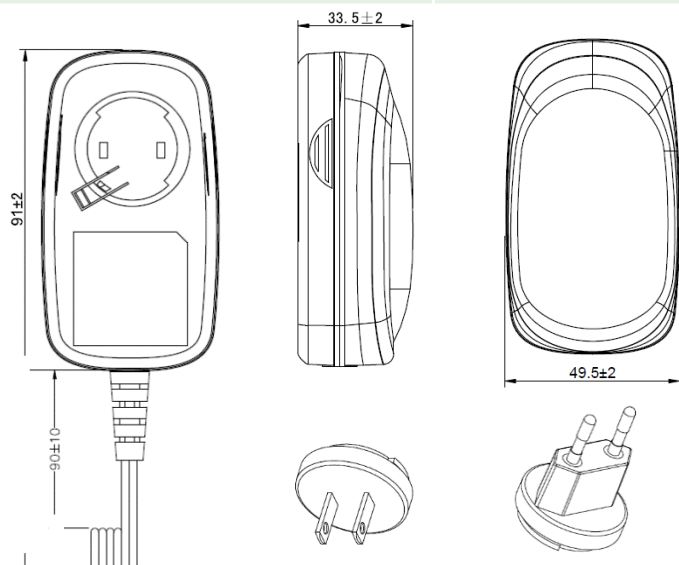

CLOUD CONNECT ADVANCED (CCA) WIRING REFERENCE

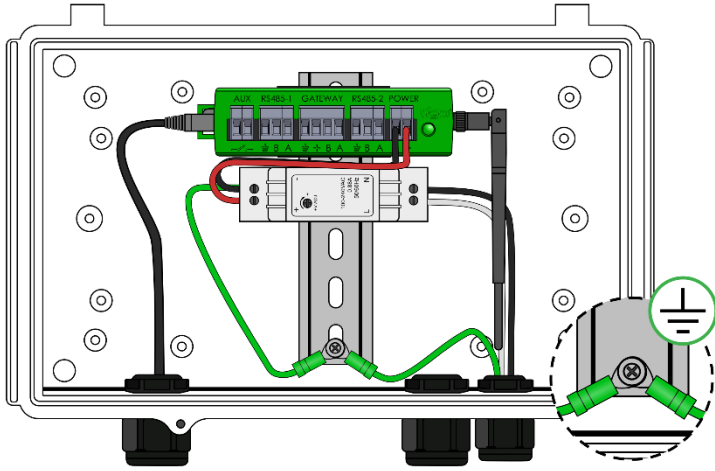

CCA with DIN rail power supply

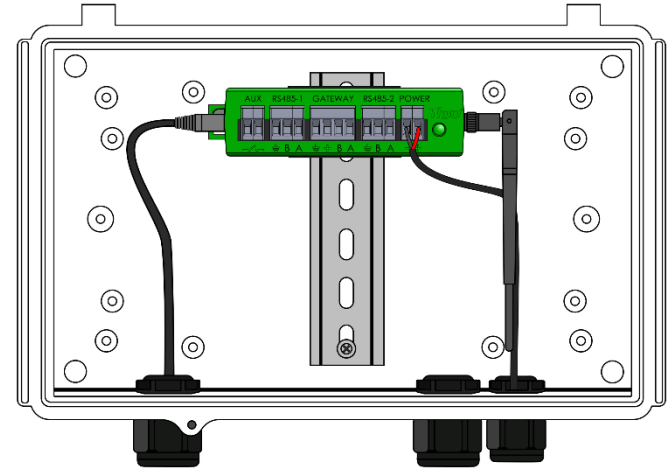









CCA with DC transformer

- Connect DC leads from power supply to CCA
- Connect AC and DC ground wires to DIN rail
- Connect AC power input to power supply
- Connect DC leads from power supply to CCA

[Click here for the Cloud Connect installation quick start guide](#)



CCA LED STATUS INFORMATION

- **Auto PV Safe** 
 - A blinking red and yellow LED indicates that the system automatically entered PV-Safe mode.
- **User PV Safe** 
 - A blinking green and yellow LED indicates that PV-Safe mode was activated manually.
- **SMART App activity** 
 - A blinking green LED indicates that the mobile app is connected to the CCA and is actively in use.
- **Discovery** 
 - A blinking yellow LED indicates that the CCA is scanning for Gateways and smart modules (part of the commissioning process).
- **Error** 
 - A solid red LED indicates that the Discovery process failed or that the CCA is not able to connect to the Tigo server. In case of errors, connect to the CCA using the mobile app for more details.
- **Warning** 
 - A solid yellow LED indicates that: Discovery has not been run, Discovery completed but did not find all expected Gateways or modules, or CCA is not able to upload data. Connect to the CCA using the mobile app for more details.
- **System OK** 
 - A solid green LED indicates that Discovery is complete and found all expected Gateways and smart modules, and CCA is able to connect to the Tigo server.
- **Power Off / No Status** 
 - An unlit LED indicates that the CCA is powered off.



4. INSTALLING: TS4-R

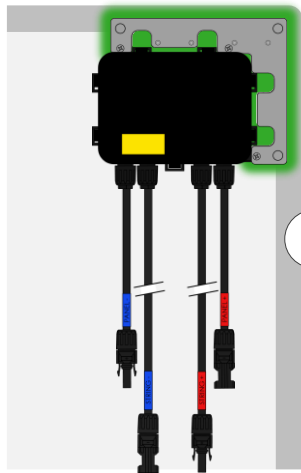

1

Mount the TS4-R on the top right corner of the PV module

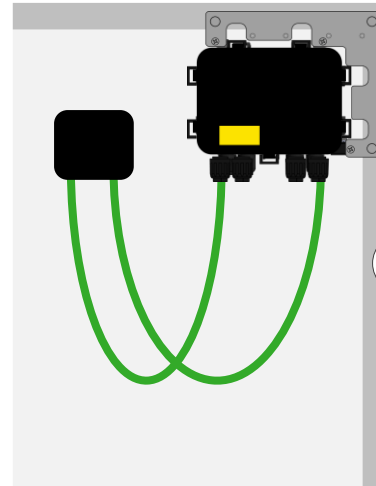

2

Connect the PV cables from the module to the short leads of the TS4-R

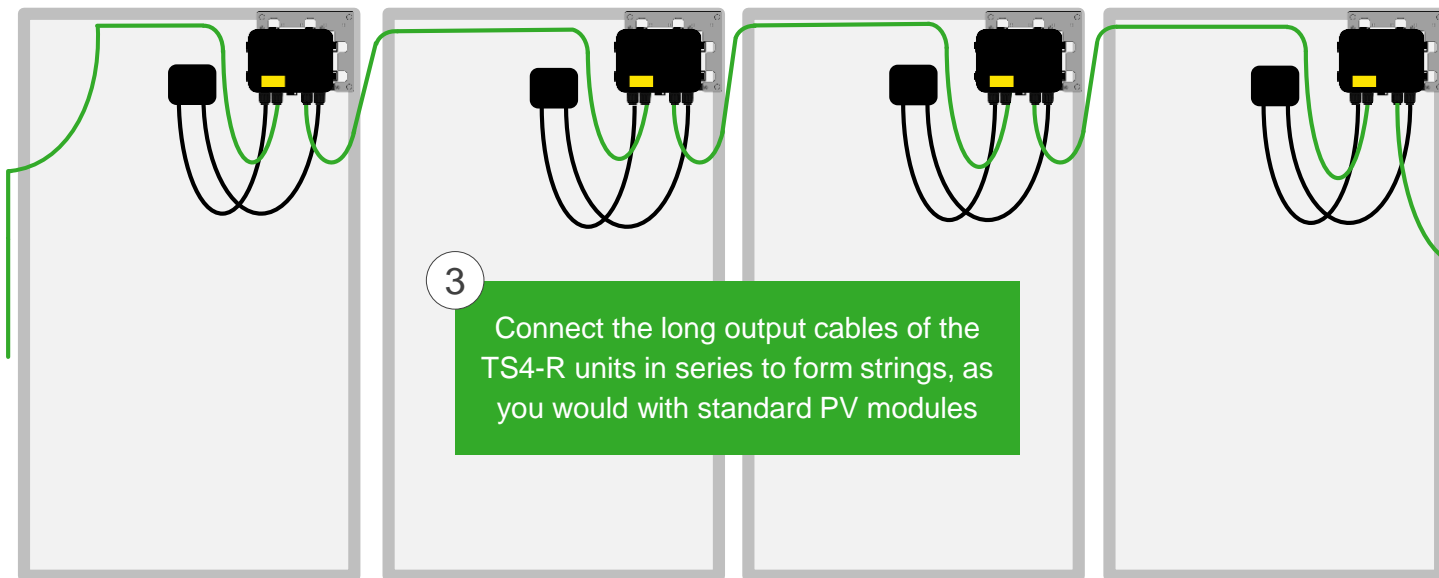

3

Connect the long output cables of the TS4-R units in series to form strings, as you would with standard PV modules



5. MAPPING AND CONFIGURATION OPTIONS

Using Cloud Connect Advanced or Cloud Connect

Systems with <50 TS4 units or less that don't require exact physical positioning of the module

No need to collect and scan barcodes **click here** for instructions



Systems with 50< TS4 units or more, or any time exact physical positioning of modules is necessary

MUST collect barcodes and complete online configuration before commissioning **click here** for instructions



*If using CC (not CCA) you can do this via LCD and buttons, no smart phone needed



5. MAPPING AND CONFIGURATION OPTIONS

Using Cloud Connect Advanced or Cloud Connect

Systems with <50 TS4 units or less that don't require exact physical positioning of the module

Systems with 50< TS4 units or more, or any time exact physical positioning of modules is necessary

PLEASE SELECT one of the two processes in order to continue

No need to collect and scan barcodes **click here** for instructions



MUST collect barcodes and complete online configuration before commissioning **click here** for instructions



*If using CC (not CCA) you can do this via LCD and buttons, no smart phone needed



5. MAPPING



Remove 1 barcode sticker from the TS4 junction box or TS4-R add-on

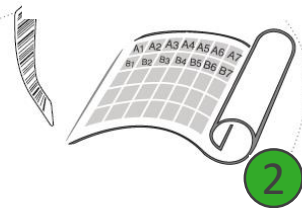

Place the sticker on the map, string list or construction drawing, in the exact position you are going to place modules in the field or on the roof.

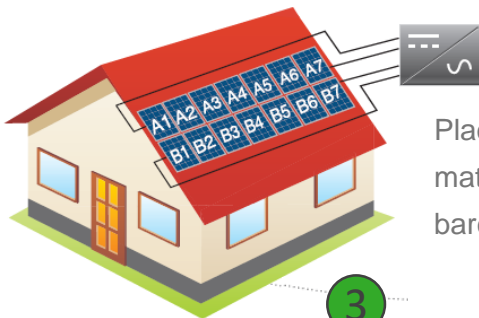

Place PV modules in a way matches the map you made using barcodes.

Also record the serial numbers of the GTWY(s)

TEMPLATES:

Create your site map using Tigo's string list template

To view and download, [CLICK HERE](#)

Another option is to first map your site online (see next page). At the end, you'll be able to download a physical map of your system to help map the barcodes

MAKE SURE you take the TS4 junction box's label or the TS4-R label, **NOT** the PV module's



5. ONLINE CONFIGURATION

To configure a system
go to
www.tigoenergy.com
and select “Sign In”

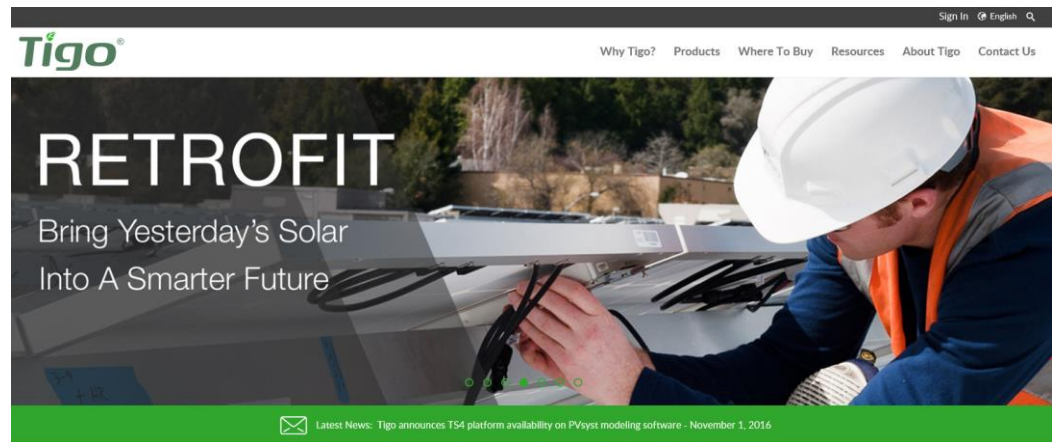

LOGIN

You can either use your existing Tigo account, or create a new one by pressing “New Installer” at the top

Tigo[®]
energy

English (North America ▾)

[Click Here to View Existing Installations](#)

[See Dramatic ROI and Safety Improvements](#) **NEW!**

[New Installer? Sign Up](#)

Login ID

Password

[Forgot Password](#)

[Login](#)

Optimized by Tigo Energy. Copyright © 2007-2013 Tigo Energy, Inc. All rights reserved. [Privacy Policy](#)



NEW INSTALLATION

Scroll to the bottom of the page to find the “New installation” button, and click it to begin.

Have your site map or string list with bar codes ready.

The screenshot shows the 'My Installations' page in the Tigo Energy web application. At the top, there is a navigation bar with the Tigo Energy logo and 'My Installations' text. Below this is a search bar and a world map with several green location markers. A table below the map lists existing installations with columns for Job ID, System ID, Site Name, and Actions. At the bottom right of the page, there are two buttons: 'New Installation' and 'Create site with CSV file'. A green arrow points to the 'New Installation' button.

Job ID	System ID	Site Name	Actions
21045	1045	Tigo Roof Debug 1	Delete
23996	3996	Lafite 3-P Pole Mount	Delete
0001	5717	Kevonh Aules	Delete
25718	5718	Tigo LG Office Temp	Delete
27426	7426	Tigo Lab Test	Delete
27453	7453	Josh Test 1	Delete
27454	7454	Josh Test 2	Delete
27455	7455	Josh Test 3	Delete
29589	9589	Novati	Configure Delete



TIP: USE A BARCODE SCANNER

Use a barcode scanner to save time and avoid typos
Easy to use, simply plug and play



INSTALLATION WIZARD

Follow the instructions
of the installation
wizard

[Click here](#) for a
detailed walk through

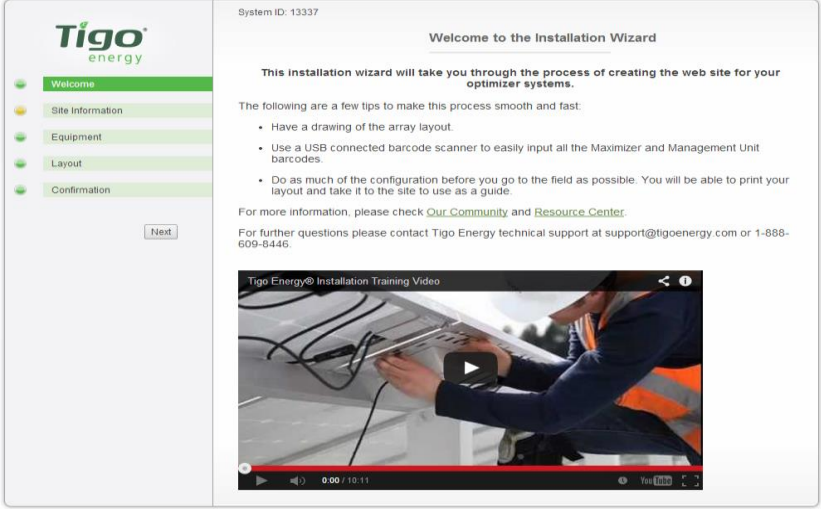

The screenshot displays the Tigo Energy Installation Wizard interface. On the left, the Tigo Energy logo is visible above a vertical navigation menu with five items: Welcome (highlighted in green), Site Information, Equipment, Layout, and Confirmation. A 'Next' button is located below the menu. The main content area on the right is titled 'Welcome to the Installation Wizard' and includes the System ID '13337'. It contains a welcome message, a list of tips for a smooth installation process, and contact information for technical support. At the bottom of the main area, there is an embedded video player showing a person working on solar panel equipment, with a play button in the center and a progress bar at the bottom.

System ID: 13337

Welcome to the Installation Wizard

This installation wizard will take you through the process of creating the web site for your optimizer systems.

The following are a few tips to make this process smooth and fast:

- Have a drawing of the array layout.
- Use a USB connected barcode scanner to easily input all the Maximizer and Management Unit barcodes.
- Do as much of the configuration before you go to the field as possible. You will be able to print your layout and take it to the site to use as a guide.

For more information, please check [Our Community](#) and [Resource Center](#).

For further questions please contact Tigo Energy technical support at support@tigoenergy.com or 1-888-609-8446.

Tigo Energy® Installation Training Video



CONFIGURE THE SYSTEM

Enter site information:

Address

Site owner information

3rd party finance, if
such exists

Click Next

System ID: 3877

Site Information

Site Address



You can adjust the location manually by dragging the marker on the map (optional)

* Country:

* Street:

* City:

* State:

* Zip Code:

* Site Timezone:

Installer Information

* Site Name:

Job ID:



CONFIGURE THE SYSTEM

Enter inverter
information

Tigo
energy

- Welcome
- Site Information
- Equipment**
- Layout
- Confirmation

System ID: 13337

Equipment

Inverter



* **Label:**

* **Manufacturer:**

* **Model:**

* **Max Power:** Watts

* **Number of MPPTs:**

* **Number of strings:**

* **Modules per string:** Using variable string lengths?

* **MPPT Low:** Volts

* **MPPT High:** Volts



CONFIGURE THE SYSTEM

Enter inverter
information

* Label:

* Manufacturer:

* Model:

* Max Power: Watts

* Number of MPPTs:

* Number of strings:

* Modules per string: [Using variable string lengths?](#)

* MPPT Low: Volts

* MPPT High: Volts



CONFIGURE THE SYSTEM

Enter inverter
information

After choosing model
the following will auto-
fill

* <u>Label:</u>	<input type="text" value="SMA"/>
* <u>Manufacturer:</u>	<input type="text" value="SMA"/>
* <u>Model:</u>	<input type="text" value="SB3000"/>
* <u>Max Power:</u>	<input type="text" value="3150"/> Watts
* <u>Number of MPPTs:</u>	<input type="text" value="1"/>
* <u>Number of strings:</u>	<input type="text"/>
* <u>Modules per string:</u>	<input type="text"/> Using variable string lengths?
* <u>MPPT Low:</u>	<input type="text" value="200"/> Volts
* <u>MPPT High:</u>	<input type="text" value="400"/> Volts
<input type="button" value="Add Inverter"/>	



CONFIGURE THE SYSTEM

Enter string information per chosen inverter

* Label:

* Manufacturer:

* Model:

* Max Power: Watts

* Number of MPPTs:

* Number of strings:

* Modules per string: [Using variable string lengths?](#)

* MPPT Low: Volts

* MPPT High: Volts

CONFIGURE THE SYSTEM

Enter string information per chosen inverter

* Label:

* Manufacturer:

* Model:

* Max Power: Watts

* Number of MPPTs:

* Number of strings: If your strings are uneven press

* Modules per string:

* MPPT Low: Volts

* MPPT High: Volts



CONFIGURE THE SYSTEM

Enter string information per chosen inverter

* **Model:** SB3000 ▼

* **Max Power:** 3150 Watts

* **Number of MPPTs:** 1 ▼

* **Number of strings:** 2

* **Modules per string:**

[Using same string lengths?](#)

* **MPPT Low:** 200 Volts

* **MPPT High:** 400 Volts

Please enter the number of modules in each string:

String 1

String 2

If you're strings are uneven press



CONFIGURE THE SYSTEM

And fill the number of modules per string

* **Model:**

* **Max Power:** Watts

* **Number of MPPTs:**

* **Number of strings:**

* **Modules per string:** [Using same string lengths?](#)

* **MPPT Low:** Volts

* **MPPT High:** Volts

Please enter the number of modules in each string:

String 1

String 2



CONFIGURE THE SYSTEM

Once done, click “Add inverter” and scroll down to modules’ section.

* **Model:** SB3000

* **Max Power:** 3150 Watts

* **Number of MPPTs:** 1

* **Number of strings:** 2

* **Modules per string:** [Using same string lengths?](#)

* **MPPT Low:** 200 Volts

* **MPPT High:** 400 Volts

Please enter the number of modules in each string:

String 1

String 2

Add Inverter



CONFIGURE THE SYSTEM

Enter PV module information

Module



* **Manufacturer:**

* **Model:**

* **Module Power (DC):** Watts

Connector Type:



CONFIGURE THE SYSTEM

Enter PV module information

*** Manufacturer:**

*** Model:**

*** Module Power (DC):** Watts

Connector Type:



CONFIGURE THE SYSTEM

Enter PV module information

After choosing model the following will auto-fill

* Manufacturer:

* Model:

* Module Power (DC): Watts

Connector Type:



CONFIGURE THE SYSTEM

Select connector type

* <u>Manufacturer:</u>	Trina Solar ▼
* <u>Model:</u>	TSM-250 PA05.28 ▼
* <u>Module Power (DC):</u>	250 Watts
<u>Connector Type:</u>	Please Select a Connector Type ▼

Add Module Type



CONFIGURE THE SYSTEM

Once done, click 'Add Module Type' and scroll down to MMU section.

* Manufacturer:

* Model:

* Module Power (DC): Watts

Connector Type:



CONFIGURE THE SYSTEM

This section says Management Unit and refers to both Cloud Connect (CC) and Cloud Connect Advanced (CCA)

Enter CC or CCA information

Management Unit

Select Number of Management Units
This configuration requires a minimum of 1 Management Unit and 0 Gateway. 1 Management Unit supports 360 Maximizers, and 1 Gateway supports 120 Maximizers.

1 ▾

Enter Management Unit Barcode

Label	* Barcode	* No. of Gateways	Actions
MMU 1	04C05B802410	1 ▾	Replace

Register MMU(s)



Mac ID on the bottom of the unit



CONFIGURE THE SYSTEM

Tigo CCC and CCA have a 12 digit MAC IDs

The MAC ID of the unit is located on the right hand side of the CC or CCA

You can use your barcode scanner to insert the MAC ID



CONFIGURE THE SYSTEM

Once done, scroll back up and click 'Next' on the left

System ID: 13337

Equipment

Inverter

* Label: SMA

* Manufacturer: SMA

* Model: SB3000

* Max Power: 3150 Watts

* Number of MPPTs: 1

* Number of strings: 2

* Modules per string: Using same string lengths?

* MPPT Low: 200 Volts

* MPPT High: 400 Volts

Please enter the number of modules in each string:

String 1: 9

String 2: 11

Add Inverter

Module



CONFIGURE THE SYSTEM

Keep on your maps the Gateway's MAC ID:
Tigo Gateways have 16 digit MAC IDs
Located on the on housing of gateway



CONFIGURE THE SYSTEM

Enter layout
information

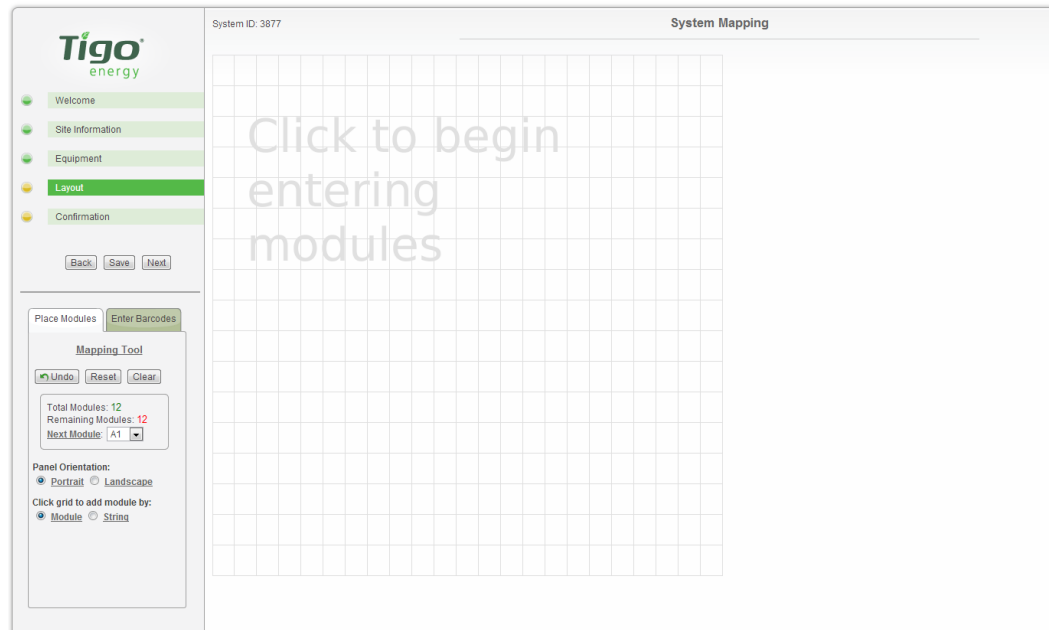

Tigo energy

System ID: 3877 System Mapping

Welcome
Site Information
Equipment
Layout
Confirmation

Back Save Next

Place Modules Enter Barcodes

Mapping Tool

Undo Reset Clear

Total Modules: 12
Remaining Modules: 12
Next Module: A1

Panel Orientation:
 Portrait Landscape

Click grid to add module by:
 Module String

Click to begin entering modules



CONFIGURE THE SYSTEM

Click the grid to begin placing the modules as they appear on the roof

System ID: 3877

System Mapping

Tigo
energy

- Welcome
- Site Information
- Equipment
- Layout**
- Confirmation

Place Modules

Mapping Tool

Total Modules: 12
Remaining Modules: 12
Next Module: A1

Panel Orientation:
 Portrait Landscape

Click grid to add module by:
 Module String

Click to begin entering modules



CONFIGURE THE SYSTEM

Click the grid to begin placing the modules as they appear on the roof

Use the bottom part to choose how to place the modules

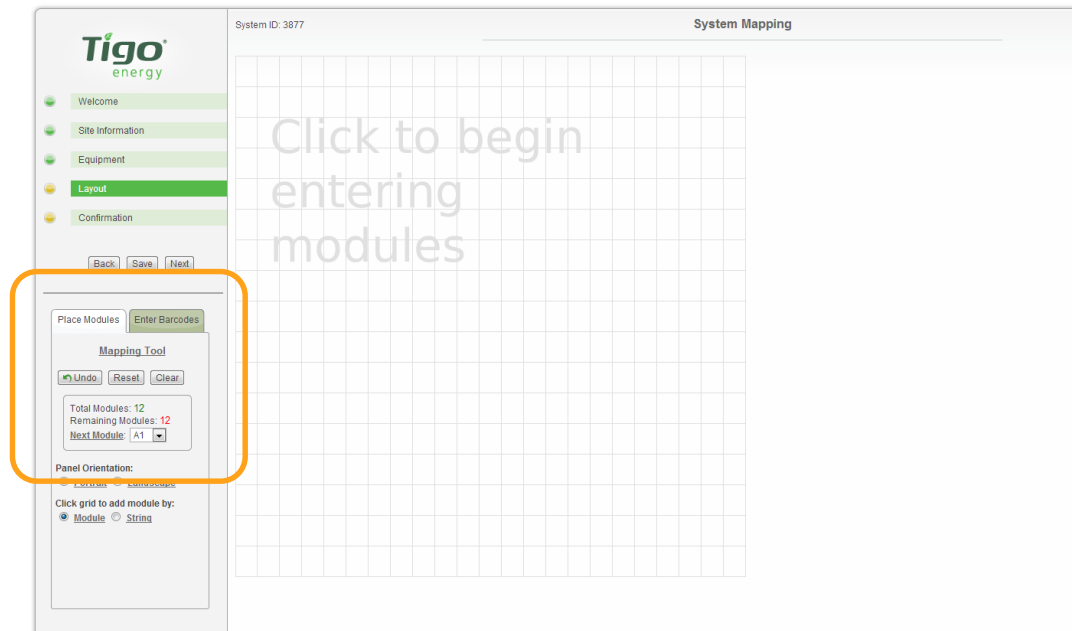

CONFIGURE THE SYSTEM

You can place the module in portrait or landscape

Place Modules Enter Barcodes

Mapping Tool

Undo Reset Clear

Total Modules: 20
Remaining Modules: 0
Next Module: ▼

Panel Orientation:
 Portrait Landscape

Click grid to add module by:
 Module String



CONFIGURE THE SYSTEM

You can choose to place a single module per click, or a string at a click

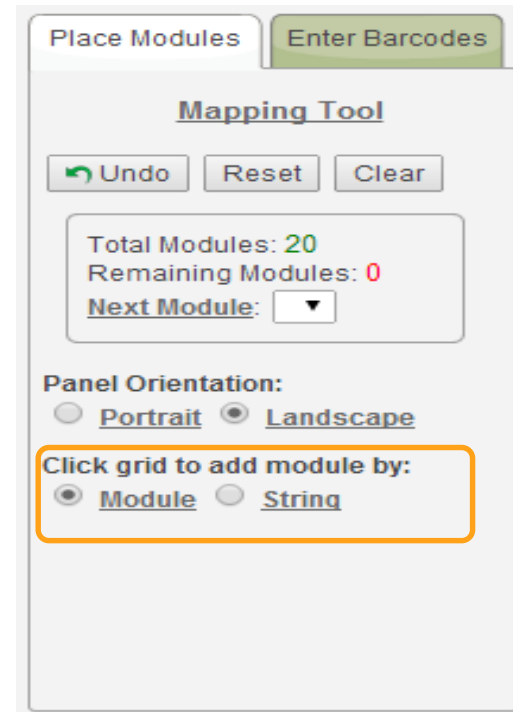

The screenshot shows a software interface for configuring a system. At the top, there are two tabs: "Place Modules" and "Enter Barcodes". Below the tabs is a section titled "Mapping Tool". Inside this section, there are three buttons: "Undo", "Reset", and "Clear". Below the buttons is a box containing the following information: "Total Modules: 20", "Remaining Modules: 0", and "Next Module:" followed by a dropdown menu. Below this box is the "Panel Orientation:" section, which has two radio buttons: "Portrait" and "Landscape", with "Landscape" selected. At the bottom of the interface, there is a section titled "Click grid to add module by:" with two radio buttons: "Module" and "String", with "Module" selected. This section is highlighted with an orange border.



CONFIGURE THE SYSTEM

If you choose a string you'll get to choose the direction in which the modules will be placed

The screenshot shows a software interface with two tabs: "Place Modules" and "Enter Barcodes". The "Enter Barcodes" tab is active. Below the tabs is a section titled "Mapping Tool".

At the top of the "Mapping Tool" section are three buttons: "Undo", "Reset", and "Clear".

Below the buttons is a box containing the following information:

- Total Modules: 20
- Remaining Modules: 0
- Next String: [dropdown menu]

Below this box are two sections of radio button options:

Panel Orientation:

- Portrait
- Landscape

Click grid to add module by:

- Module
- String

Below these options is a section titled "String Direction:" which is highlighted with an orange border. It contains five radio button options with corresponding arrows:

- (Right)
- ← (Left)
- ↓ (Down)
- ↑ (Up)



CONFIGURE THE SYSTEM

Once done with the physical layout it's time to upload the barcodes

The screenshot shows the Tigo Energy web interface for configuring a system. The page title is "Assign Maximizer IDs" and the system ID is 13337. The left sidebar contains a navigation menu with the following items: Welcome, Site Information, Equipment, Layout (highlighted), and Confirmation. Below the menu are "Back", "Save", and "Next" buttons. The main content area is a large grid for assigning maximizer IDs. The grid has 11 columns labeled A1 through B1. The first row is highlighted in green, and the first cell (A1) is also highlighted in green. Below the grid, there are two tabs: "Place Modules" (highlighted with a red box) and "Enter Barcodes". Under "Place Modules", there is a "Maximizer Barcode" input field with a placeholder "Scan, type or use smart phone". Below that, there is a section for "Assigning via CSV" with "Step 1: Download template" containing a dropdown menu set to "For All MMUs" and a "Download" button. "Step 2: Scan or enter barcodes in Barcode column of the downloaded template." and "Step 3: Upload completed file:" are also present, with a "Choose File" button and "No file chosen" text, and an "Upload" button.



CONFIGURE THE SYSTEM

Map with barcodes from the installation site should show how the panels are wired

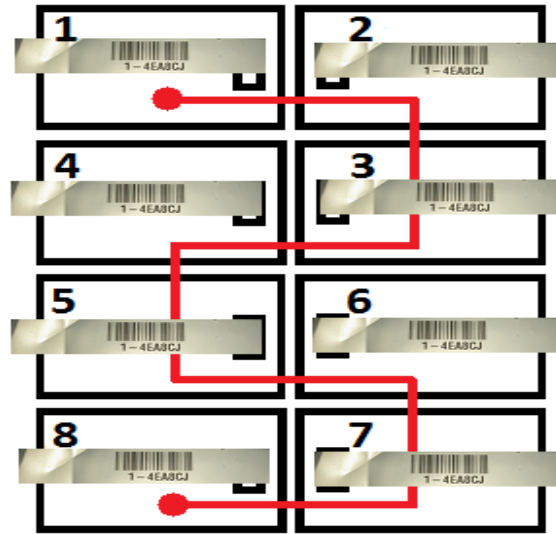

CONFIGURE THE SYSTEM

There are 2 ways to enter the barcodes:

Place Modules Enter Barcodes

Module A1
Maximizer Barcode:

Assigning via CSV
Step 1: Download template:

Step 2: Scan or enter barcodes in Barcode column of the downloaded template.

Step 3: Upload completed file:
 No file chosen



CONFIGURE THE SYSTEM

There are 2 ways to enter the barcodes:

1. By scanning or typing the barcodes in the upper section based on the map

Place Modules Enter Barcodes

Module A1
Maximizer Barcode:

Assigning via CSV
Step 1: Download template:

Step 2: Scan or enter barcodes in Barcode column of the downloaded template.

Step 3: Upload completed file:
 No file chosen



CONFIGURE THE SYSTEM

There are 2 ways to enter the barcodes:

2. By downloading a template, scanning barcodes into it while on site and later uploading it

Place Modules Enter Barcodes

Module A1
Maximizer Barcode:
Scan, type or use smart phone

Assigning via CSV
Step 1: Download template:
For All MMUs Download
Step 2: Scan or enter barcodes in Barcode column of the downloaded template.
Step 3: Upload completed file:
Choose File No file chosen
Upload



CONFIGURE THE SYSTEM

Once done uploading the barcodes you'll see the modules have all turned green

The screenshot shows the Tigo energy web interface for configuring a system. The system ID is 13337. The page title is "Assign Maximizer IDs". The left sidebar contains a navigation menu with "Layout" selected. The main area displays a grid of module positions, with the first two rows (A2-A9 and B1-B11) highlighted in green, indicating they are configured. The bottom section shows "Module A1" with a "Maximizer Barcode" field containing "0-103B4DF7J". Below this, there are instructions for "Assigning via CSV" with a "Download" button for a template.

System ID: 13337

Assign Maximizer IDs

	A2	A3	A4	A5	A6	A7	A8	A9						
B1	B2	B3	B4	B5	B6	B7	B8	B9	B10	B11				

Back Save Next

MAC IDs autosaved

Place Modules Enter Barcodes

Module A1
Maximizer Barcode:
0-103B4DF7J

Assigning via CSV
Step 1: Download template:
For All MMUs [v] Download

Step 2: Scan or enter barcodes in Barcode column of the downloaded template.



CONFIGURE THE SYSTEM

Review summary and confirm



System ID: 13337

Confirmation

Congratulations! System configuration is complete now.

Next Steps:

- Download [System Mapping](#) and [Maximizer Barcodes](#).
- Plug in Management Unit and connect to internet to enable automatic configuration download

Job Information	
Demo Room @Tigo Los Gatos	
System Size	5 kW
Total Modules	20
Total Inverters	1
Total Strings	2

Management Unit Data			
Management Unit	# Gateways	# Modules	# Strings
MMU 1: 04C05B802410	1	20	2
Total	1	20	2

[Back](#) [Finish](#)



CONFIGURE THE SYSTEM

You can download a map of your system

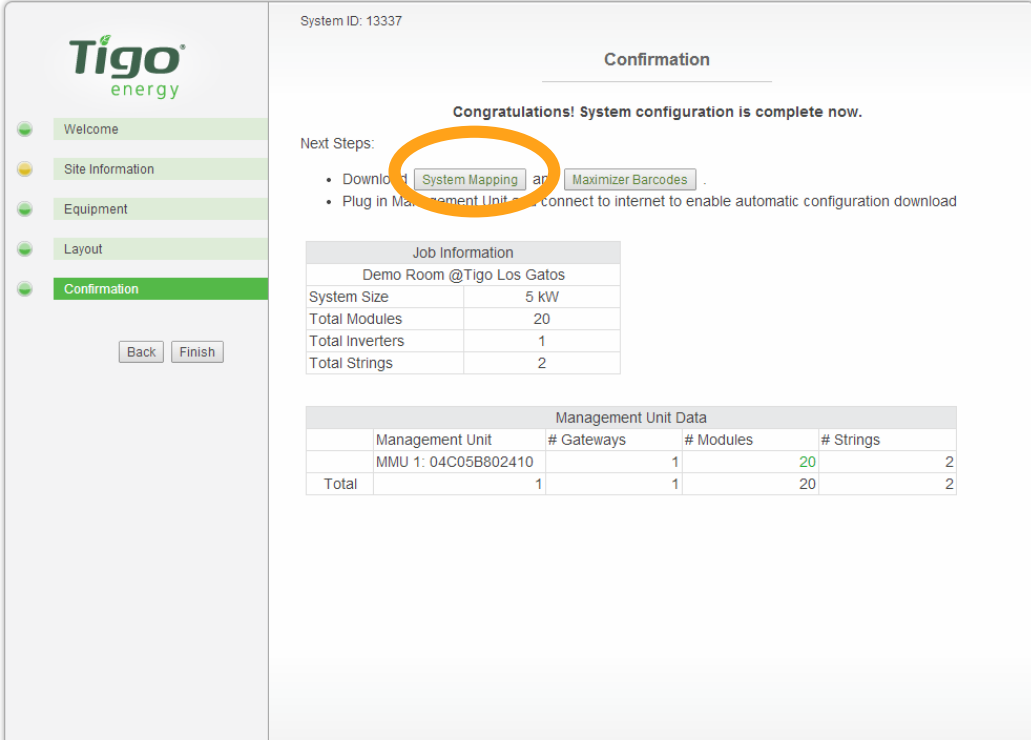

System ID: 13337

Confirmation

Congratulations! System configuration is complete now.

Next Steps:

- Download [System Mapping](#) and [Maximizer Barcodes](#).
- Plug in Management Unit to connect to internet to enable automatic configuration download.

Job Information	
Demo Room @Tigo Los Gatos	
System Size	5 kW
Total Modules	20
Total Inverters	1
Total Strings	2

Management Unit Data			
Management Unit	# Gateways	# Modules	# Strings
MMU 1: 04C05B802410	1	20	2
Total	1	20	2

Back Finish



CONFIGURE THE SYSTEM

You can download a map of your system

The screenshot shows the Tigo energy system configuration interface. On the left is a navigation menu with steps: Welcome, Site Information, Equipment, Layout, and Confirmation (highlighted). The main content area shows 'System ID: 13337' and a 'Confirmation' section with the message: 'Congratulations! System configuration is complete now.' Below this, 'Next Steps:' includes a circled 'System Mapping' button and a 'Maximizer Barcodes' button. A 'Job Information' table is displayed:

Job Information	
Demo Room @Tigo Los Gatos	
System Size	5 kW
Total Modules	20
Total Inverters	1
Total Strings	2

Below the job information is a 'Module Data' table:

Module Data		
	# Modules	# Strings
1	20	2
1	20	2

At the bottom of the interface, a 'System Mapping: Demo Room @Tigo Los Gatos' window is shown, containing a grid of module positions labeled A1 through B11:

A1	A2	A3	A4	A5	A6	A7	A8	A9			
B1	B2	B3	B4	B5	B6	B7	B8	B9	B10	B11	



CONFIGURE THE SYSTEM

And a table
referencing of your
map and barcodes

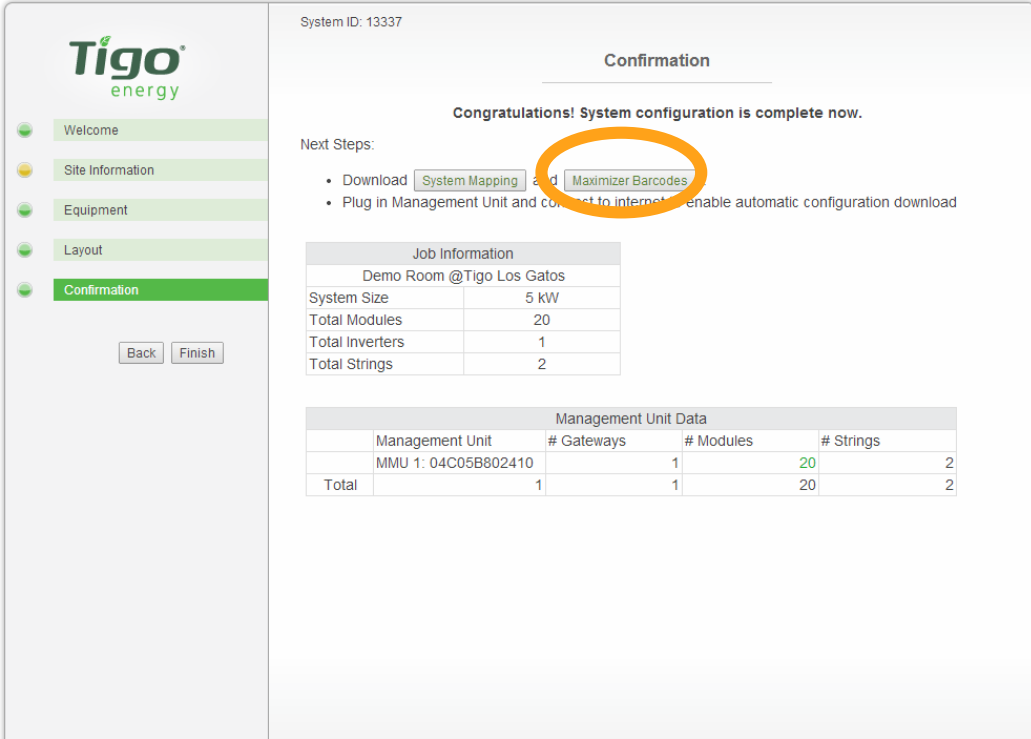

System ID: 13337

Confirmation

Congratulations! System configuration is complete now.

Next Steps:

- Download [System Mapping](#) and [Maximizer Barcodes](#)
- Plug in Management Unit and connect to internet to enable automatic configuration download

Job Information	
Demo Room @Tigo Los Gatos	
System Size	5 kW
Total Modules	20
Total Inverters	1
Total Strings	2

Management Unit Data			
Management Unit	# Gateways	# Modules	# Strings
MMU 1: 04C05B802410	1	20	2
Total	1	20	2

Back Finish



CONFIGURE THE SYSTEM

And a table
referencing of your
map and barcodes

System ID: 13337

Confirmation

Congratulations! System configuration is complete now.

Next Steps:

- Download [System Mapping](#) and [Maximizer Barcodes](#)
- Plug in Management Unit and connect to internet to enable automatic configuration download

Job Information	
Demo Room @Tigo Los Gatos	
System Size	5 kW
Total Modules	20

Modules	# Strings
20	2
20	2

Tigo energy System Maximizers: Demo Room @Tigo Los Gatos

MMU: 04C05B802410

A1	0-103B4DF7J	B1	0-103B4E0FX
A2	0-103B4E09P	B2	0-103B4E21N
A3	0-103B4E25T	B3	0-103B4E00Z
A4	0-103B4DF6H	B4	0-103B4E23G
A5	0-103B4D8EJ	B5	0-103B4E13Z
A6	0-103B4DECW	B6	0-103B4E39R



CONFIGURE THE SYSTEM – DONE!

Once done, press
Finish

Your system is now
ready to be
discovered!

System ID: 13337

Confirmation

Congratulations! System configuration is complete now.

Next Steps:

- Download [System Mapping](#) and [Maximizer Barcodes](#) .
- Plug in Management Unit and connect to internet to enable automatic configuration download

Job Information	
Demo Room @Tigo Los Gatos	
System Size	5 kW
Total Modules	20
Total Inverters	1
Total Strings	2

Management Unit Data			
Management Unit	# Gateways	# Modules	# Strings
MMU 1: 04C05B802410	1	20	2
Total	1	20	2

Back Finish



6. COMMISSION

DOWNLOAD THE TIGO SMART APP

Go to the App Store or Google Play and search for 'Tigo SMART'

Download the app and open it once the installation process is complete



Using a Cloud Connect with LCD and buttons and wish to commission without the app? [Click here](#)

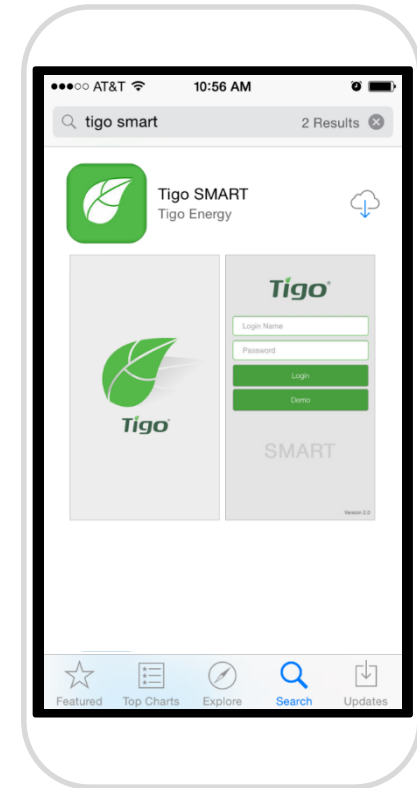

ENTER YOUR USERNAME AND PASSWORD, AND PRESS 'LOGIN'

Requires active mobile data connection

This is the same username and password
created for the online configuration at:

<https://installations.tigoenergy.com/base/login/>

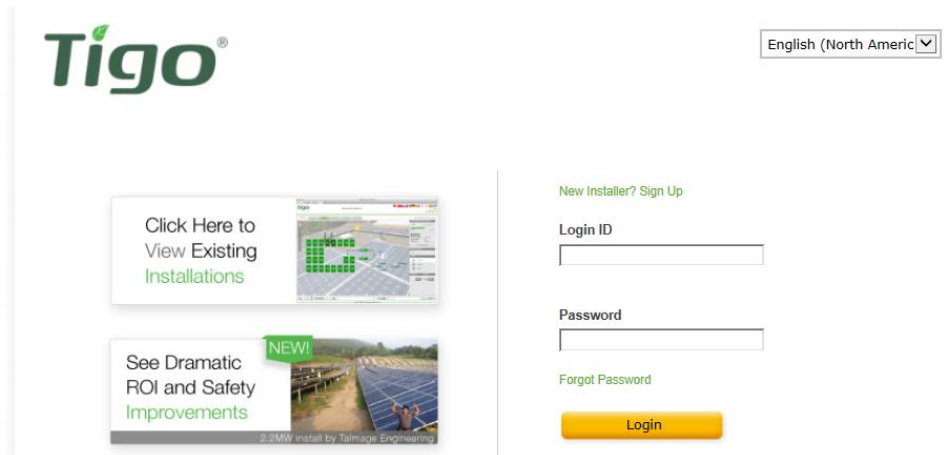
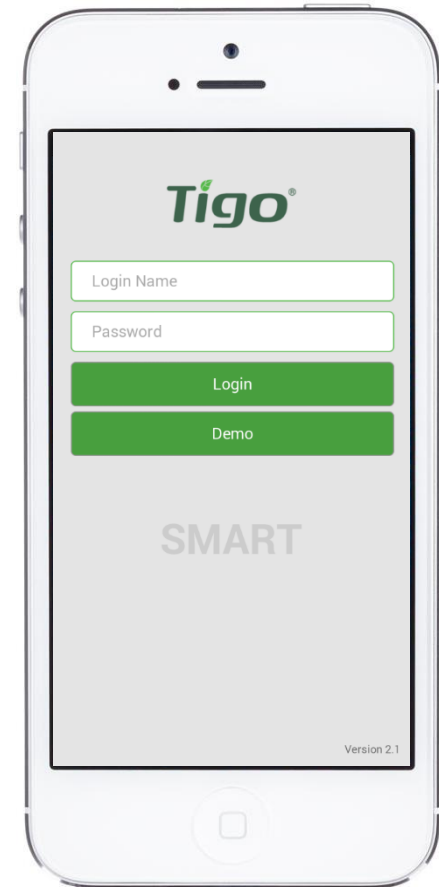

PRESS 'INSTALLATION'

Requires active mobile data connection

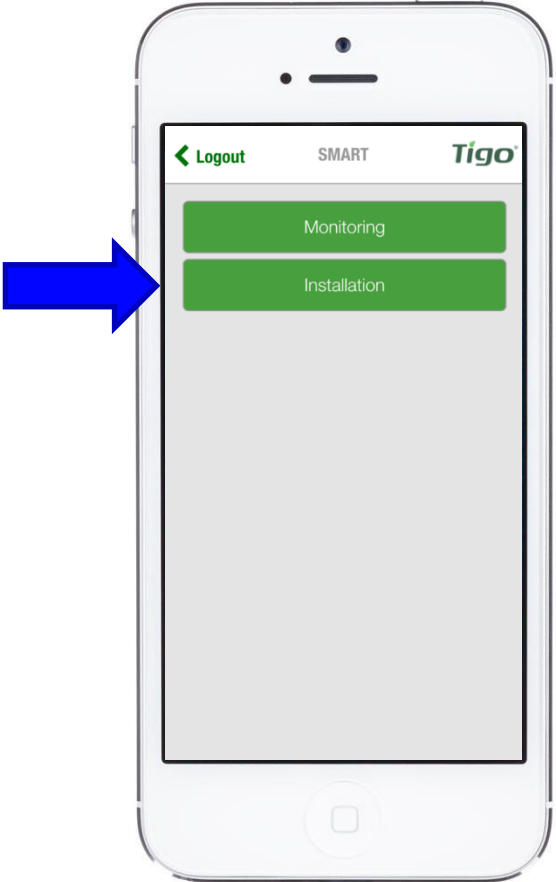

SETUP NEW SYSTEM

Requires active mobile data connection

- To proceed with a new installation, select 'Setup New System'
- Select 'Service Existing System' to service a Cloud Connect that has already been configured

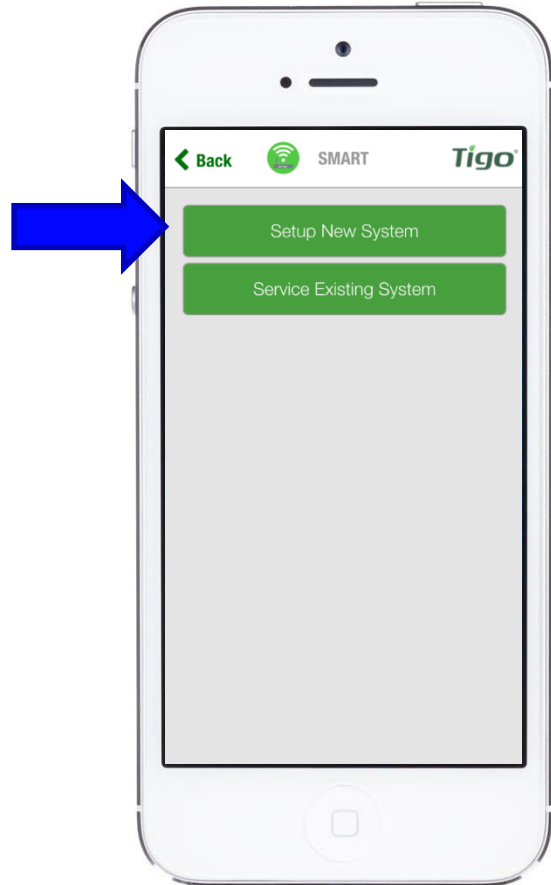

CONFIRM SYSTEM SIZE

Requires active mobile data connection

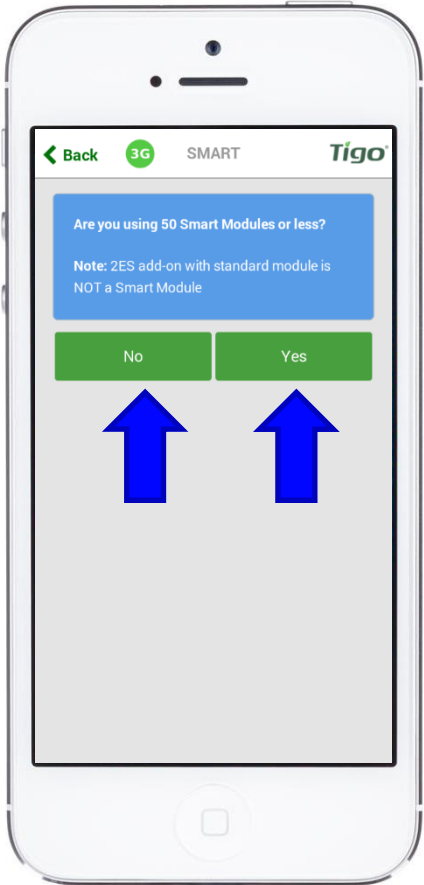

CONFIRM CONFIGURATION

Requires active mobile data connection

- Since you already scanned barcodes and configured the system online, select 'Yes' and then connect your Smartphone to the Cloud Connect hotspot to proceed

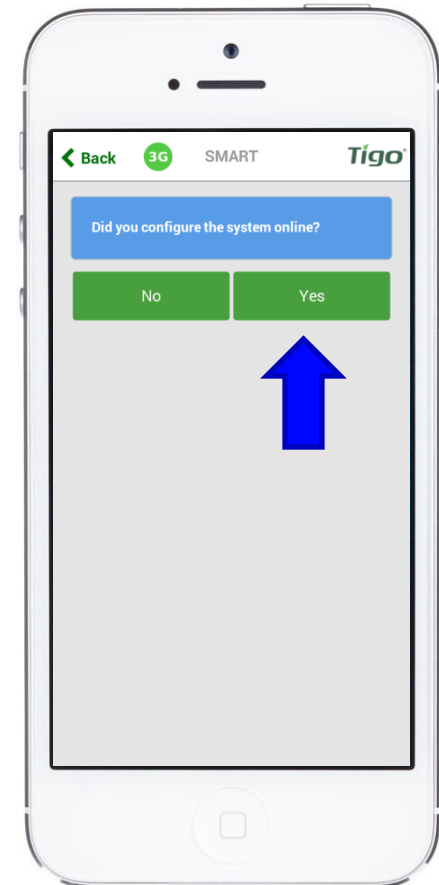

CONNECT YOUR SMARTPHONE TO THE CLOUD CONNECT VIA WI-FI

Requires direct Wi-Fi connection to Cloud Connect

- Enable Wi-Fi in your Smartphone settings (requires to leave the app, but don't close it)
- Locate a Wi-Fi network named SM-XXXXXXXXXXXX and connect to it
- Press 'Connect' to continue

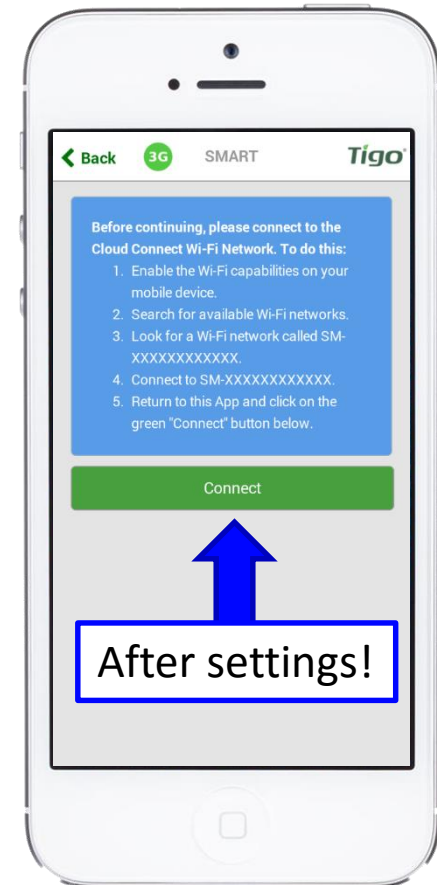

NEXT STEP: SETUP INTERNET

CONNECTION

Requires direct Wi-Fi connection to Cloud Connect

- Select your preferred method of connecting to the internet:
 - Wired: using Ethernet cable
 - Wireless: Using Wi-Fi

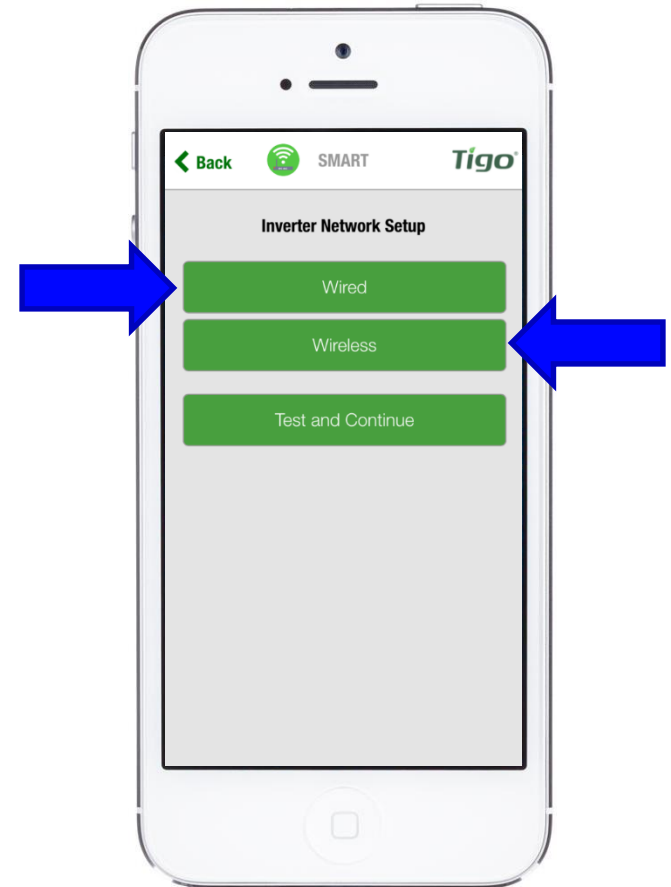

SELECTING WIRED INTERNET

CONNECTION

Requires direct Wi-Fi connection to Cloud Connect

- Open up the following screen
- The app will look for an available internet connection automatically
- Scroll down and press 'Test and Continue'
- Wired connections can be configured for Dynamic (DHCP) or Static IP in the app

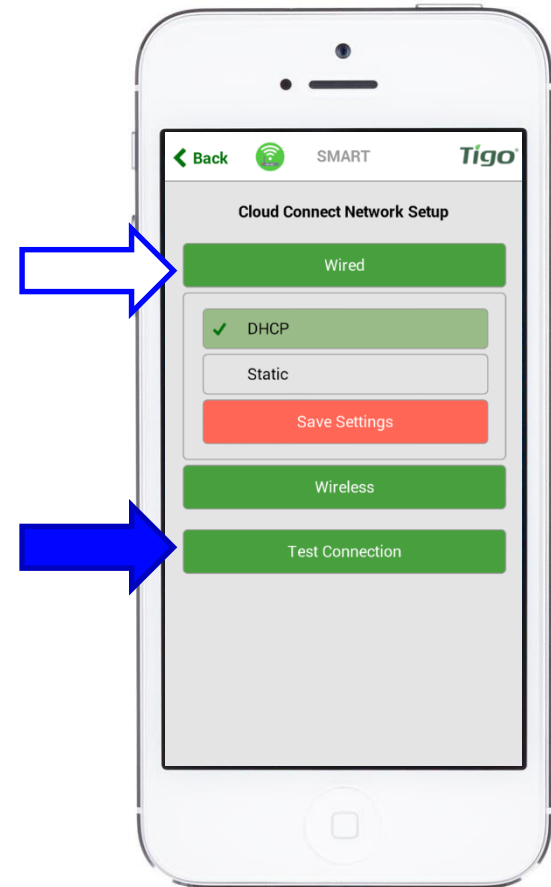

SELECTING WIRELESS INTERNET

CONNECTION

Requires direct Wi-Fi connection to Cloud Connect

- Opens up a screen showing the available wireless Internet connections
- Make sure you have the name and password for the home network
 - Please note that WPS is not supported by the Cloud Connect
- After selecting a wireless network press 'Test and Continue'



NETWORK TEST WILL RUN FOR SEVERAL SECONDS

Requires direct Wi-Fi connection to Cloud Connect

- The Network Test can diagnose problems with the Internet connection
- Please note that when the Cloud Connect is mounted inside a metal enclosure, it may not receive a Wi-Fi signal unless the antenna is mounted outside of the enclosure.
 - Extension cables for the Wi-Fi antenna and a matching cable gland can be purchased from Tigo, P.N. 006-90029-00.

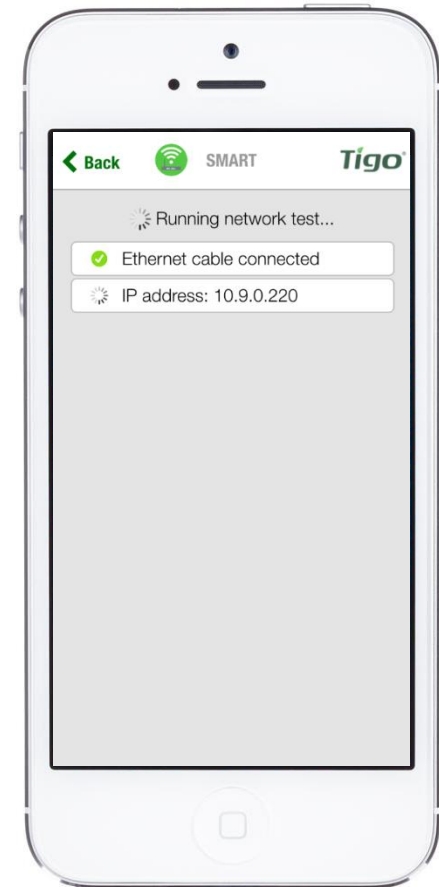

AND END UP WITH THE FOLLOWING SCREEN

Requires direct Wi-Fi connection to Cloud Connect

Press 'Continue'



INITIATE DISCOVERY

Requires direct Wi-Fi connection to Cloud Connect

- To complete the configuration for an existing system ID, select the available Cloud Connect from a map of nearby systems* or select 'Create New System' to create a new system ID

*Map requires Location enabled on Smartphone

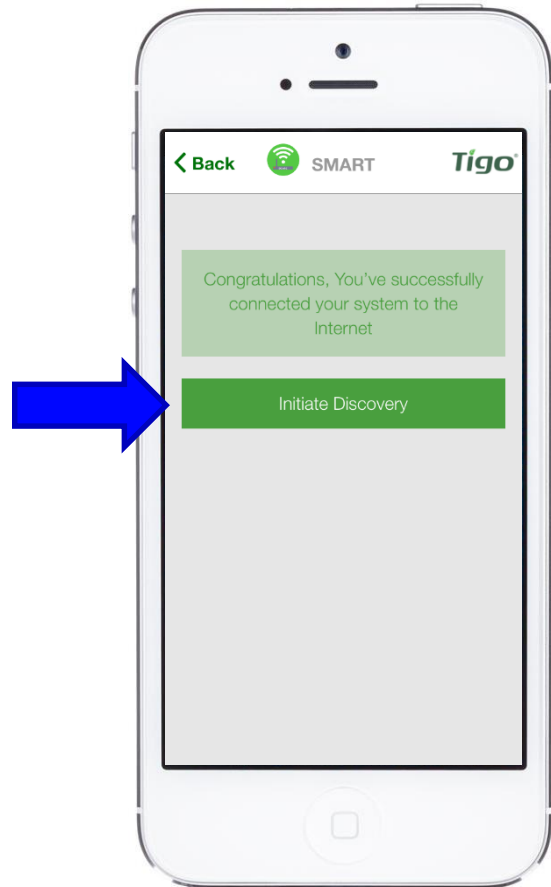

DISCOVERY OF GATEWAYS AND MODULES

Requires direct Wi-Fi connection to Cloud Connect

After the Gateways have been found, you can continue to view status while discovery is running in the background

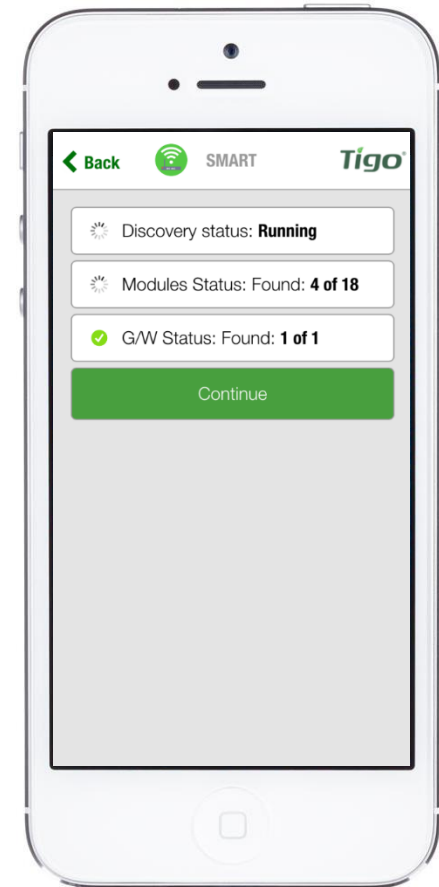

ONCE DISCOVERY IS COMPLETE

Requires direct Wi-Fi connection to Cloud Connect

You'll see a confirmation that:

- Discovery Status: Complete
- All modules have been found (e.g. 40 of 40)
- All Gateways have been found (e.g. 1 of 1)

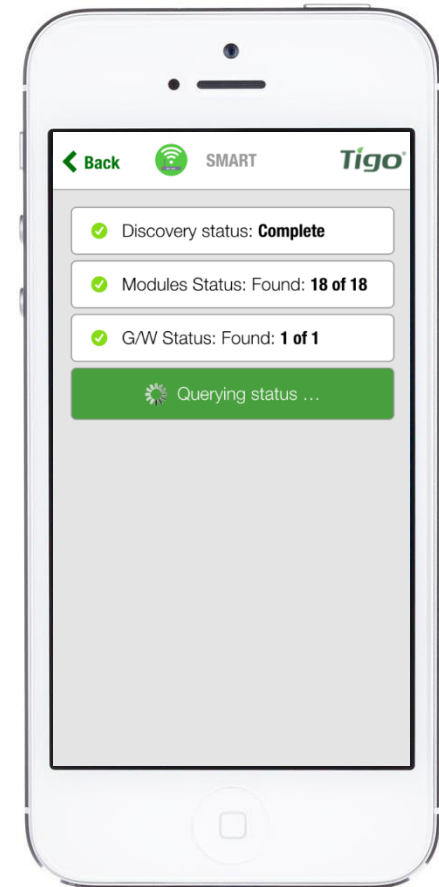

PRESSING CONTINUE GOES TO STATUS PAGE

Requires direct Wi-Fi connection to Cloud Connect

- At this point the configuration process is almost complete
- Sync now uploads all the information collected so far to the Tigo Cloud (this happens automatically as well)
- Press 'Discovery Details' to make sure discovery process has found all Smart Modules



DISCOVERY DETAILS

Requires direct Wi-Fi connection to Cloud Connect

- Once the Discovery process is complete, this screen will appear and display real time data collected from the Smart Modules, Gateways, and neighboring Smart Modules
- Expand the menus to view data

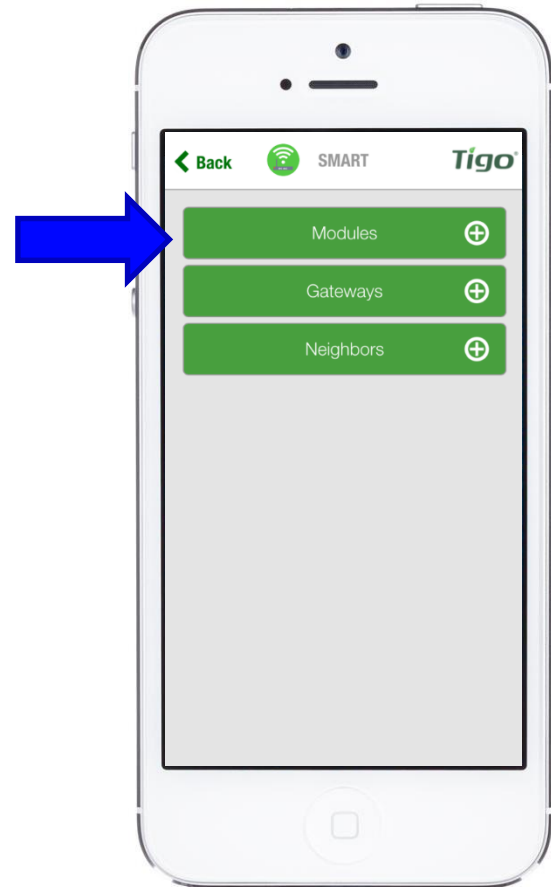

DISCOVERY DETAILS:

USE THE 'MODULES' SCREEN TO

COMPLETE COMMISSIONING

Requires direct Wi-Fi connection to Cloud Connect

Use the power (P), voltage (V), and current (I) views to make sure the smart modules are properly connected



PRESSING 'BACK' WILL RETURN TO STATUS PAGE

Requires direct Wi-Fi connection to Cloud Connect

- Press 'Continue'



AND YOU'RE DONE!

TIGO EQUIPMENT COMMISSIONING

COMPLETE

- Once discovery completed, after pressing “Continue” you’ll be prompted to the following screen
- Pressing “Done” will bring you to the “Installation” or “Monitoring” page. You may leave the app and close it at this point

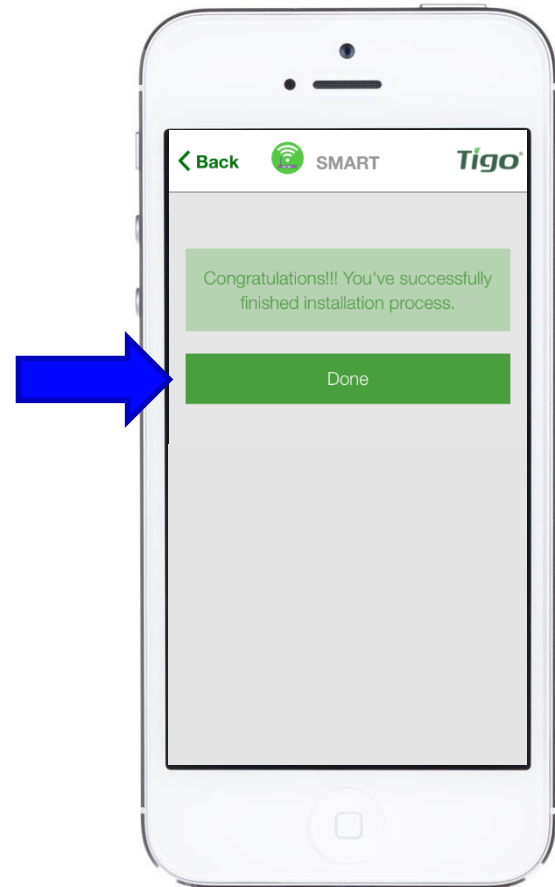
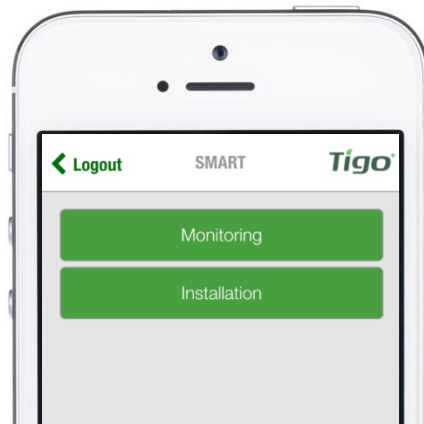

MAPPING, CONFIGURATION AND COMMISSIONING SUMMARY

- Collect all TS4 barcodes, use a [string list](#) template or any other method to make sure your barcodes are well organized
- Complete the online configuration on a PC or MAC before attempting Discovery
- Perform a Network Test, Gateway Test, and Discovery for each Cloud Connect or Cloud Connect Advanced while on site
- View test results and Discovery progress using your app
- Once Discovery is complete, the Cloud Connect or Cloud Connect Advanced will begin sending data to the Tigo cloud



7. RAPID SHUTDOWN

TS4-L, TS4-O, and TS4-S with Cloud Connect/Cloud Connect and Gateway are a solution to meet NEC 2014 690.12 Rapid Shutdown requirements, when combined with a DC disconnect at the inverter.

When Rapid Shutdown is initiated, the voltage across PV conductors will drop below 30V within 10 seconds at the module level.

Rapid Shutdown is activated by taking 2 simple actions.

To activate rapid shutdown (with most inverters order of actions doesn't matter):

1. Switch off DC disconnect as well to disconnect capacitors.
2. Switch OFF AC main to deactivate system.

In the inverter's box you'll find 2 red labels to mark the Rapid Shutdown equipment. Place one sticker next to the inverter's DC switch and the other on the AC main breaker. **Both labels must be visible!**

Only a properly installed, configured, and tested system will perform Rapid Shutdown properly.

[CLICK HERE](#) for more info about Rapid Shutdown



8. CONNECTING MODBUS DEVICES (OPTIONAL)

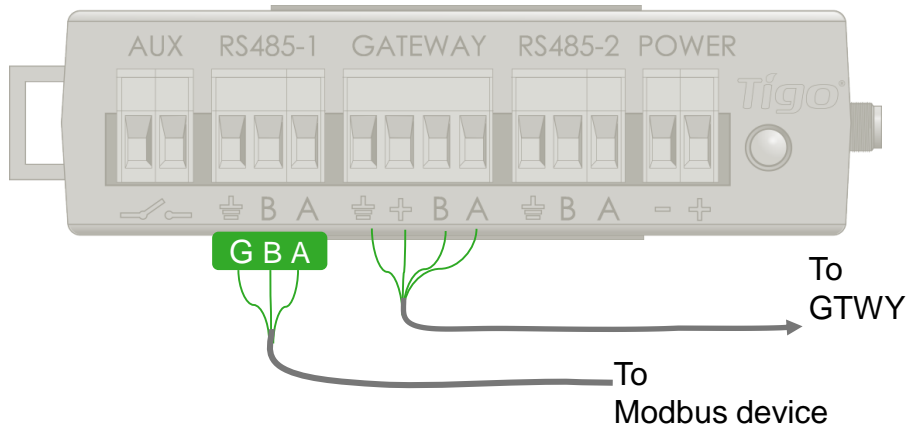
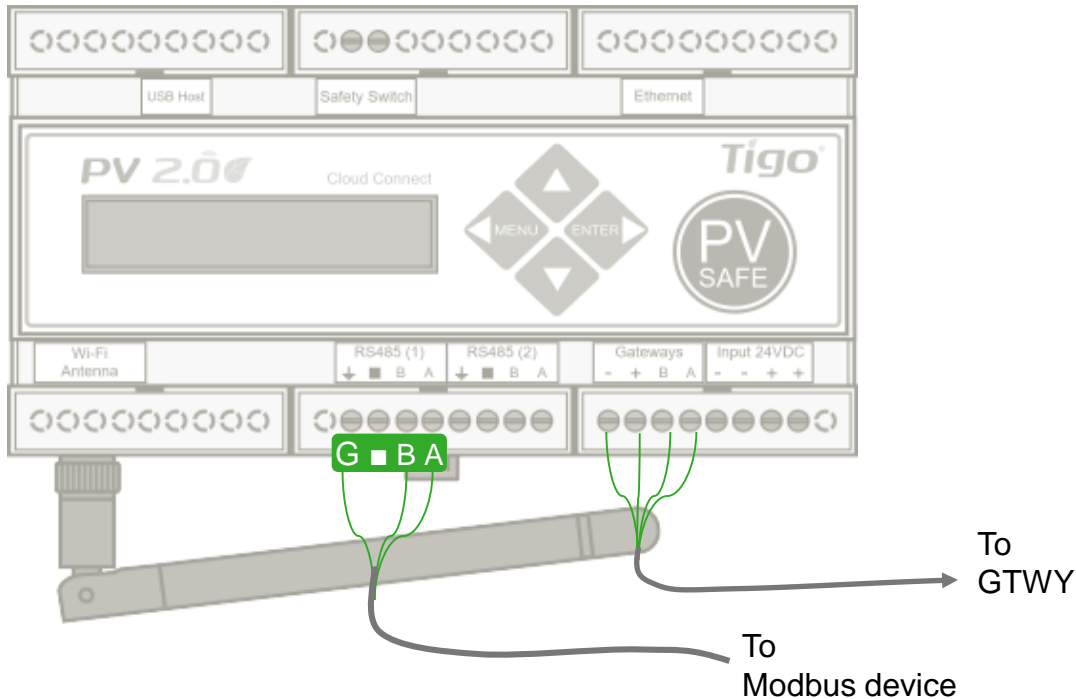

INSTALLATION:

1. Verify device settings for AC meter, inverter, etc. in its own installation manual
2. Connect devices to RS-485 port on CC or CCA (note: similar devices can be connected in series)
3. Contact Tigo Tech Support to activate a connected device

1.408.402.0802 ext. 2
00800.CALL.TIGO(2255.8446)
support@tigoenergy.com

RECOMMENDED SETTINGS:

- 9600 baud rate
- 8 bits data
- 1 stop bit
- No parity



TECHNICAL SPECIFICATIONS – SMART MODULE WITH TS4-B BASE

TS4 COVERS



DIODES
TS4-D



MONITORING
TS4-M



SAFETY
TS4-S



OPTIMIZATION
TS4-O



LONG STRINGS
TS4-L

ELECTRICAL RATINGS

INPUT					
Rated DC Input Power	375W	475W	475W	475W	475W
Maximum V_{OC} @ STC	90V	75V	75V	75V	75V
Maximum Short Circuit Current (I_{SC})	12A	12A	12A	12A	12A
Minimum V_{MP}	N/A	16V	16V	16V	16V
Max Input Voltage @ Lowest Temp	N/A	90V	90V	90V	90V
OUTPUT					
Output Power Range	0 - 375W	0 - 475W	0 - 475W	0 - 475W	0 - 475W
Output Voltage Range	0 - V_{OC}	0 - V_{OC}	0 - V_{OC}	0 - V_{OC}	0 - V_{OC}
Communication Type	N/A	802.15.4 2.4GHz	802.15.4 2.4GHz	802.15.4 2.4GHz	802.15.4 2.4GHz
Rapid Shutdown Capability (NEC 2014 690.12)	Need additional RS device	Need additional RS device	Yes	Yes	Yes
Impedance Matching Capability	No	No	No	Yes	Yes
Output Voltage Limit	No	No	No	No	Yes
Maximum System Voltage	1500V	1500V	1500V	1500V	1500V

All TS4 covers are 1500V compatible. Specify system voltage when ordering (1000V / 1500V) for appropriate cables & connectors

Rapid shutdown requires TS4-S or higher, installed with Cloud Connect and Gateway



TECHNICAL SPECIFICATIONS – RETROFIT UNIT WITH TS4-R BASE

TS4-R

ELECTRICAL RATINGS



MONITORING
TS4-R-M



SAFETY
TS4-R-S



OPTIMIZATION
TS4-R-O

INPUT @ STC			
Rated DC Input Power	475W	475W	475W
Maximum V_{OC} @ STC	75V	75V	75V
Maximum Short Circuit Current (I_{SC})	12A	12A	12A
Minimum V_{MP}	16V	16V	16V
Maximum Input Voltage @ Lowest Temperature	90V	90V	90V
OUTPUT			
Output Power Range	0 - 475W	0 - 475W	0 - 475W
Output Voltage Range	0 - V_{OC}	0 - V_{OC}	0 - V_{OC}
Communication Type	802.15.4 2.4GHz	802.15.4 2.4GHz	802.15.4 2.4GHz
Rapid Shutdown Capability (NEC 2014 690.12)	Need additional RS device	Yes	Yes
Impedance Matching Capability	No	No	Yes
Output Voltage Limit	No	No	No
Maximum System Voltage	1500V	1500V	1500V

All TS4 covers are 1500V compatible. Specify system voltage when ordering (1000V / 1500V) for appropriate cables & connectors

Rapid shutdown requires TS4-S or higher, installed with Cloud Connect and Gateway



TECHNICAL SPECIFICATIONS

MECHANICAL SPECIFICATIONS – TS4-B and TS4-R

Mechanical

Operating Temperature Range	-40°C to +75°C (-40°F to +167°F)
Storage Temperature Range	-40°C to +75°C (-40°F to +167°F)
Cooling Method	Natural Convection
Dimensions (with cover)	152.5mm x 108mm x 25.3mm
Weight (base without cover)	270g
Outdoor Rating	IP67, NEMA 3R

Cabling

Type	PV1-F, PV wire
Output Length	Standard 1.0m, other lengths on request
Cable Options	1000V rated 1500V rated
Cable Cross-Section	7.15 ± 0.25 mm (1000V) 6.4 ± 0.2mm, 7.05 ± 0.2mm (1500V)
Connectors	MC4, MC4 compatible, Amphenol, EVO2
UV Resistance	500hr with UV light between 300-400nm @65C
Maximum String Voltage	1500V UL/IEC ¹

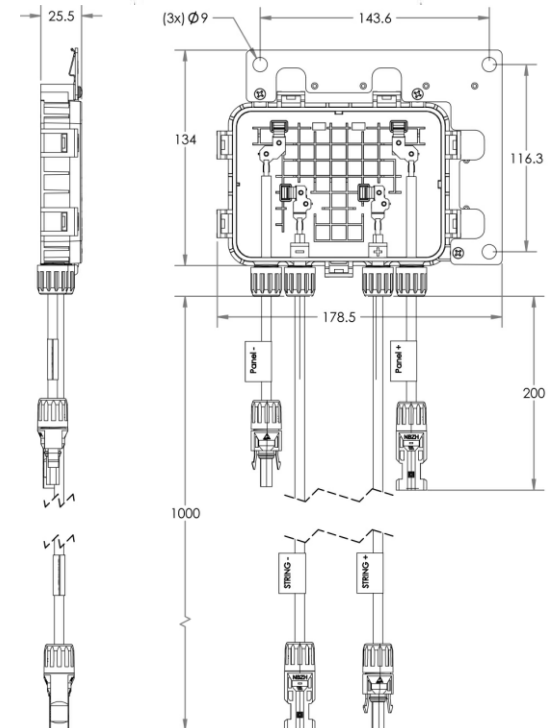
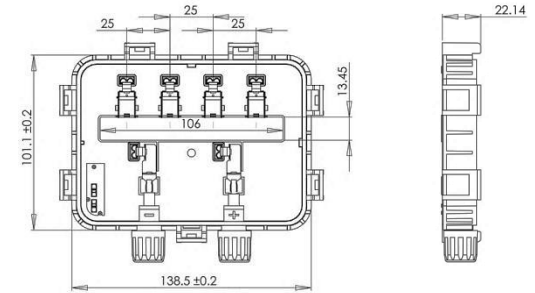

¹ All TS4 covers are 1500V compatible. Specify max system voltage when ordering modules with TS4 bases for appropriate cables & connectors.



YOU'RE GOOD TO GO!

For more details on designing and installing solutions powered by Tigo, please visit:

- [Tigo Academy](#)
- [Resource Center](#)

Or contact us at:

- Training@tigoenergy.com

GOOD LUCK!

Tigo Team

