



Off-Grid Inverter

SUNNY ISLAND 4548-US / 6048-US

Operating Manual



Legal Provisions

Copyright © 2015 SMA Solar Technology America LLC. All rights reserved.

No part of this document may be reproduced, stored in a retrieval system, or transmitted, in any form or by any means, be it electronic, mechanical, photographic, magnetic or otherwise, without the prior written permission of SMA Solar Technology America LLC.

SMA Solar Technology America LLC doesn't make representations, express or implied, with respect to this documentation or any of the equipment and/or software it may describe, including (with no limitation) any implied warranties of utility, merchantability, or fitness for any particular purpose. All such warranties are expressly disclaimed. Neither SMA Solar Technology America LLC nor its distributors or dealers shall be liable for any indirect, incidental, or consequential damages under any circumstances.

(The exclusion of implied warranties may not apply in all cases under some statutes, and thus the above exclusion may not apply.)

Specifications are subject to change without notice. Every attempt has been made to make this document complete, accurate and up-to-date. Readers are cautioned, however, that SMA Solar Technology America LLC reserves the right to make changes without notice and shall not be responsible for any damages, including indirect, incidental or consequential damages, caused by reliance on the material presented, including, but not limited to, omissions, typographical errors, arithmetical errors or listing errors in the content material.

All trademarks are recognized even if these are not marked separately. Missing designations do not mean that a product or brand is not a registered trademark.

The *Bluetooth*[®] word mark and logos are registered trademarks owned by Bluetooth SIG, Inc. and any use of such marks by SMA Solar Technology America LLC and SMA Solar Technology Canada Inc. is under license.

Modbus[®] is a registered trademark of Schneider Electric and is licensed by the Modbus Organization, Inc.

Phillips[®] and Pozidriv[®] are registered trademarks of Phillips Screw Company.

Torx[®] is a registered trademark of Acument Global Technologies, Inc.

SMA Solar Technology America LLC

3801 N. Havana Street
Denver, CO 80239 U.S.A.

Important Safety Instructions

SAVE THESE INSTRUCTIONS

This manual contains important instructions for the following products:



- Sunny Island 4548-US / 6048-US

This manual must be followed during installation and maintenance.

The product is designed and tested in accordance with international safety requirements, but as with all electrical and electronic equipment, certain precautions must be observed when installing and/or operating the product. To reduce the risk of personal injury and to ensure the safe installation and operation of the product, you must carefully read and follow all instructions, cautions and warnings in this manual.

Warnings in this Document

A warning describes a hazard to equipment or personnel. It calls attention to a procedure or practice, which, if not correctly performed or adhered to, could result in damage to or destruction of part or all of the SMA equipment and/or other equipment connected to the SMA equipment or personal injury.

Symbol	Description
 DANGER	DANGER indicates a hazardous situation which, if not avoided, will result in death or serious injury.
 WARNING	WARNING indicates a hazardous situation which, if not avoided, could result in death or serious injury.
 CAUTION	CAUTION indicates a hazardous situation which, if not avoided, could result in minor or moderate injury.
NOTICE	NOTICE is used to address practices not related to personal injury.

Other symbols in this document





In addition to the safety and hazard symbols described on the previous pages, the following symbol is also used in this manual:

Information

This symbol accompanies notes that call attention to supplementary information that you must know and use to ensure optimal operation of the system.

Markings on this Product

The following symbols are used as product markings with the following meanings.

Symbol	Description
	<p>Warning regarding dangerous voltage</p> <p>The product works with high voltages. All work on the product must only be performed as described in the documentation of the product.</p>
	<p>Electric arc hazards</p> <p>The product has large electrical potential differences between its conductors. Arc flashes can occur through air when high-voltage current flows. Do not work on the product during operation.</p>
	<p>Beware of hot surface</p> <p>The product can become hot during operation. Do not touch the product during operation.</p>
	<p>Observe the operating instructions</p> <p>Read the documentation of the product before working on it. Follow all safety precautions and instructions as described in the documentation.</p>
	<p>UL1741 is the standard applied by Underwriters Laboratories to the product to certify that it meets the requirements of the National Electrical Code®, the Canadian Electrical Code® CSA C22.1, IEEE 929 2000 and IEEE 1547.</p>

General Warnings

⚠ WARNING

All electrical installations must be made in accordance with the local and *National Electrical Code*[®] ANSI/NFPA 70 or the *Canadian Electrical Code*[®] CSA C22.1. This document does not and is not intended to replace any local, state, provincial, federal or national laws, regulations or codes applicable to the installation and use of the product, including without limitation applicable electrical safety codes. All installations must conform with the laws, regulations, codes and standards applicable in the jurisdiction of installation. SMA assumes no responsibility for the compliance or non-compliance with such laws or codes in connection with the installation of the product.

The product contains no user-serviceable parts.

For all repair and maintenance, always return the unit to an authorized SMA Service Center.

Before installing or using the product, read all of the instructions, cautions, and warnings in this manual.

Before connecting the product to the electrical utility grid, contact the local utility company. This connection must be made only by qualified personnel.

Wiring of the product must be made by qualified personnel only.

Table of Contents

1	Information on this Document	15
1.1	Validity	15
1.2	Target Group	15
1.3	Additional Information	15
1.4	Terminology	15
2	Sunny Island 4548-US / 6048-US	16
2.1	Properties	16
2.2	At a Glance	22
2.3	Scope of Delivery	23
2.4	Required Tools and Materials	25
2.5	Identifying the Sunny Island	25
3	Safety	26
3.1	Intended Use	26
3.2	Important Notes regarding Operation	27
3.3	Potential Hazards	29
4	Mounting	31
4.1	Selecting the Mounting Location	31
4.2	Mounting the Sunny Island with the Wall Mounting Bracket	33
4.2.1	Mounting the Sunny Island on a Stone Wall	34
4.2.2	Mounting the Sunny Island using Wall Studs	36
5	Opening and Closing	37
5.1	Opening the Sunny Island	37
5.2	Closing the Sunny Island	38
6	Electrical Connection	39
6.1	Grounding	41
6.2	DC Connection	43
6.2.1	Safety Precautions/Conditions	43
6.2.2	Cable Dimensioning	45
6.2.3	Cable Protection	46

- 6.2.4 Connecting the Sunny Island on the DC Side 46
 - 6.3 AC Connection 48
 - 6.3.1 Cable Protection 48
 - 6.3.2 AC1 (Loads/Sunny Boys) 48
 - 6.3.3 AC2 (Generator/Grid) 50
 - 6.4 Additional Connections 52
 - 6.4.1 Inserting the Data Cables. 52
 - 6.4.2 Connecting the Data Cable of the Lithium-Ion Batteries. 53
 - 6.4.3 Battery Temperature Sensor. 53
 - 6.4.4 Battery Current Sensor. 54
 - 6.4.5 Communication for Multi-Device Connection. 56
 - 6.4.6 Multifunction Relay 1 and 2. 58
 - 6.4.7 BatVtgOut Power Supply 61
 - 6.4.8 DigIn Digital Input 61
 - 6.5 Interface for External Communication 62
 - 6.5.1 Connection of the Interface for External Communication. 62
- 7 Control Elements. 66**
 - 7.1 Display Messages 67
 - 7.2 DC Circuit Breaker. 68
 - 7.3 Buttons. 68
 - 7.4 Meaning of the Light-Emitting Diodes (LED). 68
 - 7.5 SD Memory Card 68
- 8 Commissioning 69**
 - 8.1 Requirements 69
 - 8.2 Starting the Quick Configuration Guide (QCG) 69
 - 8.3 Commissioning the battery current sensor 73
- 9 Switching On and Off 75**
 - 9.1 Switching On. 75
 - 9.2 Stopping the Sunny Island (Standby) 76
 - 9.3 Switching Off. 76
 - 9.4 Disconnecting the Device from Voltage Sources 76

9.5	Recommissioning After Automatic Shutdown	77
10	Operation	79
10.1	Menu Structure	80
10.2	Changing Parameters	83
10.3	Direct Access - Direct Access to the Parameters	84
10.4	Compact Meters	84
10.5	Entering the Installer Password	88
10.6	Display Messages (Overview)	89
10.7	Parameter Display	92
10.8	Display of Events	93
10.9	Display of Warnings and Failures	93
11	Data Storage on SD Memory Card	94
11.1	Inserting the SD Memory Card	96
11.2	Removing the SD Memory Card	97
11.3	Saving and Loading Parameters	98
11.4	Writing Log Data	98
11.5	Status Messages	99
11.6	Firmware Update	100
12	Additional Functions	103
12.1	Load Shedding	103
12.2	Sleep Mode	105
12.3	Time-Controlled Operation	105
12.4	Overload and Short-Circuit Behavior	105
12.5	Mixed Operation with Sunny Island Inverters of Different Power	105
12.6	Device Faults and Autostart	106
12.7	Automatic Frequency Synchronization	106
12.8	Time-Controlled Standby	106
12.9	Behavior in the Event of a Failure in a Three-Phase System	107
13	Battery Management	108
13.1	Battery Type and Minimum Battery Capacity	108

13.2	Battery Temperature	109
13.3	Start Options	109
13.4	State of Charge (SOC) and State of Health (SOH)	109
13.5	Charge Control	111
13.5.1	Boost Charge	113
13.5.2	Full Charge	113
13.5.3	Equalization Charge	114
13.5.4	Manual Equalization Charge	114
13.5.5	Silent Mode	114
13.6	Battery-Preservation Mode	115
13.7	Battery Diagnosis	116
13.8	Battery Lead Resistance	117
14	Connecting External Sources	118
14.1	Generator	118
14.1.1	Parallel Connection	118
14.1.2	Generator Start Options	120
14.1.3	Generator Operation	122
14.1.4	Manual Generator Operation	122
14.1.5	Automatic Generator Operation	123
14.1.6	Limits and Power Control	126
14.1.7	Run Times	127
14.1.8	Operation Together with PV Inverters and Wind Power Inverters ..	128
14.1.9	Stopping the Generator	129
14.1.10	Stopping the Sunny Island	129
14.1.11	Disturbances	129
14.2	Utility grid	130
14.2.1	Limits of the Voltage Range and Frequency Range	130
14.2.2	Starting the Sunny Island	131
14.2.3	Operation in Case of a Grid Failure in a Battery-Backup Grid ..	131
14.2.4	Battery-Backup Operation and Anti-Islanding	131
14.2.5	Grid Reconnection	132
14.2.6	Grid Operation	132

14.2.7 Grid Failure	135
14.2.8 Disturbances	135
14.2.9 Limitations and Power Control	136
14.2.10 Operation Together with PV Inverters and Wind Power Inverters	136
14.3 Generator and Utility Grid	137
15 Relays	140
16 Multicluster Operation	143
16.1 Communication between the Sunny Island Inverters	143
16.2 Commissioning the Multicluster System	145
16.3 Switching a Multicluster System On and Off	146
16.3.1 Switching On/Starting	146
16.3.2 Stopping and Switching Off	146
16.3.3 Load Shedding in a Multicluster System	147
16.4 Generator Operation	147
16.5 Behavior with Different States of Charge	147
16.6 Testing Multicluster Communication	148
16.7 Automatic Frequency Synchronization	148
16.8 Firmware Update	148
16.9 Error Handling in a Multicluster System	149
16.10 Grid Operation	149
16.11 Generator Emergency Operation	149
17 PV Inverters	150
17.1 Connection to the Stand-Alone Grid (Protected Load Switch)	150
17.2 Setting the Off-Grid Parameters	151
17.3 Configuration of the PV Inverters with a Communication Products	151
17.4 Parameter Settings of the PV Inverters	152
17.4.1 Configuration of the PV Inverters in Battery-Backup Systems	152
17.4.2 Configuration of PV Inverters in Off-Grid Systems	153
17.5 Frequency-Shift Power Control (FSPC)	154
18 Maintenance and Care	156
18.1 Enclosure	156

- 18.2 Cleaning the Fans 156
- 18.3 Display..... 156
- 18.4 Function 156
- 18.5 Battery 157
- 18.6 Disposal..... 157
- 19 Parameter Lists 158**
- 19.1 Display Values 158
 - 19.1.1 Inverter Meters (110#) 158
 - 19.1.2 Battery Meters (120#)..... 161
 - 19.1.3 External Meters (130#)..... 162
 - 19.1.4 Charge Controller (140#)(not UL-certified)..... 165
- 19.2 Adjustable Parameters 167
 - 19.2.1 Inverter Settings (210#)..... 167
 - 19.2.2 Battery Settings (220#) 168
 - 19.2.3 External Settings (230#) 172
 - 19.2.4 Relay Settings (240#) 181
 - 19.2.5 System Settings (250#) 191
 - 19.2.6 Password Setting (280#)..... 193
- 19.3 Diagnosis (300#) 193
 - 19.3.1 Inverter Diagnosis (310#) 193
 - 19.3.2 Battery Diagnosis (320#) 196
 - 19.3.3 External Diagnosis (330#)..... 200
- 19.4 Events, Warnings and Errors (History)..... 200
 - 19.4.1 Failure/Event (400#)..... 200
- 19.5 Functions in Operation..... 200
 - 19.5.1 Operation (500#) 200
- 19.6 Direct Access to the Parameters..... 203
 - 19.6.1 Direct Access (600#)..... 203
- 20 Troubleshooting 204**
- 20.1 Error Acknowledgement 204
- 20.2 Autostart Handling..... 204
- 20.3 Master-Slave Handling 204

20.4	Handling of Pending Errors during the Booting Procedure	205
20.5	Display of Failures and Events	205
20.6	Events	205
20.6.1	Category INV	205
20.6.2	Category BAT	206
20.6.3	Category GEN	206
20.6.4	Category GRD	207
20.6.5	Category REL	207
20.6.6	Category SYS	208
20.7	Failure Categories	209
20.8	Warnings and Error Messages	209
20.8.1	Category INV	210
20.8.2	Category BAT	211
20.8.3	Category EXT	211
20.8.4	Category GEN	214
20.8.5	Category GRD	214
20.8.6	Category RLY	214
20.8.7	Category SYS	214
20.8.8	AUX Category	217
20.8.9	Category SYS	218
20.9	Troubleshooting	219
20.10	Procedure during Emergency Charge Mode	223
21	Accessory	226
22	Technical Data	227
22.1	Sunny Island 4548-US	227
22.2	Sunny Island 6048-US	230
23	Glossary	233
24	Compliance Information	241
25	Contact	242

1 Information on this Document

1.1 Validity

This document is valid for the following battery inverters as of firmware version 7.3:

- Sunny Island 4548-US (SI 4548-US-10)
- Sunny Island 6048-US (SI 6048-US-10)

1.2 Target Group

This document is for trained electrically qualified persons. A trained electrically qualified person has received sufficient training and has knowledge of the design and function of the device and has demonstrable practical experience of mounting, connecting and commissioning of the device. An electrically qualified person is trained to deal with the dangers and hazards involved in installing electrical systems.

1.3 Additional Information

You will find further information on special topics such as selecting and using PV inverters in off-grid systems in the download area at www.SMA-America.com.

1.4 Terminology

In this document, SMA Solar Technology America LLC is referred to in the following as SMA.

The syntax specified here for menus and parameters applies throughout the entire document.

Menu: Menu number, hash and menu name (150# Compact Meters)

Parameter: Menu number, dot, parameter number and parameter name (150.01 GdRmgTm)

2 Sunny Island 4548-US / 6048-US

2.1 Properties

The Sunny Island is a bidirectional inverter (battery inverter and battery charger) for off-grid systems. The Sunny Island supplies loads on the stand-alone grid side and charges the batteries with the energy from grid-feeding units connected on the AC side.

The comfortable support of AC and DC coupling, as well as the expandability of the systems formed with the Sunny Island guarantee highest flexibility. In addition, innovative technology allows the Sunny Island to achieve a maximum efficiency of more than 95%. Optimized for partial load operation, it impresses with low open-circuit and standby consumption. Due to the high overload capacity and the integrated output management, there is no need to oversize the Sunny Island.

The operation of up to three devices in a single-phase parallel system, of three devices in a three-phase system or of up to four devices in a double split-phase system enables the Sunny Island to establish off-grid power supply systems with a power of between 2 kW to 24 kW. In Multicluster systems, powers of up to as much as 100 kW are possible. Thanks to its sophisticated generator management, the Sunny Island can control connected diesel generators in a particularly low-stress and fuel-saving manner. The utility grid can also be integrated. The Sunny Island can also deactivate loads automatically if the battery does not provide sufficient electrical energy.

The critical component of the off-grid system, the battery, is diligently monitored and optimally utilized. For lead-acid batteries, the intelligent battery management of the Sunny Island precisely records the state of charge of the battery. This makes an improved utilization of the battery capacity possible, which also means that smaller and thus more cost-effective batteries can be used without affecting performance. The Sunny Island also offers an interface to integrate the external battery management of lithium-ion batteries.

In order to prevent premature aging caused by incorrect charging and frequent deep discharge, the Sunny Island has an intelligent charge control and reliable deep-discharge protection. Thanks to these functions, the battery life can be greatly extended in comparison with simpler devices.

Despite its complex functioning, the Sunny Island is easy to configure. All the settings required for operation can be quickly and easily configured in a few steps using the Quick Configuration Guide (QCG). By employing the concept of central operation referred to as "Single Point of Operation", the system/cluster parameters are only set on the master device, and all other devices automatically adopt the configuration. The easy-to-understand menu navigation allows quick access to all important data, even while the system is running. An SD memory card offers an easy system control and facilitates servicing.



Saving data and events

Always use the SD memory card to save data and events. In case of a failure SMA can thus help you quickly.

The Sunny Island monitors the set voltage and frequency limits on the utility grid and generator. If these limits are not observed, it disconnects from the external source without interruption and changes to stand-alone mode.

The Sunny Island also has an integrated anti-islanding feature which prevents islanding on the utility grid. If this process is triggered, the system also completely changes to stand-alone mode without interruption.

The Sunny Island can be integrated into different system constellations. The following graphics show the devices of a Sunny Island system and the different wiring options (single-phase / single-phase parallel, split-phase, double-split-phase and three-phase).

Devices of a Sunny Island System:

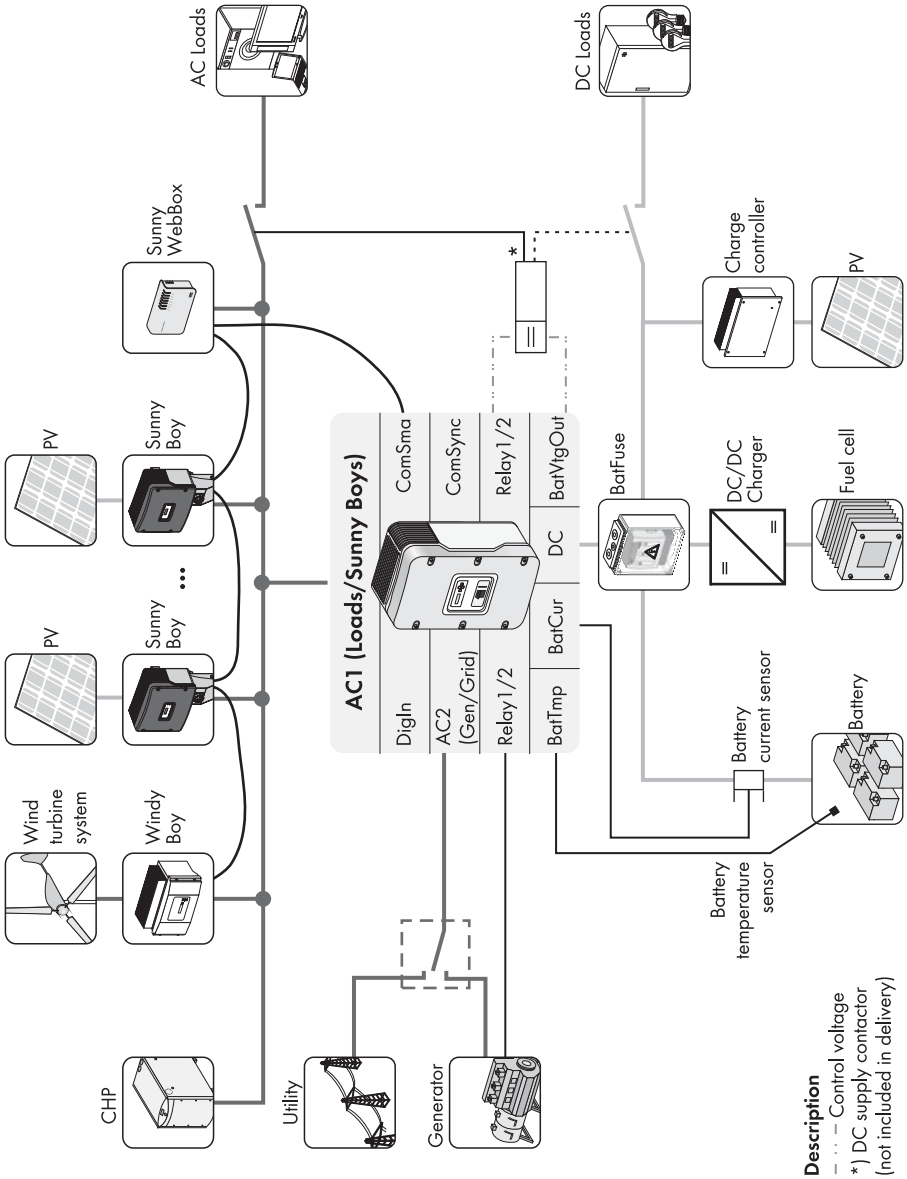

Single-Phase System, 120 Vac, up to 6 kW:

- 4.5 kW with SI 4548-US-10
- 6 kW with SI 6048-US-10

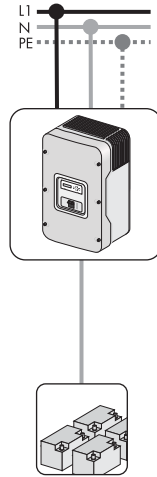

Single-Phase Parallel System, 120 Vac, up to 18 kW:

Maximum 3 Sunny Island of types SI 4548-US-10 / 6048-US-10.*

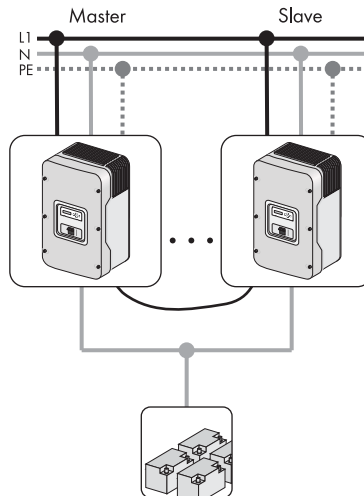

* The types SI 4548-US-10 / 6048-US-10 can be arbitrarily combined, also with older devices of type SI 5048U.

Split-Phase System, 240 Vac, up to 12 kW

2 Sunny Island of types SI 4548-US-10 / 6048-US-10.*

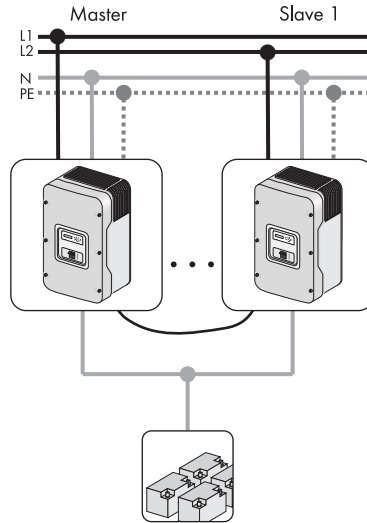

Three-Phase System, 120/208 Vac, up to 18 kW

3 Sunny Island of types SI 4548-US-10 / 6048-US-10.*

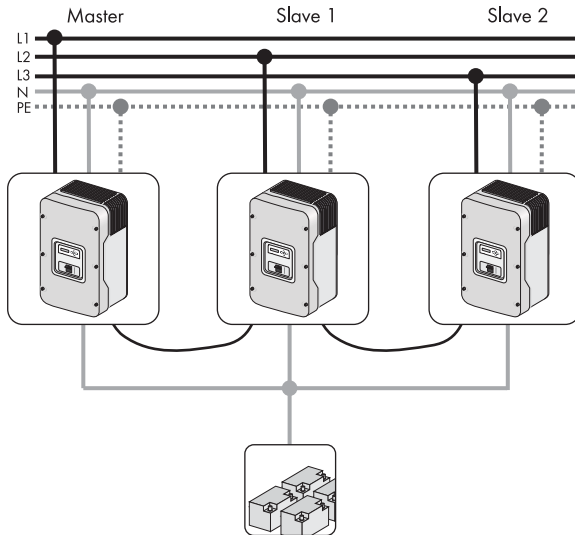

* The types SI 4548-US-10 / 6048-US-10 can be arbitrarily combined, also with older devices of type SI 5048U.

Double Split-Phase System, 240 Vac, up to 24 kW

4 Sunny Island of types SI 4548-US-10 / 6048-US-10. Only Sunny Island inverters of the same type must be used on one line conductor. L1 and L2 may be installed with different types (e.g.: L1 with 2 x SI 4548-US-10 und L2 with 2 x SI 6048-US-10).*

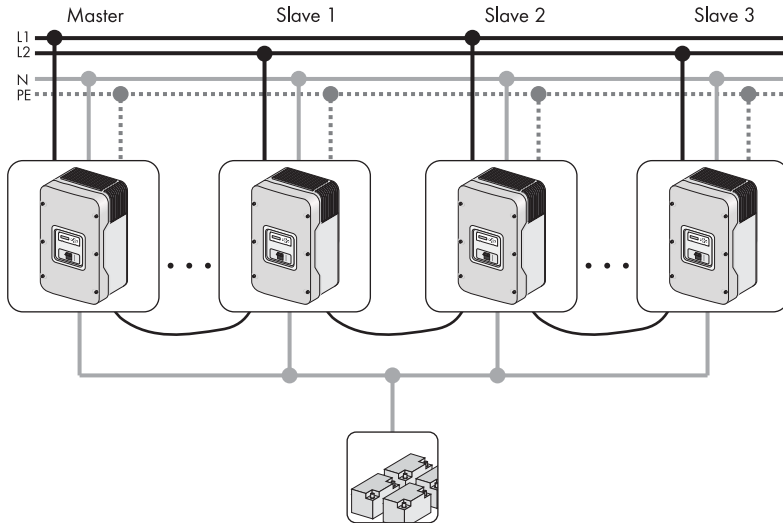

SMA multicluster technology

You will find all other information on SMA multicluster technology for up to twelve Sunny Island inverters and up to 100 kW power in the installation manual of the Multicluster Box.

* The types SI 4548-US-10 / 6048-US-10 can be arbitrarily combined, also with older devices of type SI 5048U.

2.2 At a Glance

The following figure provides an overview of all control elements and connections of the Sunny Island:

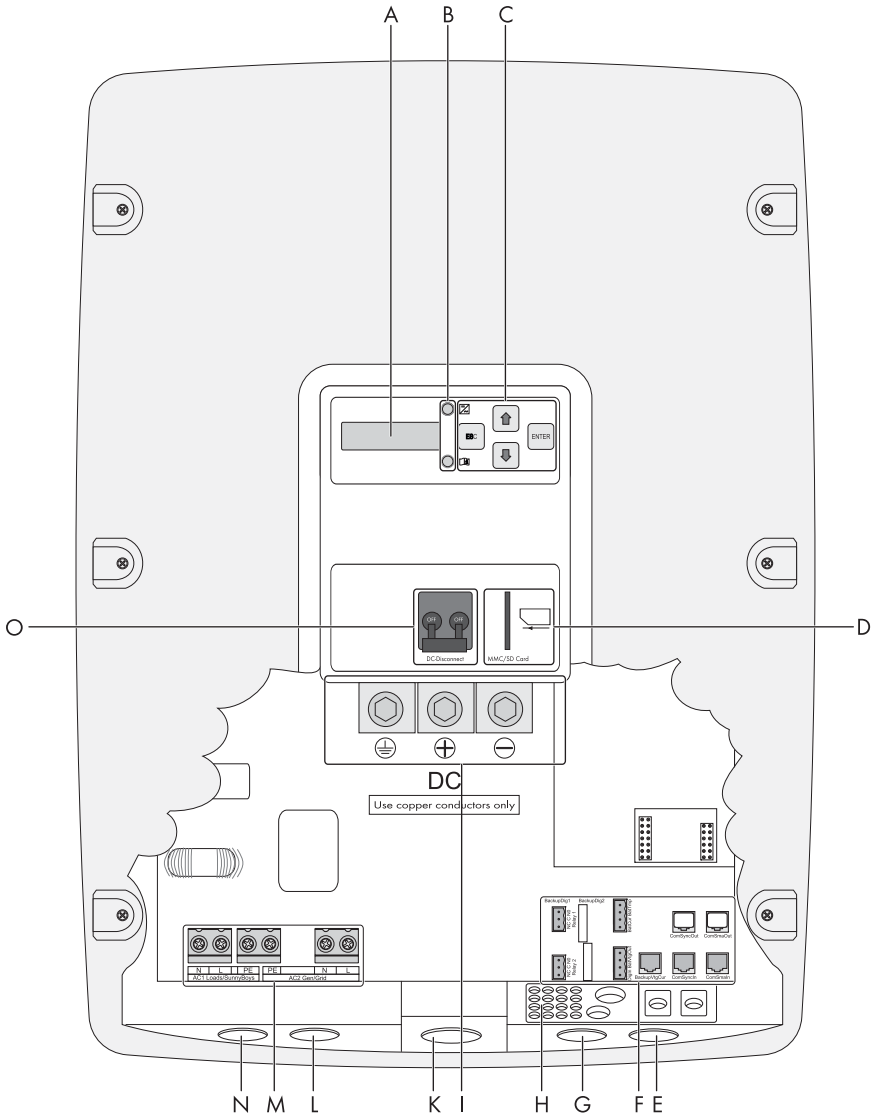

Position	Description
A	Display

Position	Description
B	LEDs showing device operation
C	Control buttons
D	Slot for the SD memory card
E	Opening for the additional connections area (insertion of the cables via conduits)
F	Connection area for additional connections
G	Opening for the additional connections area (insertion of the cables via conduits)
H	Rubber enclosure opening for the area of additional connections (inserting cables without conduits)
I	DC connection area
K	Opening for the DC connection area (insertion of DC+, DC – and the grounding conductor)
L	Opening for AC2 terminal (insertion of the conductors L, N and grounding conductor)
M	AC connection area
N	Opening for AC1 terminal (insertion of the conductors L, N and grounding conductor)
O	DC circuit breaker

2.3 Scope of Delivery

Check that the delivery is complete. Check the packaging and the Sunny Island for externally visible damage.

Contact your supplier in case of damage to the packaging. Please contact your distributor if you find any damage to the Sunny Island or if the delivery is incomplete.



Keeping the packaging

Keep the packaging in case you need to return the inverter or its accessories.

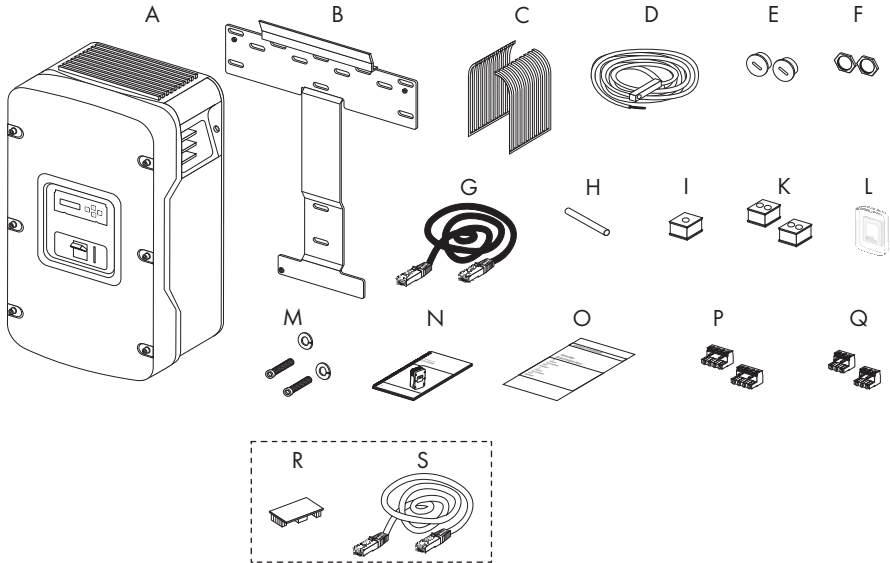

Position	Quantity	Designation
A	1	Sunny Island
B	1	Wall mounting bracket
C	2	Ventilation grid
D	1	Battery temperature sensor
E	2	Filler plug
F	2	Counter nut for filler plug
G	1	RJ45 cable, black
H	1	Silicone tube
I	1	Rubber plugs for feed-through of one cable
K	2	Rubber plugs for feed-through of 2 cables
L	1	SD memory card
M	2	M6x10 hexagon socket screw and split lock washer for connecting the Sunny Island to the wall mounting bracket
N	1	Operating manual
O	1	Test report
P	2	4-pole terminal for connecting the battery temperature sensor and battery current sensor
Q	2	3-pole terminal for connecting the relays 1 and 2

Position	Quantity	Designation
R	1	RS485 Piggy-Back (optional)
S	1	RJ45 cable, white (optional)

2.4 Required Tools and Materials

The following tools and materials are required in order to mount and install the Sunny Island 4548-US / 6048-US:

Tools (not included in scope of delivery)

Cable knife

Combination pliers

Crimping tool for bootlace ferrules (suitable for wire sizes up to 3/0 AWG)

Diagonal cutting pliers

Drill

Drill bit (e.g. for masonry or wood), fastener $\frac{3}{8}$ in or \varnothing 10 mm

Flat-blade screwdriver 2.5 mm

Flat-blade screwdriver SZS 1.0 x 6.5

Allen key, 3 mm to 8 mm

Multimeter

Open-end/box wrenches or socket wrenches in the sizes 10/19/24/30

Cross-head screwdriver, PH1 and PH2

Spirit level

Torque wrench 4 ft-lb to 21 ft-lb (6 Nm to 28 Nm) with hexagon socket screwdriver bit in the sizes 5 mm and 10 mm

Torque wrench 5 in-lb to 22 in-lb (0.56 Nm to 2.5 Nm) with flat-blade screwdriver bit in the sizes 2.5 mm and flat-blade screwdriver SZS 1.0 x 6.5

Insulation stripping tool

Material (not included in scope of delivery)

Cable tie

Heat-shrink tubing

Hexagon screws, 8 mm x 60 mm

Washers

Screw anchor for the wall mounting bracket (e.g. SX 10)

Bootlace ferrules appropriate for the selected cable (see Section 6 "Electrical Connection", page 39)

2.5 Identifying the Sunny Island

Identify the Sunny Island by the serial number (Serial No.) and the device type (Type) on the type label. The type label is located on the right-hand side of the enclosure. You will require the information on the type label to use the product safely and when seeking customer support from the SMA Service Line.

3 Safety

3.1 Intended Use

The Sunny Island is a bidirectional inverter (battery inverter and battery charger) for off-grid systems. The Sunny Island supplies loads on the stand-alone grid side and charges the batteries with the energy from grid-feeding units connected on the AC side.

The Sunny Island is designed for indoor use only and may only be used as stationary equipment.

The Sunny Island is not suitable for supplying life-sustaining medical devices. A power outage must not lead to personal injury.

AC sources (such as PV inverters) can be used in off-grid systems for energy supply. Too much power from the AC sources in the stand-alone grid can lead to system failures. The maximum output power of the AC sources must be observed in off-grid systems (see Section 22 "Technical Data", page 227). The powers of the individual Sunny Island inverters are added to yield the total maximum power.

The Sunny Island uses batteries for the storage of energy. The nominal voltage of the battery must correspond to the input voltage on the DC connection. The battery room must be ventilated in accordance with the requirements of the battery manufacturer and with the locally applicable standards and directives (see documentation of the battery manufacturer). If connecting a lithium-ion battery, the following must be observed:

- The lithium-ion battery must comply with the locally applicable standards and directives and be intrinsically safe.
- Ensure that the lithium-ion batteries are approved for use with the Sunny Island. The list of lithium-ion batteries approved by SMA for the Sunny Island is updated regularly (see the Technical Information "List of Approved Lithium-Ion Batteries" at www.SMA-America.com).
- If no lithium-ion batteries approved for the Sunny Island can be used, use lead-acid batteries.
- The lithium-ion batteries must be able to supply enough current at maximum output power of the Sunny Island (see Section 22 "Technical Data", page 227).

In off-grid systems or battery-backup systems with lead-acid batteries only, a maximum of four Sunny Island Charger charge controllers can be connected per cluster. In off-grid systems or battery-backup systems with lithium-ion batteries, only charge controllers approved by the manufacturer of the lithium-ion batteries must be used. A battery current sensor must be installed in off-grid systems or battery-backup systems with lithium-ion batteries and external charge controllers. The Sunny Island is not suitable for establishing a DC distribution grid.

The battery management must record the DC current when charging and discharging the battery.

The Sunny Island can control various devices in the system (e.g. load-shedding contactors) via two multifunction relays. The multifunction relays are not suitable for controlling functions which may endanger persons in the event of a malfunction of the multifunction relays, e.g. if there is insufficient redundancy in the ventilation of the battery room.

Use this product only in accordance with the information provided in the enclosed documentation and with the locally applicable standards and directives. Any other application may cause personal injury or property damage.

Alterations to the product, e.g. modifications or conversions, are permitted only with the express written permission of SMA. Unauthorized alterations will void guarantee and warranty claims and usually void the operation permit. SMA shall not be held liable for any damage caused by such changes.

Any use of the product other than that described in the Intended Use section does not qualify as appropriate.

The enclosed documentation is an integral part of this product. Keep the documentation in a convenient place for future reference and observe all instructions contained therein.

The type label must remain permanently attached to the product.

3.2 Important Notes regarding Operation

Observe all operating and safety information in this document. If these instructions are ignored, a significant danger of injury or death arises and damage to the device, system or plant may also result. Carefully read the safety precautions before installing and commissioning the device. Store the manual at an easily accessible location.

⚠ DANGER

Danger to life due to high voltages in the Sunny Island

Death or serious injury possible due to electric shock.

- All work on the Sunny Island must only be carried out by electrically qualified persons.
- All work on the Sunny Island must only be carried out in accordance with this document.
- All safety precautions listed here must be observed.

⚠ WARNING

Danger to life from electric shock due to damaged Sunny Island

Operating a damaged Sunny Island can lead to hazardous situations that can result in death or serious injuries due to electric shock.

- Only operate the Sunny Island when it is technically faultless and in an operationally safe state.
- Regularly check the Sunny Island for visible damage.
- Make sure that all external safety equipment is freely accessible at all times.
- Make sure that all safety equipment is in good working order.

⚠ WARNING**Risk of crushing injuries due to movable generator parts**

Moving parts in the generator can crush or sever body parts. A generator can be started automatically by the Sunny Island.

- Only operate the generator with the safety equipment.
- Install, maintain, and operate the generator according to the manufacturer's specifications.

⚠ WARNING**Danger to life due to incompatible lithium-ion battery**

An incompatible lithium-ion battery can lead to a fire or an explosion. Use of incompatible lithium-ion batteries can also make the user's battery management system unsafe, and void manufacturers' warranties. To avoid fire or explosion, we strongly recommend doing the following:

- Verify that the battery complies with locally applicable standards and directives, and is intrinsically safe.
- Verify that the particular lithium-ion battery type is approved for use with the SMA Sunny Island inverter (please see "List of Approved Lithium-Ion Batteries" under the Technical Information tab at www.SMA-America.com).
- If manufacturer approved Sunny Island lithium-ion batteries are not available, you may use lead acid batteries.

NOTICE**Destruction of the Sunny Island due to parallel connection of Sunny Island inverters which are set to different grid voltages**

- Do not connect a Sunny Island in parallel if its line voltage is set to different values.

NOTICE**Batteries may be destroyed due to deep discharge**

The self-consumption of the Sunny Island discharges the battery. In standby mode, this load is about 4 W and about 25 W in no-load operation.

- If you install the Sunny Island and do not wish to use it immediately, switch the Sunny Island off (**see Section 9.3 "Switching Off", page 76**).
- If you want to decommission the Sunny Island for a long period, switch the Sunny Island off (**see Section 9.3 "Switching Off", page 76**).

**Connection requirements**

Be sure to observe all valid regional standards and directives.

i **Installation altitude**

The Sunny Island has been designed for use at altitudes of up to 9,840 ft (3,000 m) above MSL. Please contact SMA before using the device at altitudes above 9,840 ft (3,000 m).

A performance loss of 0.5% per 330 ft (100 m) is to be expected starting at an altitude of 6,560 ft (2,000 m) above MSL.

3.3 Potential Hazards

⚠ DANGER**Electric shock from touching live components**

Death or serious injuries. In order to ensure complete protection against contact, comply with the following observing this document:

- Ensure that the Sunny Island is correctly mounted.
- Ensure that the Sunny Island is properly grounded.
- Ensure that all connections are correctly made.
- Ensure that the enclosure lid is firmly closed.

⚠ DANGER**Danger to life due to high voltages in the stand-alone grid**

Death or serious injury possible due to electric shock. The Sunny Island can start on its own.

- Before working on the stand-alone grid, switch off and disconnect all AC and DC power sources.
- Ensure that the system cannot be reconnected.
- Open the enclosure lid of the Sunny Island and ensure that no voltage is present.
- Ground and short-circuit the AC cables outside the Sunny Island inverter.
- Cover or isolate any adjacent live components.

⚠ DANGER**Danger to life if the Sunny Island is used to supply energy to life-sustaining medical devices**

The Sunny Island was not developed to power life-sustaining medical devices.

- Do not use the Sunny Island in systems in which a power outage might result in personal injury.

NOTICE**Destruction of the Sunny Island if installed in improper locations**

The Sunny Island is only suited for indoor installation and corresponds to degree of protection NEMA 1 (IP30, or IP40 with inserted SD memory card).

- Do not expose the Sunny Island to moisture, rain or direct solar irradiation.

4 Mounting

4.1 Selecting the Mounting Location

⚠ DANGER

Danger to life if installed in improper locations

Death or serious burns. Despite careful construction, electrical devices can cause fires.

- Do not mount the Sunny Island on flammable construction materials.
- Do not mount the Sunny Island near highly flammable materials.
- Do not mount the Sunny Island in potentially explosive areas.

⚠ CAUTION

Risk of injury through contact with hot enclosure parts during operation

Burns to the body.

- Mount the inverter in such a way that the enclosure cannot be touched inadvertently.

⚠ CAUTION

Risk of injury due to the Sunny Island falling during transport or mounting

Physical injury (fractures or crushing) and damage to the Sunny Island.

- Take the weight of the Sunny Island of 139 lb (63 kg) into account.
- Use the recessed grips or steel bars for transporting and mounting.



Overheating of the Sunny Island due to insufficient clearance to other Sunny Island inverters in areas with high ambient temperatures

If several inverters have been installed in areas with high ambient temperatures, the independent cooling of individual inverters needs to be guaranteed.

If necessary, increase the clearances between the individual inverters and make sure there is enough fresh-air supply to ensure optimum operation of the inverters.

The Sunny Island switches itself off automatically in the event of overtemperature.

Observe the following conditions during mounting:

- The mounting location and method must be suitable for the weight and dimensions of the Sunny Island.
- Mount on a solid support surface.
- The mounting location must be accessible at all times.
- The ambient temperature must be between -13°F (-25°C) and $+140^{\circ}\text{F}$ ($+60^{\circ}\text{C}$).
- Do not expose the Sunny Island to direct solar irradiation, so as to avoid power reduction due to excessive heating.

- Mount the Sunny Island in such a way that the display is at eye level in order to allow the operating state to be read at all times.
- Mount vertically or tilted backwards by max. 45°.
- Never mount the device with a forward tilt.
- Do not mount in a horizontal position.
- The connection area must not point upwards.
- The room air can have a humidity of up to 100%, but this must not be condensing.

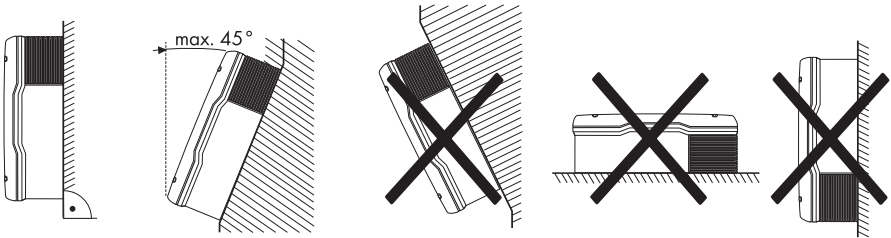

- In a living area, do not mount the unit on plasterboard walls, etc. in order to avoid audible vibrations.

The Sunny Island can make noises when in use which can be considered a nuisance when installed in a living area.

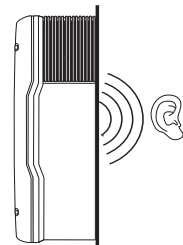

- Maintain the minimum distances to walls, other devices and objects as represented in the illustration.

In order to maintain sufficient ventilation, when installing the device a minimum clearance of 12 in (30 cm) at the sides and top must be maintained. Operation and reading are made easier by installing the Sunny Island with its display at eye level and by keeping a distance of 20 in (50 cm) from the front.

- All cables are routed to the outside through the underside of the enclosure. Therefore a minimum clearance of 20 in (50 cm) must be observed here.

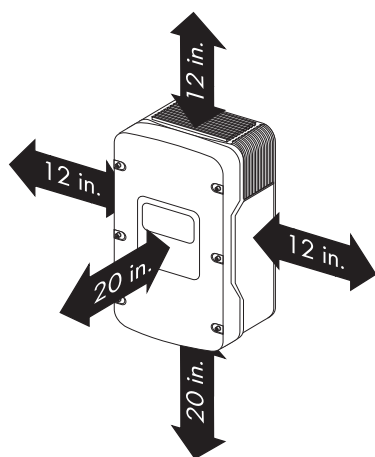

4.2 Mounting the Sunny Island with the Wall Mounting Bracket

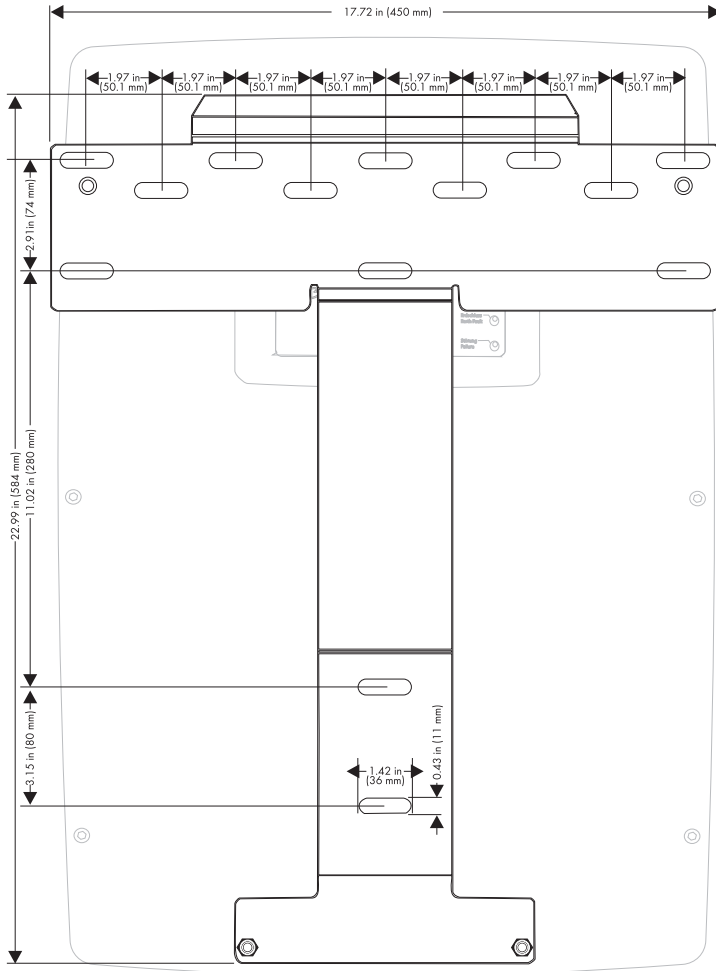

4.2.1 Mounting the Sunny Island on a Stone Wall

⚠ CAUTION

Risk of injury due to the Sunny Island falling

Physical injury (fractures or crushing) and damage to the Sunny Island.

- Ensure that the wall can carry the weight of the Sunny Island.
- If mounting onto a wooden wall with studs, ensure that the wall mounting bracket is firmly connected with all studs.

1. Place the wall mounting bracket against a suitable wall for mounting and align using a level. Mark the position of the drill holes using the wall mounting bracket. When doing this, use at least one hole on the left side and one hole on the right side of the wall mounting bracket.
2. Check the mounting location for current-carrying cables. If there are current-carrying cables at the mounting location, select a different mounting location.
3. Drill holes on the markings for them.
4. Secure the wall mounting bracket to the wall using appropriate screws and washers. Tighten the screws in a clockwise direction.

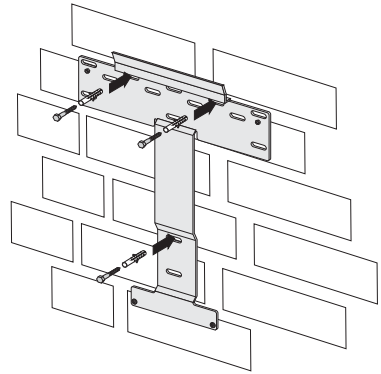

⚠ CAUTION

Risk of injury due to the Sunny Island falling during transport or mounting

Physical injury (fractures or crushing) and damage to the Sunny Island.

- Take the weight of the Sunny Island of 139 lb (63 kg) into account.
- Use the recessed grips or steel bars for transporting and mounting.

5. Attach the Sunny Island to the wall mounting bracket.

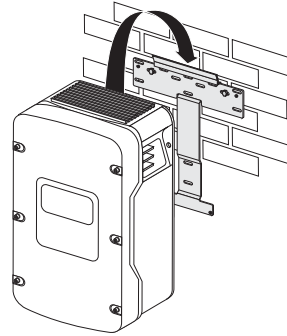

6. Screw the Sunny Island to the wall mounting bracket on both sides using the screws (M6x10) provided. Tighten the screws clockwise.
7. Make sure that the screws are securely in place.

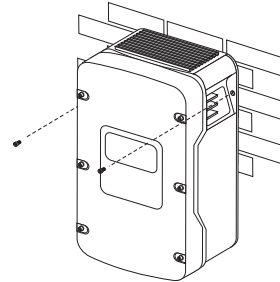

8. Close the recessed grips with the ventilation grids provided. To help you identify the sides, the ventilation grids are marked on the inside with "links/left" and "rechts/right".

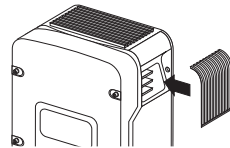

- The Sunny Island is mounted using the wall mounting bracket.

4.2.2 Mounting the Sunny Island using Wall Studs

⚠ CAUTION

Risk of injury due to the Sunny Island falling

Physical injury (fractures or crushing) and damage to the Sunny Island.

- Ensure that the wall can carry the weight of the Sunny Island.
- If mounting onto a wooden wall with studs, ensure that the wall mounting bracket is firmly connected with all studs.

If the Sunny Island is to be mounted on wall studs, then use the holes in the wall mounting bracket as shown in the figures. Ensure that the wall mounting bracket is positioned at least over one wall stud. Note that the wall mounting bracket is designed to mount on a single wall stud or on two wall studs. When mounting to wall studs, use a minimum of four 0.315 in (8 mm) lag screws with a minimum length of 2 in (50 mm).

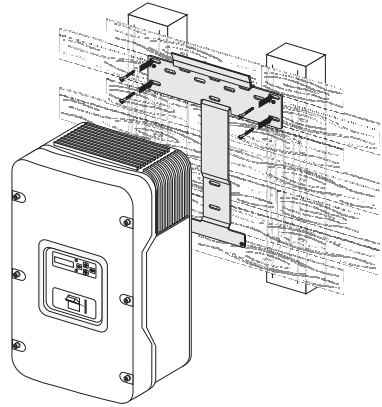

If two or more Sunny Island inverters are to be installed, mount the inverters on two studs each in order to get better cooling. Make sure that the wall where you intend to install the Sunny Island is vertical and can carry the weight of the Sunny Island (139 lb, 63 kg) on a long-term basis.

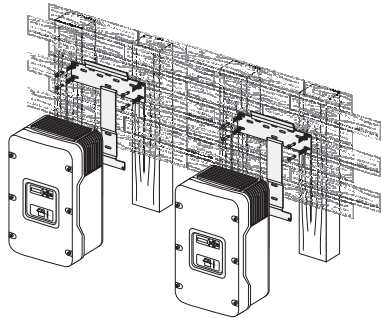

Otherwise proceed as per the mounting on a stone wall (see Section 4.2.1 "Mounting the Sunny Island on a Stone Wall", page 34).

5 Opening and Closing

The enclosure of the Sunny Island has a removable lid. Remove the enclosure lid only when installing the device or for required maintenance or repair work.

5.1 Opening the Sunny Island

1. Stop the Sunny Island (see Section 9.2 "Stopping the Sunny Island (Standby)", page 76).
2. Disconnect the Sunny Island from voltage sources (see Section 9.4 "Disconnecting the Device from Voltage Sources", page 76).
3. Ensure that the system cannot be accidentally switched on again.

⚠ WARNING

Danger to life due to high voltages in the Sunny Island

Death or serious injury possible due to electric shock.

- Wait 15 minutes before opening the Sunny Island until its capacitors are discharged.

⚠ CAUTION

Risk of burns due to hot components

Some components of the Sunny Island can get very hot during operation. Touching these components can cause burns. Heat build-up can cause burns.

- During operation, do not touch any parts other than the enclosure lid of the Sunny Island.
- When the Sunny Island is open, do not touch hot surfaces.

4. Loosen all six screws on the enclosure lid and set them aside.

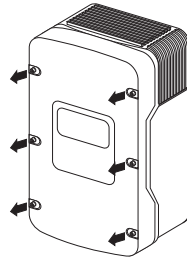

5. Remove the enclosure lid and set it aside.
- The Sunny Island is open.

5.2 Closing the Sunny Island

⚠ DANGER

Electric shock due to live enclosure lid

Death or serious injuries.

The grounding of the lid is ensured by the toothed washers.

- Fasten the washers for all six screws with the tothing facing toward the enclosure lid.

1. Place the enclosure lid onto the enclosure and fasten with the six screws and the corresponding washers in the sequence depicted on the right. Tighten the screws with a torque of 53 in-lb (6 Nm).

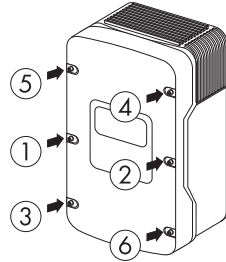

2. Commission the Sunny Island as described in Section (see Section 9.1 "Switching On", page 75).
- The Sunny Island is closed and in operation.

6 Electrical Connection

All cables are routed through the openings on the bottom side of the device (see next illustration) and connected to the appropriate terminals on the Sunny Island.

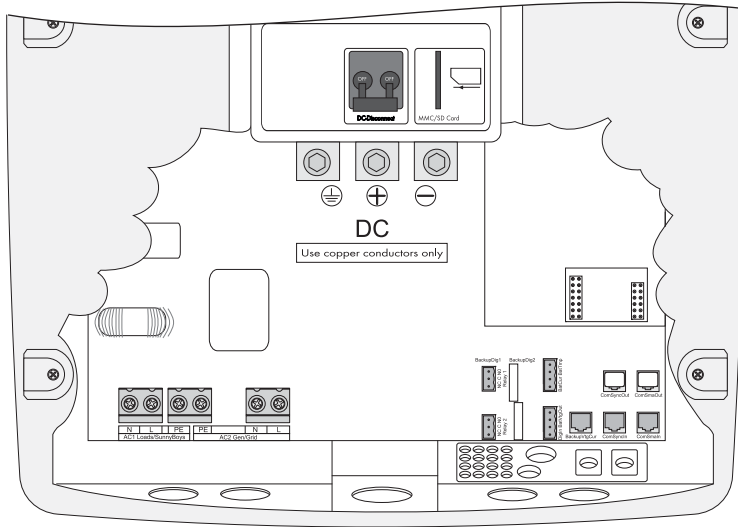

Use conduits to install the cables on the DC side and on the AC side on the Sunny Island. Conduits ensure the dust-tight and water-tight mounting of a cable on the enclosure and also serve as a strain relief of the cable at the terminal. Close all unused openings in the enclosure using the appropriate filler plugs.

Use the provided terminals to connect the cables inside the Sunny Island enclosure in a manner conforming to the appropriate standards.

Obtain an overview of the different devices and connection areas of the Sunny Island (see Section 2.2 "At a Glance", page 22).

Refer to the table below for the appropriate torque values and cable sizes.

Terminal	Torque	Cable size	Cable type
DC connections	21 ft-lb (28 Nm)	AWG 6 to AWG 3/0 (16 mm ² to 95 mm ²)	Only use copper conductors. These cables must be approved for 167°F (75°C).

Terminal	Torque	Cable size	Cable type
AC terminals	22 in-lb (2.5 Nm)	AWG 4 (25 mm ²)	Only use copper conductors. These cables must be approved for 167°F (75°C).
Additional Connections	5 in-lb to 7 in-lb (0.56 Nm to 0.79 Nm)	AWG 30 to AWG 12 (0.05 mm ² to 4 mm ²)	Only use copper conductors. These cables must be approved for 167°F (75°C).

An overview of the different devices and their connection areas of the Sunny Island 4548-US / 6048-US can be found in section (see Section 2.2 "At a Glance", page 22).

Detailed installation descriptions of the connections are provided in the following sections:

- Grounding (see Section 6.5 "Interface for External Communication", page 62)
- DC Connection (see Section 6.2 "DC Connection", page 43)
- AC Connection (see Section 6.3 "AC Connection", page 48)
- Data Cable of the Lithium-Ion Battery (see Section 6.4.2 "Connecting the Data Cable of the Lithium-Ion Batteries", page 53)
- Battery Temperature Sensor (see Section 6.4.3 "Battery Temperature Sensor", page 53)
- Battery Current Sensor (see Section 6.4.4 "Battery Current Sensor", page 54)
- Communication for Multi-Device Connection (see Section 6.4.5 "Communication for Multi-Device Connection", page 56)
- Multifunction Relay 1 and 2 (see Section 6.4.6 "Multifunction Relay 1 and 2", page 58)
- External Communication (see Section 6.5 "Interface for External Communication", page 62)

6.1 Grounding

⚠ WARNING

Danger to life due to electric shock

- Fuse the sub-distribution of the generator or the utility grid at input AC2 of the Sunny Island with an overcurrent protective device (Branch Circuit Protection).
- Ensure that the overcurrent protective device complies with the specifications of the *National Electrical Code*[®], ANSI/NFPA 70.
- Use an overcurrent protective device for a maximum of 70 A.

⚠ WARNING

Danger to life from electric shock due to faulty grounding

To allow different types of grounding, the N connection of the Sunny Island is **NOT** connected to PE at the factory. However, since a connection between N and PE is required for correct operation, this must be done outside of the device.

- Before commissioning, connect the Sunny Island 4548-US/6048-US and all other devices of the stand-alone grid to a grounded utility grid.
- Take the *National Electrical Code*[®], ANSI/NFPA 70, and all locally applicable standards and directives into consideration.



External grounding of the negative terminal of the battery

External grounding of the negative terminal of the batteries is possible because the batteries and the grid side are galvanically insulated within the Sunny Island.

- Dimension the cross-section of the grounding conductor sufficiently. Thus, you are ensuring that in the event of a fault the high currents occurring can be discharged with an external grounding.
- If grounding of the negative terminal of the battery is necessary, assemble this outside of the Sunny Island.

Connecting the Grounding Conductor

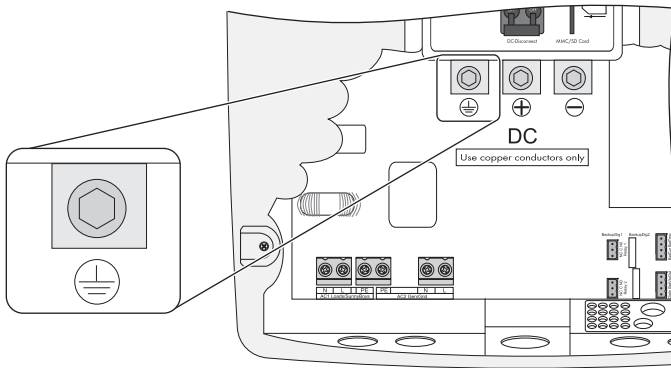

1. Install a conduit with a diameter of $1\frac{1}{2}$ in. (38.1 mm) at the opening in the center of the Sunny Island. Attach the conduit in the inside of the Sunny Island using the appropriate nut.
 2. Pull the cable with the grounding conductor through the supply line from the inside of the distribution board into the enclosure of the Sunny Island.
 3. Strip off the insulation of the grounding conductor.
 4. Plug the grounding conductor into the DC terminal for grounding and tighten the fastening screw with a torque of 21 ft-lb (28 Nm). Use an Allen key (8 mm).
- The grounding conductor is connected.

Calculating the cross-section of a grounding conductor

SMA cannot state generally valid values for the cross-section of the grounding conductor required for the external grounding of the battery. The conductor dimensions depend on the type and size of the battery connected, the external fuse (DC side) and the material used for the grounding conductor.

i Calculating the grounding conductor cross-section according to applicable standards

Exact calculation of the grounding conductor cross-section must take account of the regionally applicable standards and directives (e.g. *National Electric Code*® Article 250.122).

6.2 DC Connection

NOTICE

Function impairments of devices on the DC busbar

The Sunny Island is **not** suitable for use with DC supply grids. Function impairment can occur on devices installed on the DC side of a Sunny Island with cables exceeding 98 ft (30 m) and with a flexible connection.

- Only use fixed installations.
- Do not use cables of lengths greater than 98 ft (30 m) between the Sunny Island and the battery and/or DC device.

6.2.1 Safety Precautions/Conditions

Connect a suitable battery to the DC side (see Section 22 "Technical Data", page 227). The DC connection must be made in accordance with all locally applicable directives and directives.

WARNING

Danger to life due to explosive gases

Explosive gases may escape from the battery and cause an explosion. This can result in death or serious injury.

- Protect the battery environment from open flames, embers, or sparks.
- Install, operate, and maintain the battery in accordance with the manufacturer's specifications.
- Do not heat the battery above the temperature permitted or burn the battery.
- Ensure that the battery room is sufficiently ventilated.

WARNING

Chemical burns and poisoning due to battery electrolyte

If handled inappropriately, battery electrolyte can cause irritation to the eyes, respiratory system, and skin, and it can be toxic. This may result in blindness and serious chemical burns.

- Protect the battery enclosure against destruction.
- Do not open or deform the battery.
- Whenever working on the battery, wear suitable personal protective equipment such as rubber gloves, apron, rubber boots and goggles.
- Rinse acid splashes thoroughly with clear water and consult a doctor.
- Install, operate, maintain, and dispose of the battery according to the manufacturer's specifications.

⚠ WARNING**Risk of injury due to short-circuit currents**

Short-circuit currents in the battery can cause heat build-up and electric arcs. Burns or eye injuries due to flashes may result.

- Remove watches, rings, and other metal objects.
- Use insulated tools.
- Do not place tools or metal parts on the battery.

⚠ WARNING**Danger to life due to incompatible lithium-ion battery**

An incompatible lithium-ion battery can lead to a fire or an explosion. Use of incompatible lithium-ion batteries can also make the user's battery management system unsafe, and void manufacturers' warranties. To avoid fire or explosion, we strongly recommend doing the following:

- Verify that the battery complies with locally applicable standards and directives, and is intrinsically safe.
- Verify that the particular lithium-ion battery type is approved for use with the SMA Sunny Island inverter (please see "List of Approved Lithium-Ion Batteries" under the Technical Information tab at www.SMA-America.com).
- If manufacturer approved Sunny Island lithium-ion batteries are not available, you may use lead acid batteries.

**Ampacity of lithium-ion batteries in off-grid systems**

In order to meet the requirements of off-grid systems, the Sunny Island has a high overload capacity. This overload capacity requires the battery to supply sufficient current. With lithium-ion batteries, this ampacity cannot be taken for granted.

- Check with the battery manufacturer whether the battery is suitable for off-grid systems with Sunny Island inverters. Pay special attention to the ampacity.

**Lithium-ion batteries on the Sunny Island require firmware version 7.3**

When using lithium-ion batteries on the Sunny Island, the firmware version must be at least 7.3.

- Before connecting a lithium-ion battery to the Sunny Island, check whether the Sunny Island has at least firmware version 7.3.
- If the Sunny Island has an older firmware version, update the firmware (see Section 11.6 "Firmware Update", page 100).

6.2.2 Cable Dimensioning

i Keep the cables to the battery as short as possible

The battery cables should be as short as possible. Long cables and insufficient wire sizes reduce the system efficiency as well as the overload capacities. Do not lay the battery cable under plaster or in armored conduits.

i Choosing the wire size

For cable lengths exceeding 33 ft (10 m), SMA recommends choosing wire sizes greater than those given by the *National Electrical Code*® 310.15.

Example for Cable Dimensioning

With a 48 V battery voltage and an outgoing AC power of 4,500 W, a current of up to 100 A flows through the SI 4548-US-10 battery cable. At the same battery voltage and an outgoing AC power of 6,000 W, a current of up to 130 A flows through the battery cables of the SI 6048-US-10.

The current flowing through the battery cables causes a power loss and a voltage drop with every meter. Refer to the following table for the power loss and voltage drop associated with different wire sizes.

Wire size	Power loss	Voltage drop
AWG 2/0 (70 mm ²)	1.8 W/ft (6 W/m)	14 mV/ft (45 mV/m)
AWG 3/0 (95 mm ²)	1.4 W/ft (4.7 W/m)	11 mV/ft (35 mV/m)

Example:

For a distance of 33 ft (10 m) between the Sunny Island and the battery, at least 66 ft (20 m) of cable are needed (distance there and back). Using a wire size of AWG 2/0 (70 mm²), 100 A (nominal current of the battery) causes a power loss of 120 W in total and an effective voltage drop of 0.9 V.

Calculation of the averaged nominal current of the battery

You can calculate the averaged nominal current of the connected battery using the following formula:

$$I_{\text{Bat}} = \frac{P_{\text{AC}}}{U_{\text{Bat}} \cdot \eta_{\text{INV}}}$$

I_{Bat} = Nominal current of the battery

P_{AC} = AC power of the inverter

U_{Bat} = Nominal voltage of the battery

η_{INV} = Inverter efficiency at a given AC power

6.2.3 Cable Protection

The DC circuit breaker in the Sunny Island can interrupt DC currents of up to 10 kA. In addition to the internal DC circuit breakers, install a separate, external fuse as close as possible to the battery. Install a fuse link for the fuse suitable for the maximum occurring DC currents.

⚠ DANGER

Electric shock resulting from insufficient protection of the DC cables

Death or serious burns.

- Check whether external cable protection is present.
- If no external cable protection is present, observe the following:
 - Lay the DC cable in such way that ground faults and short circuits cannot occur.
 - Install the additional current limiting fuse outside of the Sunny Island. When doing so, observe all locally applicable standards and directives.

6.2.4 Connecting the Sunny Island on the DC Side

⚠ WARNING

Danger to life due to electric shock

- Connect the external fuse and the battery cable to the battery only after all installation work has been completed.

⚠ CAUTION

Risk of burns due to hot battery components

Improper battery connection may result in excessively high transition resistances. Excessive transition resistances give rise to localized heat build-up.

- Ensure that all pole connectors are connected with the connecting torque specified by the battery manufacturer.
- Ensure that all DC cables are connected with the connecting torque specified by the battery manufacturer.

Requirements

- 1 conduit with a diameter of 1 1/2 in. (38.1 mm) is installed at the opening in the middle of the Sunny Island (see Section 6.1 "Grounding", page 41).
- The conduit is attached inside the Sunny Island with a suitable nut.

Installing the DC Connection

1. Pull the positive DC cable through the conduit from the distribution board into the enclosure of the Sunny Island.
2. Pull the negative DC cable through the conduit from the distribution board into the enclosure of the Sunny Island.
3. Remove the coating.
4. Strip the DC cable insulation.

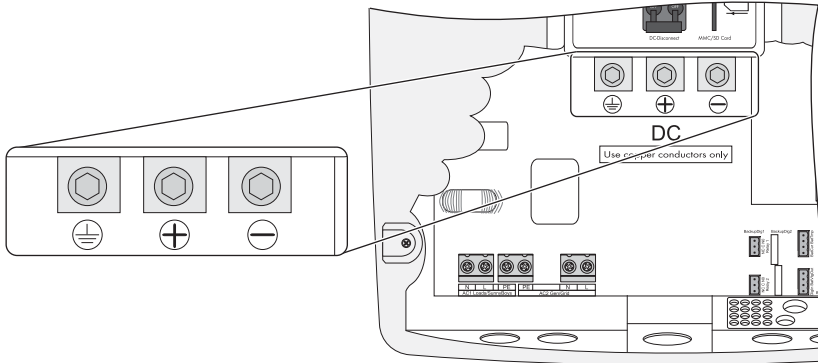

DC connection area

The areas between the stripped conductor and the connection area must be clean. This ensures that the transition resistance and the heating of the terminal points is reduced.

The Sunny Island has a DC terminal for a maximum of 3/0 AWG for DC+, DC- and grounding conductor.

5. Insert the negative DC conductor in the "DC-" terminal and tighten the fastening screw with a torque of 21 ft-lb (28 Nm). Use an Allen key (8 mm).
6. Insert the positive DC conductor in the "DC+" terminal and tighten the fastening screw with a torque of 21 ft-lb (28 Nm). Use an Allen key (8 mm).



DC cable

Do not connect any other devices to the DC cables. Other devices must be connected directly to the battery via separate cables.

6.3 AC Connection

6.3.1 Cable Protection

You must connect the Sunny Island via a sub-distribution to the stand-alone grid and any external source present.

Fit the sub-distribution with appropriate circuit breakers and observe all locally applicable standards and directives.

Fitting the sub-distribution with circuit breakers

The sub-distribution must be equipped with appropriate circuit breakers. Observe all locally applicable standards and directives.

Maximum permissible input current

The maximum input current allowed on the Sunny Island is 56 A. Higher input currents must not be connected to the Sunny Island.

No all-pole isolator on the Sunny Island

The Sunny Island is not equipped with an all-pole isolator. The neutral conductor (N conductor) is looped through the device and the N terminals of AC1 and AC2 are connected inside the Sunny Island.

6.3.2 AC1 (Loads/Sunny Boys)

The sub-distribution of the stand-alone grid (e.g. loads, PV inverter, wind power inverter) is connected to output AC1 of the Sunny Island.

CAUTION

Damage to the Sunny Island inverter due to excessive current load at output AC1

The output AC1 of the Sunny Island inverter may handle a current rating up to 56A. A higher current load at output AC1 may cause a cable fire, which can result in personal injury.

- A circuit breaker with a rated current of a maximum of 56A must be installed.

If you want to fuse individual load circuits in a 120 V grid separately, install circuit breakers with a rated current of up to 20 A: the Sunny Island can safely trip circuit breakers of up to 20 A.

If you install circuit breakers with a higher rated current, the Sunny Island may not trip these. In this case the DC breaker in the Sunny Island would trip and the Sunny Island would disconnect (see Section 9.5 "Recommissioning After Automatic Shutdown", page 77).

Cable lengths in single-phase, parallel, split-phase, double split-phase and three-phase systems

The AC cables between the Sunny Island and the sub-distribution of a system must have the same wire size and the same cable length for all parallel connected devices.

i Distributing loads and AC feed-in generators in multiple-phase systems

Distribute the feed-in power and the consumed power of the loads and AC feed-in generators as equally as possible across all line conductors of the system.

i Connection in a split-phase system

In a split-phase system, connect the master to line conductor L1 and the slave 1 to line conductor L2 (see Section 2.2 "At a Glance", page 22).

i Double-split-phase system

In a double split-phase system, connect the master and slave 2 to line conductor L1.

In a double split-phase system, connect slave 1 and slave 3 to line conductor L2.

i Connection in a three-phase system

Always install the master on line conductor L1, slave 1 on L2 and slave 2 on L3. This installation has a right-hand rotating magnetic field.

i Failure of a line conductor within a three-phase system

If in a three-phase system, a line conductor fails on the master, the cluster stops. If a line conductor fails on a slave, the cluster can either continue to operate or switch off. Whether the cluster continues to work or switches off depends on the setting of the parameter "250.30 RnMod" (see Section 19.2.5 "System Settings (250#)", page 191).

Connecting the AC1 cable:

i Wire size

The maximum wire size for connecting the loads/PV inverters is 4 AWG (25 mm²).

1. Install a conduit with a diameter of $\frac{3}{4}$ in. (19 mm) at the left opening on the left side of the Sunny Island enclosure. Attach the conduit on the inside of the Sunny Island with a counter nut.
2. Install the conduit on the distribution board.
3. Pull the cable from the distribution board through the conduit into the Sunny Island.
4. Remove the protective insulation of the three cables (insulation stripping length: 0.75 in (18 mm)).

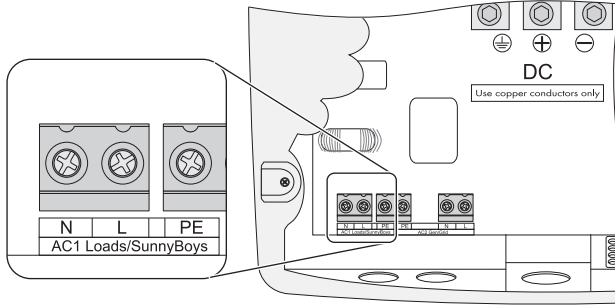

5. Insert the grounding conductor into the terminal labeled "AC1 Loads/Sunny Boys" and tighten the fastening screw with a torque of 22 in-lb (2.5 Nm). Use a torque wrench with flat-blade screwdriver bit SZS 1.0 x 6.5.
 6. Insert N and L into the terminals labeled "AC1 Loads/Sunny Boys" and tighten the fastening screws with a torque of 22 in-lb (2.5 Nm). Use a torque wrench with flat-blade screwdriver bit SZS 1.0 x 6.5.
- The AC1 cables are connected.

6.3.3 AC2 (Generator/Grid)

The sub-distribution of the generator or utility grid is connected at input AC2 of the Sunny Island.

i Cable lengths in single-phase, parallel, split-phase, double split-phase and three-phase systems

The AC cables between all Sunny Island inverters and generator or the utility grid of a system must have the same wire size and the same cable length.

i Single-phase parallel system

In the case of single-phase parallel systems, also connect the generator or the utility grid to all slaves on AC2. The wire sizes and cable lengths used must be identical.

i Distribution of loads and AC feed-in generators in multi-phase systems

Distribute the feed-in power and consumption power of the loads as well as the AC feed-in generators as equally as possible across all line conductors of the system.

i Split-phase system

In a split-phase system, connect the master to line conductor L1 and the slave 1 to line conductor L2 (see Section 2.2 "At a Glance", page 22).

i Double-split-phase system

In a double split-phase system, connect the master and slave 2 to line conductor L1.

In a double split-phase system, connect slave 1 and slave 3 to line conductor L2.

i Three-phase system

Always install the master on line conductor L1, slave 1 on L2 and slave 2 on L3. This installation has a right-hand rotating magnetic field.

i Additional fuses in the system

If there are no additional fuses installed between the generator or utility grid and the Sunny Island, the Sunny Island knows whether it has a connection to the utility grid/to the generator. The Sunny Island can then draw current from the utility grid/from the generator.

If there are additional fuses or switches installed between the Sunny Island and the utility grid/the generator, the Sunny Island cannot determine whether fuses or switches are disconnected or whether there is no voltage available from the utility grid/the generator. In either case the Sunny Island cannot charge its battery and the loads that are in operation will discharge the Sunny Island battery.

Check the additional fuses and switches regularly in order that the Sunny Island battery only discharges when there is no voltage available from the utility grid/the generator.

Connecting the AC2 Cable (Generator/Grid):

i Wire size

The maximum wire size for connecting the generator is 4 AWG (25 mm²).

1. Install a conduit with a diameter of $\frac{3}{4}$ in. (19 mm) at the right opening on the left side of the Sunny Island enclosure. Attach the conduit on the inside of the Sunny Island with a counter nut.
2. Install the conduit on the distribution board.
3. Pull the cable from the distribution board through the conduit into the Sunny Island.
4. Remove the protective insulation of the three cables (insulation stripping length: 0.75 in (18 mm)).

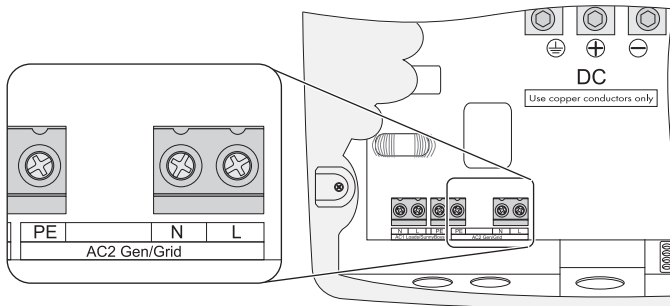

5. Insert the grounding conductor into the terminal labeled "AC2 Gen/Grid" and tighten the fastening screw with a torque of 22 in-lb (2.5 Nm). Use a torque wrench with flat-blade screwdriver bit SZS 1.0 x 6.5.

6. Insert N and L into the terminals labeled "AC2 Gen/Grid" and tighten the fastening screws with a torque of 22 in-lb (2.5 Nm). Use a torque wrench with flat-blade screwdriver bit SZS 1.0 x 6.5.

6.4 Additional Connections

6.4.1 Inserting the Data Cables

For installing the connections described in the following sections, lead the data cables through the specified holes in the cable support sleeve. Plugs for sealing the RJ45 data cables for internal and external communication are provided in the plastic flange plate upon delivery. Through a combination of the plugs there are up to four feed-throughs (two plugs without a feed-through, one plug with one feed-through and two plugs with two feed-throughs). Insert the necessary plugs with feed-through to attach the data cables.

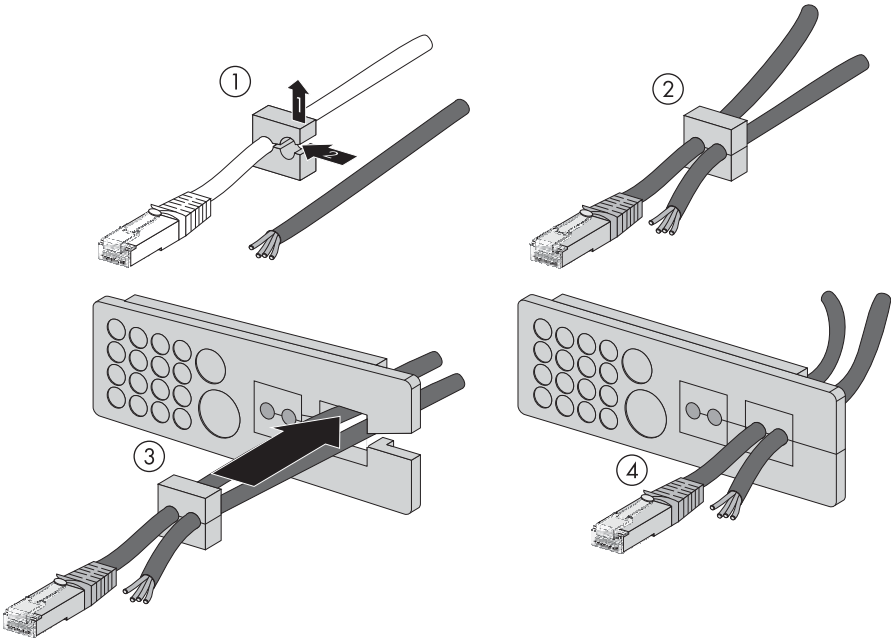

6.4.2 Connecting the Data Cable of the Lithium-Ion Batteries

Requirements:

The total length of the communication bus must not exceed 98 ft (30 m). Keep in mind that the communication bus possibly connects several nodes such as additional Sunny Island inverters.

The data cable must be a CAT5 cable with RJ45 plugs.

1. Plug the data cable into a free pin connector ComSync on the Sunny Island.

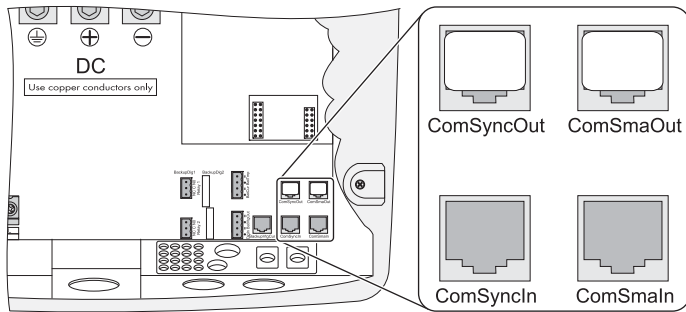

2. Connect the other end of the data cable to the battery management of the lithium-ion battery (see battery manufacturer documentation).
3. Ensure that the communication bus is closed at each end, e.g. with a terminator.

6.4.3 Battery Temperature Sensor

The battery temperature sensor measures the temperature of the connected battery. For lead-acid batteries, this is necessary since the optimum charging voltage for a battery strongly depends on the temperature (see Section 13.5 "Charge Control", page 111). For lithium-ion batteries, the external battery management transfers the battery temperature to the Sunny Island and thus replaces the battery temperature sensor.

The battery temperature sensor must be connected for the operation of the Sunny Island (included in the scope of delivery). In case of a fault (short circuit, cable break), the Sunny Island operates in a safe setting, which over time leads to deep discharge of the battery. A warning indicating that the defective battery temperature sensor should be replaced immediately is displayed.

NOTICE

Destruction of the battery through deep discharge as a result of the installation of an unsuitable battery temperature sensor

- Only use the battery temperature sensor included in the scope of delivery.
- Do not drill holes into the battery to install the battery temperature sensor.

i Battery temperature sensor in a cluster

A battery temperature sensor is provided with each Sunny Island. Only one battery temperature sensor is required for a cluster. Connect the temperature sensor to the master of the cluster.

Connecting the Battery Temperature Sensor

i Polarity of the conductors

The polarity of the two conductors is irrelevant for the functioning of the battery temperature sensor.

1. Pierce a hole at a suitable location in the cable support sleeve using a sharp object.
2. Starting from the outside, lead the insulated conductors with bootlace ferrules through the hole in the Sunny Island.

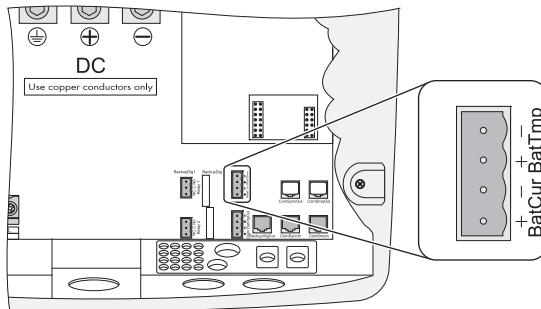

3. Connect the insulated conductors correspondingly to the "BatVtgOut" terminal of the four-pole terminal included in the delivery.
4. Tighten the terminals (torque: 5 in-lb to 7 in-lb (0.56 Nm to 0.79 Nm)).
5. Insert the 4-pole terminal into the "BatTemp" pin connector on the Sunny Island.
6. Attach the battery temperature sensor to the outside of one of the battery cells. Choose a spot between two cells and in the central area of the battery storage system. The heat generation during operation is the greatest there.

6.4.4 Battery Current Sensor

In addition to the internal measurement, the Sunny Island provides the possibility to measure the battery current via a shunt. You need this function if you intend to operate additional DC generators and DC loads in your off-grid system. Only one battery current sensor is necessary in a cluster; this is to be connected to the cluster master.

NOTICE

Destruction of the battery due to the connection of additional DC devices

If additional DC devices are installed in an off-grid system, the internal Sunny Island current measurement becomes inaccurate. The charge current can no longer be set exactly and as a result will destroy the battery.

- Install an external battery current sensor (shunt).

Example:

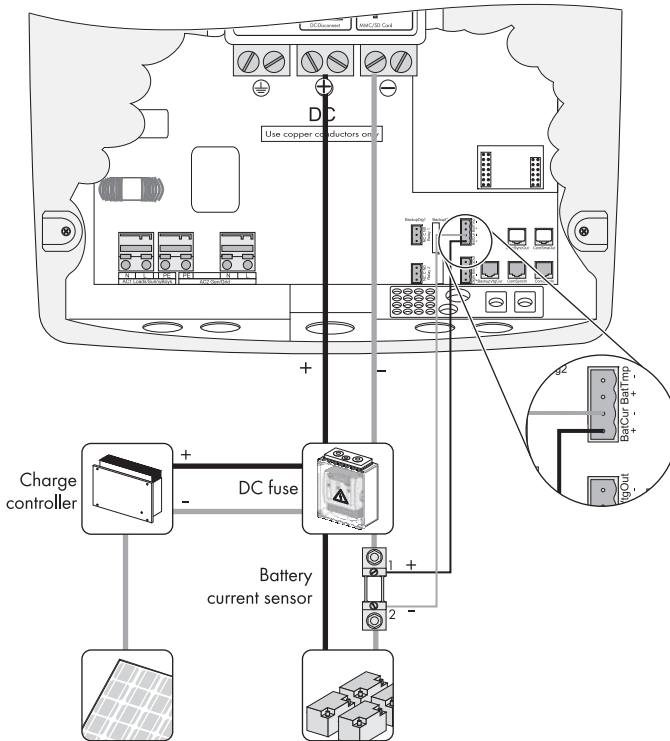

Connecting the Battery Current Sensor

i Use cables of intrinsically safe circuits

Always use cables for intrinsically safe electric circuits for connecting the battery current sensor. Intrinsically safe means that the cable is double-insulated and that in the event of a short-circuit the wire melts but the insulation remains intact. In addition, the cable is not combustible. In order to avoid measuring errors, make sure that the cable conductors are twisted.

i Installation notice

The battery current sensor must be looped around the negative terminal of the battery. The terminal of the battery current sensor which is connected to the Sunny Island (1), must be connected to the terminal "BatCur+" (see example).

- Positive battery current means that the battery is being discharged (current from the battery).
 - Negative battery current means that the battery is being charged (current into the battery).
1. Pierce a hole at a suitable location in the cable support sleeve using a sharp object.
 2. Starting from the outside, lead the insulated conductors with bootlace ferrules through the hole in the Sunny Island.
 3. Connect the insulated conductors correspondingly to the "BatVtgOut" terminal of the 4-pole terminal included in the delivery.
 4. Tighten the terminals (torque: 5 in-lb to 7 in-lb (0.56 Nm to 0.79 Nm)).
 5. Insert the 4-pole terminal into the "BatTmp" pin connector on the Sunny Island.
- The battery current sensor is installed.

i Commissioning the battery current sensor

When connecting a battery current sensor to the Sunny Island, you must set the device-internal offset during the initial start-up of the off-grid system on the Sunny Island as described (see Section 8.3 "Commissioning the battery current sensor", page 73).

6.4.5 Communication for Multi-Device Connection

The Sunny Island can be connected in parallel, as a split-phase system or in a three-phase system with other Sunny Island inverters in order to increase the overall power. The Sunny Island inverters communicate with each other via an RJ45 data cable. A black RJ45 cable is provided with each Sunny Island. You need it in order to establish an (internal) communication between several Sunny Island inverters. The maximum overall length of the communication bus of 98 ft (30 m) must **not** be exceeded. If you operate only one Sunny Island in your system, the cable is not required.

Proceed as follows to implement the connection:

1. Remove one of the two plugs from the cable support sleeve.
2. Lead the RJ45 cable from the outside through the plugs inside the master.
3. Remove the terminator plugged into the "ComSyncOut" pin connector of the master and insert it in "ComSyncln" pin connector of the master.
4. Plug the RJ45 cable into the "ComSyncOut" pin connector.
5. Connect the master with slave:

Number of slaves	Connection procedure
1 slave	<ul style="list-style-type: none"> • Take the RJ45 cable coming from the master, insert it into the slave and plug it into the "ComSynIn" pin connector. • Leave the terminator plugged into the "ComSynOut" pin connector. <p><input checked="" type="checkbox"/> Master and slave are connected.</p>
2 slaves	<ul style="list-style-type: none"> • Lead the RJ45 cable coming from the master into slave 1 and plug it into the "ComSynIn" pin connector. • Remove the terminator in the slave 1 from the "ComSynOut" pin connector. • Plug the RJ45 cable included in the scope of delivery into the "ComSynOut" pin connector of slave 1. • Lead the RJ45 cable coming from slave 1 into slave 2 and plug it into the "ComSynIn" pin connector. <p><input checked="" type="checkbox"/> The master and the slaves are connected.</p>

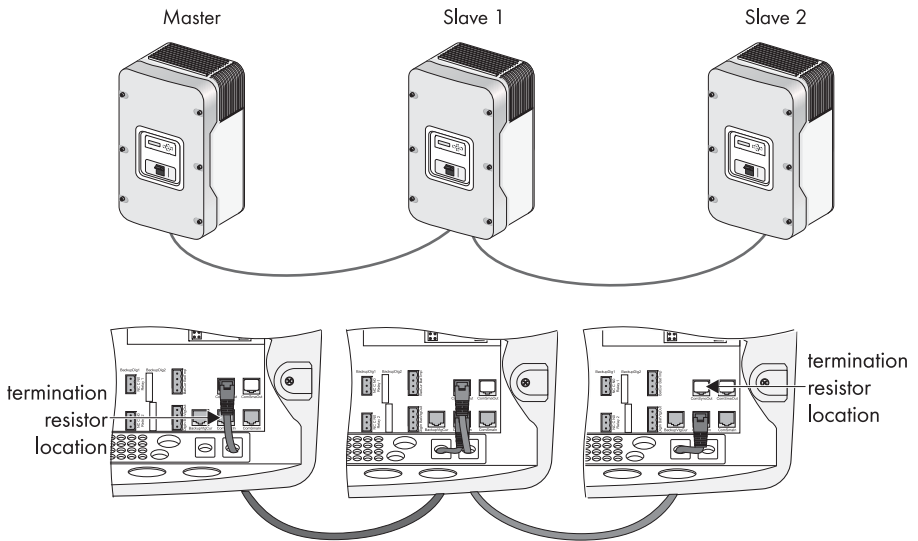

6.4.6 Multifunction Relay 1 and 2

The Sunny Island offers you several options for the control of internal and external processes. Two multi-function relays are integrated into the Sunny Island to which you can assign functions using the parameters "241.01 Rly1Op" and "241.02 Rly2Op" (see Section 15 "Relays", page 140).

We recommend connecting the load shedding and generator request functions to the master, since, if a failure occurs, the slave may be waiting for a confirmation, but the master continues to operate and the device can at least operate in a limited capacity.



Operating principles of the relays

The relays are changeover contacts; they can be used as break contact (NCC) or as make contact (NOC).

You can only assign one function to each relay!

Connection to the Relay Contact

⚠ WARNING

Danger to life from electric shock due to incorrect insulation

- Securely disconnect the insulated conductors leading to the relay contact from the communication area and the AC area.
- Strip off the insulation of the conductor leading to the relay contact.
- Sheathe the silicon tube included in the delivery via the insulated conductors used in the relay contacts.
- Never operate the Sunny Island without silicone tube.

1. Pierce a hole at a suitable location in the cable support sleeve using a sharp object.
2. Starting from the outside, lead the insulated conductors with bootlace ferrules through the hole in the Sunny Island.
3. Cut an appropriate piece from the silicone tube (included in scope of delivery) and pull it over the insulated conductors.

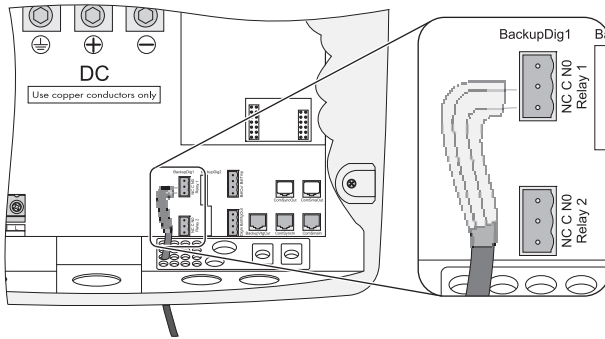

4. Connect the insulated conductors to the supplied three-pole terminal. The pins have the following meaning:
 - NC: normally closed (when the Sunny Island is off, the relay is closed)
 - C: Contact (front contact)
 - NO: normally opened (when the Sunny Island is off, the relay is open)
5. Tighten the terminals (torque: 5 in-lb to 7 in-lb (0.56 Nm to 0.79 Nm)).
6. Insert the three-pole terminal into corresponding pin connector on the Sunny Island.

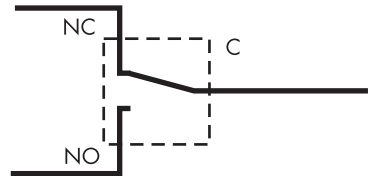

Power Contactor for Load Shedding

The Sunny Island can automatically disconnect loads to protect the battery from deep discharge. An external (AC or DC) power contactor must be installed between the Sunny Island and the loads (see Section 12.1 "Load Shedding", page 103).

Installing the power supply of a DC power contactor for load shedding (e.g. relay2):

i **Power supply of the DC power contactor**

A voltage of 48 V supplied by the battery is present in the control circuit.

- Load the BatVtgOut terminals with a maximum of 0.75 A.
1. Connect the A1 coil terminal of the power contactor to the terminal NO (Relay2).
 2. Wire terminal C (Relay2) to the terminal "BatVtgOut +".
 3. Wire the A2 coil connector of the power contactor to the terminal "BatVtgOut -".
- The control circuit of the power contactor is installed.

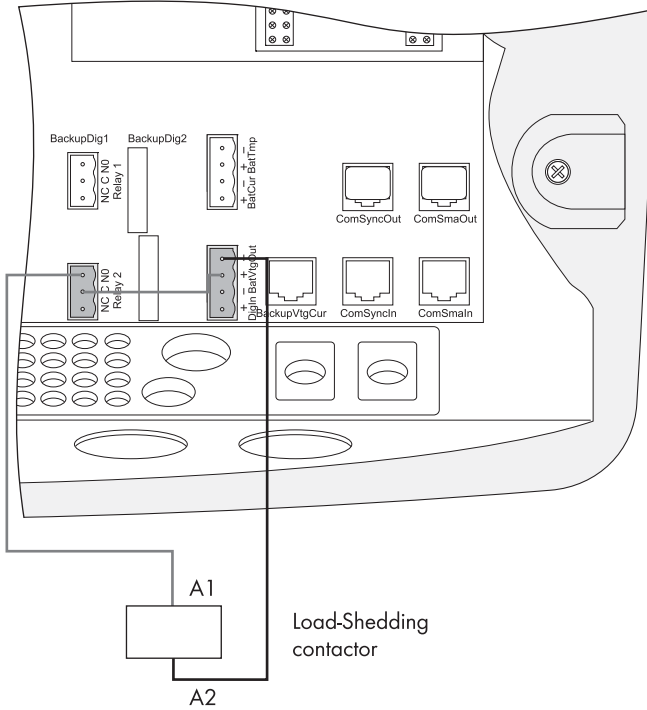

Generator start

The Sunny Island can control generators. The Sunny Island directly supports generators that can be started/stopped using a single contact.

i **Default settings of the relays**

Relay 1 is preset to the "AutoGn" generator start function and relay 2 to the "AutoLodSoc" load shedding function.

6.4.7 BatVtgOut Power Supply

The battery voltage is conducted to the outside at these terminals. The battery voltage is fused at both poles by PTC resistors (max. 0.75 A). Depending on the internal temperature of the Sunny Island, the tripping threshold is over 0.75 A.

This connection can be used, for example, to supply a DC contactor for load shedding.

Connecting the BatVtgOut Voltage Supply

1. Pierce a hole at a suitable location in the cable support sleeve using a sharp object.
 2. Starting from the outside, lead the insulated conductors with bootlace ferrules through the hole in the Sunny Island.
 3. Connect the insulated conductors to the "BatVtgOut" terminal of the 4-pole terminal.
 4. Tighten the screws of the terminal (torque: 5 in-lb to 7 in-lb (0.56 Nm to 0.79 Nm)).
- The BatVtgOut voltage supply is connected.

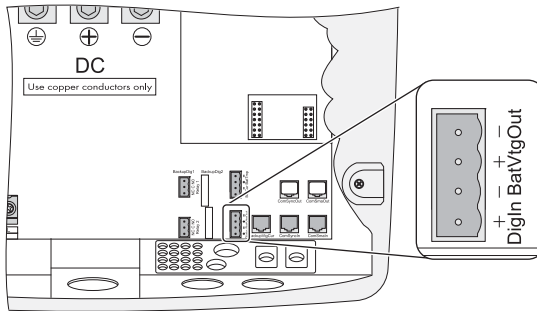

6.4.8 DigIn Digital Input

The DigIn connection is used as a digital input for external electrical sources.

i Area of the input voltage at the DigIn input

A voltage of between 5 V and 63 V may be present at the digital input DigIn.

i Corresponding functions

If you operate the system in mixed operation with generator and utility grid (GenGrid) in parallel, use the relays on the master device in order to activate the corresponding functions.

Connecting the DigIn Digital Input

1. Pierce a hole at a suitable location in the cable support sleeve using a sharp object.
2. Starting from the outside, lead the insulated conductors with bootlace ferrules through the hole in the Sunny Island.
3. Connect the insulated conductors correspondingly to the "DigIn" terminal of the 4-pole terminal.

4. Tighten the screws of the terminal (torque: 5 in-lb to 7 in-lb (0.56 Nm to 0.79 Nm)).

The DigIn digital input is connected.

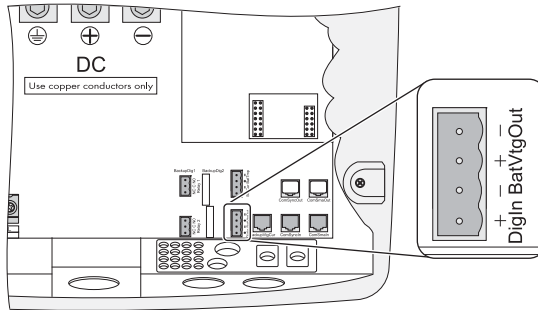

6.5 Interface for External Communication

You can connect SMA communication devices (e.g. Sunny WebBox) or a PC with the appropriate software to a communication interface. You will find a detailed wiring diagram in the communication device manual, the software or on the Internet at www.SMA-America.com.

You can incorporate an RS485 communication interface into the Sunny Island.

i Powerline/Powerline modem (PLM)

Communication via Powerline (PLC) is not possible in off-grid systems.

i Communication in a cluster

Fitting a communication interface in a cluster is only necessary on the master.

6.5.1 Connection of the Interface for External Communication

NOTICE

Destruction of the communication interface through electrostatic discharge

Internal components of the Sunny Island can be irreparably damaged by electrostatic discharge.

- Ground yourself before touching components.

i Interface for external communication in battery-backup systems

If a battery-backup system is connected to the Sunny Island, the RS485 communication between the Sunny Island and the PV inverters is necessary. For this, the following devices each need one RS485 interface:

- the Sunny Island (if there are several Sunny Island inverters, the Sunny Island master)
- each PV inverter

Connecting the Interface for External Communication

1. Remove the right-hand plug from the cable support sleeve.

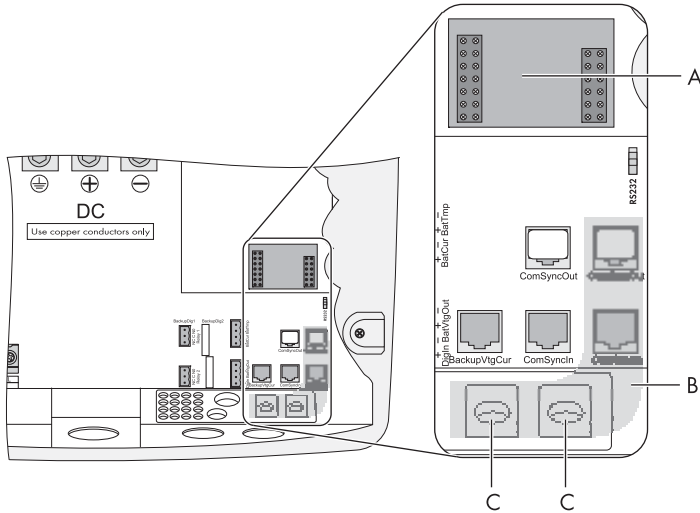

Position	Description
A	Slot for communication interface
B	Cable route
C	Enclosure opening in the floor of the Sunny Island

2. Lead the cable from the outside through the enclosure opening (C) into the interior of the Sunny Island.
3. Plug the cable into the "ComSmaIn" pin connector.
4. Fit the plug around the cable.
5. Plug the plug back into the designated opening in the cable support sleeve.
6. Lay the cable in the cable route (B).
7. Connect the insulated conductors. Assignment pins in the RJ45 pin connector:

Sunny Boy/ Sunny WebBox	RS485 – Signal allocation	RJ45 pin connector - Sunny Island	RJ45 plug color code
2	A (Data+)	3	white with green stripes
5	GND	2	orange with white stripes

Sunny Boy/ Sunny WebBox	RS485 – Signal allocation	RJ45 pin connector - Sunny Island	RJ45 plug color code
7	B (Data-)	6	green with white stripes

- The RS485 data bus of the Sunny Island is terminated using a terminator. This terminator is already plugged into the "ComSmaOut" pin connector. Only remove the plug if you want to connect another communication device.
- Plug the communication interface in slot (A).

Connecting the Sunny Island to the Sunny Boy and the Sunny WebBox with an RS485 Cable

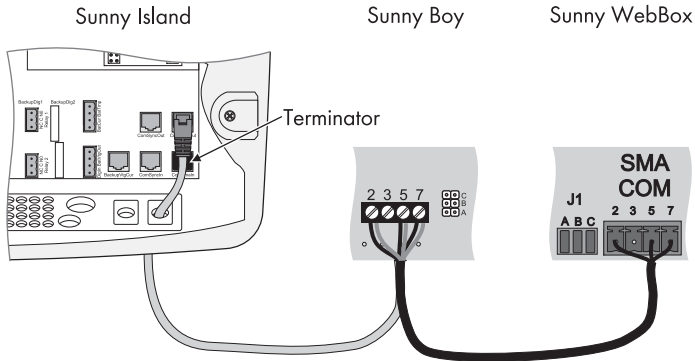

Connecting the Sunny Island to the Sunny Boy and the Sunny WebBox with Separate RS485 Cables

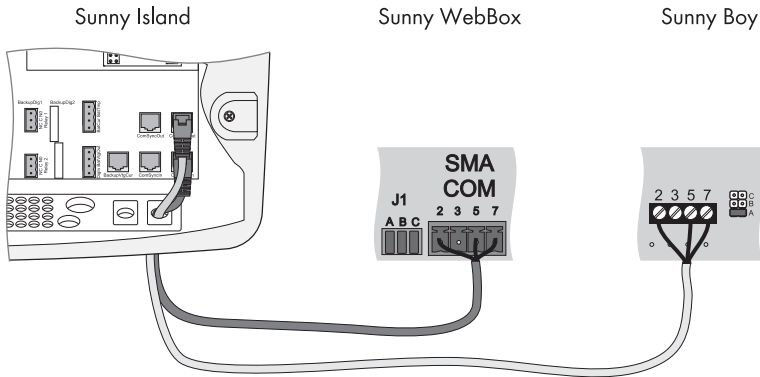

Data Transmission Speed

The Sunny Island can be operated at different data transfer rates to communicate with external devices. Set the parameter "250.06 ComBaud".



Setting the baud rate

If PV inverters are connected to the communication bus, then the baud rate must be set to 1,200 bps (default setting).

7 Control Elements

In order to commission the Sunny Island, you should familiarize yourself with its operation beforehand. The individual control elements can be seen in the following figure.

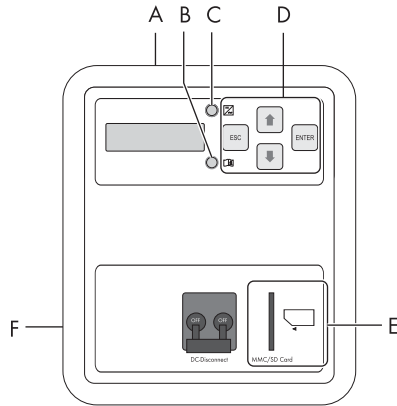

Position	Description
A	Display
B	Red LED
C	Green LED
D	Control buttons
E	Slot for the SD memory card
F	DC Circuit Breaker

7.1 Display Messages

The display of the Sunny Island has two lines, each with 16 characters.

i **Meaning of the symbols**

Observe the information on the meaning of the individual symbols (see Section 10.6 "Display Messages (Overview)", page 89).

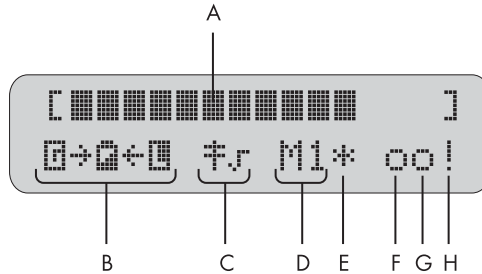





Position	Description
A	Output power/charging power (load status)
B	Direction of energy flow and system status
C	Displays if the Sunny Island loaded parameters for grid operation or parameters for generator operation.
D	Device assignment
E	Status of the external source (asterisk, question mark or exclamation mark)
F	Relay 1 status
G	Relay 2 status
H	Warning message (exclamation mark)

7.2 DC Circuit Breaker

The DC circuit breaker is used to switch on/off as well as to disconnect the Sunny Island on the DC side (see Section 9 "Switching On and Off", page 75).

7.3 Buttons

The table explains the functions of the buttons on the Sunny Island:

Button	Function
	<ul style="list-style-type: none"> cancels the selected function answers NO navigates one menu level higher stops device (when held pressed down)
	navigates up one list element, increases data value
	navigates down one list element, decreases data value
	<ul style="list-style-type: none"> selects function selects value confirms change answers YES navigates one menu level down starts device (when held pressed down) stops device (when held pressed down)

7.4 Meaning of the Light-Emitting Diodes (LED)

On the Sunny Island control panel, there are both a green (above) and a red (below) light emitting diode (LED), the functions of which are described in the table below:

Green LED	Red LED	Operating state
-	-	Off
On	-	Operation or Standby
-	On	Disturbance or error

7.5 SD Memory Card

The Sunny Island features an SD memory card which can be used for updating firmware and as a service interface (see Section 11 "Data Storage on SD Memory Card", page 94).

8 Commissioning

8.1 Requirements

Checking the Connections

- Before commissioning check all electrical connections for correct polarity.
- Ensure that all electrical connections are connected in accordance with the specifications of this technical description.

Always save data

Always use the SD memory card for storing data and events. In case of a failure SMA can thus help you quickly.

- Always leave the SD memory card plugged in the Sunny Island.
- Plug the SD memory card into the card reader in the PC in order to read off the data and events.

The Quick Configuration Guide (QCG) allows you to quickly and easily commission your stand-alone grid power system. To do so, use the menu to select the 'suitable' system for you. The display then shows special queries via which the system parameters can be set specifically.

8.2 Starting the Quick Configuration Guide (QCG)

Error occurrence

If the Sunny Island displays an error message, this must be remedied before the Sunny Island is commissioned (see Section 20 "Troubleshooting", page 204).

Default settings of parameters

Upon starting the QCG, viable parameter values are set by default.

The QCG is automatically activated during the initial start-up of the Sunny Island. In this case begin with point 3. If the QCG is not activated automatically, begin with point 1.

1. Switch the DC circuit breaker of the Sunny Island to "ON".

- The Sunny Island initiates the start-up phase. The notifications shown here are displayed. The last notification is displayed as soon as the start-up phase is completed.

```
SIBF5SBOOT V1.005
```

```
SMA SMA SMA SMA
SMA SMA SMA
```

```
SI6048U
@SMA 2014
```

```
To init system
hold <Enter>
```

2. Press and hold down <ENTER> until the Sunny Island beeps three times.

- The QCG is started.

```
01#StartMenu
Start System
```

i Systems with several Sunny Island inverters

If you have a system with more than one Sunny Island, you must take the following measures:

- Configure the Sunny Island with the latest firmware version as master or install the latest firmware version in the master (see www.SMA-America.com). The master updates the firmware of the slaves once the off-grid system is started.
 - You must **first run the QCG on the slave(s)** before starting the master device (display message "INIT MASTER OK START?"). Only the device type is set there. **Only start the master device thereafter!**
 - **"Start System"** (if you have accidentally accessed the QCG and would only like to restart the system)
 - **"New System"** (if you would like to start a new system or perform changes to the plant configuration)
 - **"New Battery"** (if you wish to reset battery-specific parameters only) You cannot change general parameters using "New Battery".
 - **"Emerg Charge"** (if you would like to charge a deeply discharged battery using an external source)
3. The following parameters must be set when **"New Battery"** is selected:
- Device type (master, slave 1, slave 2, slave 3)

i Systems with one Sunny Island

If only one Sunny Island is used in the system, the device type is permanently set to "master" and is not displayed.

- System configuration (see table for setting options)

Displayed text	Description
3Phase	Three-phase system, 3 Sunny Island
1Phase1	Single-phase system, 1 Sunny Island
1Phase2	Single-phase system, 2 Sunny Island
1Phase3	Single-phase system, 3 Sunny Island
2Phase2	Split-phase system, 2 Sunny Island
2Phase4	Double split-phase system, 4 Sunny Island
MC-Box	Setting for Multicluster operation

- Date/time
- Battery type (VRLA, FLA, NiCd, Lilon_Ext-BMS), default setting: "VRLA"

i Battery types

VRLA: Valve Regulated Lead Acid

Valve-regulated lead-acid batteries with immobilized electrolyte in gel or AGM (**A**bsorbent **G**lass **M**at Separator) in all standard designs available on the market (grid plate, tubular plate, small, large, AGM, gel, etc.)

FLA: Flooded Lead Acid

Flooded lead-acid batteries with liquid electrolyte in all standard designs available on the market (grid plate, tubular plate, small, large, etc.)

NiCd: Nickel Cadmium

Sealed pocket-type plate or fiber plate nickel-cadmium batteries.

Lilon_Ext-BMS: Lithium-ions with external battery management system

Closed lithium-ion battery with external battery management system.

- For FLA and VRLA: Nominal voltage of the battery 42 V to 52 V adjustable in 2 V steps; default setting: 48 V. For NiCd: Nominal voltage of the battery 43.2 V to 48 V adjustable in 1.2 V steps; default setting: 45.6 V. For Lilon_Ext-BMS: no battery voltage adjustable.
- Nominal battery capacity:
 - for lead-acid batteries (100 Ah to 10,000 Ah), default setting: "100 Ah"
 - for NiCd batteries (100 Ah to 10,000 Ah), default setting: "100 Ah"
 - for lithium-ion batteries (50 Ah to 10,000 Ah), default setting: "100 Ah"
- External voltage source (PvOnly, Gen, Grid, GenGrid)

Value in variable	Explanation
PvOnly	Stand-alone grid, no utility grid, no generator
Gen	Stand-alone grid with generator
Grid	Battery-backup grid
GenGrid	Battery-backup grid with generator

GenGrid:

- Maximum generator current (0 A to 224 A), default setting: "30 A"
- Generator interface (Manual, Autostart), default setting: "Autostart"
- Maximum grid current (0 A to 224 A), default setting: "30 A"

Grid:

- Maximum grid current (0 A to 224 A), default setting: "30 A"

Gen:

- Maximum generator current (0 A to 224 A), default setting: "30 A"
- Generator interface (Manual, GenMan, Autostart), default setting: "Autostart"

4. The following parameters must be set when "**New Battery**" is selected:

- Battery type (VRLA, FLA, NiCd), default setting: "VRLA"
- Nominal voltage of the battery (42 V to 52 V in 2 V steps for FLA and VRLA, 43.2 V to 48 V in 1.2 V steps for NiCd), default setting: "48.0 V"
- Nominal capacity of the battery (100 Ah to 10,000 Ah for VRLA, FLA and NiCd, 50 Ah to 10,000 Ah for Lilon_Ext-BMS), default setting: "100 Ah"

- After entering all parameters, the following notification appears.



5. Press <ENTER> to confirm.

- The notification shown here is displayed.



6. Press <ENTER> and hold until you hear an acoustic signal.

- The Sunny Island has started and is in operation.

i Adjustable Parameters

Observe the information on the possible settings of the parameters (see Section 19 "Parameter Lists", page 158).

Note that some parameters can only be changed after entering the installer password (see Section 10.5 "Entering the Installer Password", page 88) and in standby mode (see Section 9.2 "Stopping the Sunny Island (Standby)", page 76).

8.3 Commissioning the battery current sensor

In the event you have installed a battery current sensor in your system, you are required to synchronize the internal offset of the device. To do this, proceed as follows:

1. Set the Sunny Island to standby mode (see Section 9.2 "Stopping the Sunny Island (Standby)", page 76).

NOTICE

Entering incorrect parameters endangers operational safety. Damage to the off-grid system and its components

All parameter settings which could affect the operating safety of the off-grid system are protected by the installer password.

- Only trained electrically qualified persons are permitted to set and adjust system parameters.

2. Short-circuit the battery current sensor conductors.
 - BatCur+ to terminal 1
 - BatCur- to terminal 1

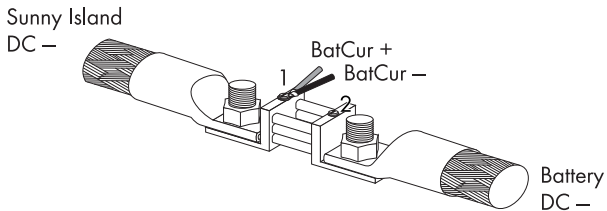

3. Enter the installer password (see Section 10.5 "Entering the Installer Password", page 88).
4. Set the following parameters:

Choose the type of battery current sensor:

- "225.01 BatCurSnsTyp" (None/50 mV/60 mV). Only after activation of the parameter with 50 mV or 60 mV, other parameters (02, 03 and 04 in the menu "225# Battery Current Sensor") will be shown and activated.
5. Set the nominal current of the battery current sensor (e.g. 400 A/60 mV):
 - "225.02 BatCurGain60": (for a 60 mV output)
 - "225.03 BatCurGain50": (for a 50 mV output)
 6. Start automatic calibration:
 - Set "225.04 BatCurAutoCal" to "Start".
 - The Sunny Island conducts an automatic calibration.
 7. Check the offset error:

Display value "120.06 TotBatCur" should be (close to) zero.

8. Reconnect the conductors of the battery current sensor correctly as displayed in the graphic. Make sure the insulated conductors have the correct polarity.
- BatCur+ to terminal 1
 - BatCur- to terminal 2

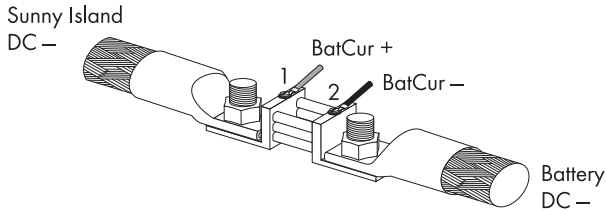

9. Start the Sunny Island (see Section 9.1 "Switching On", page 75).
10. Check the current direction: "120.06 TotBatCur"

i **Current direction: Discharging the battery**

- No generator/utility grid connected
- Loads are being supplied

The measured value of the battery current is positive.

i **Current direction: Charging the battery**

- Generator/utility grid connected
- Loads are not/marginally supplied
- Battery is being charged

The measured value of the battery current is negative.

9 Switching On and Off

9.1 Switching On

i Systems with several Sunny Island inverters

Switch on the slaves **before** you switch on the master. To do this, proceed as follows.

1. Check the following requirements:
 - correct electrical connections
 - voltages and polarities
2. Switch the DC circuit breaker of the Sunny Island to "ON".
 - The display light of the Sunny Island switches on.

i Parameter "250.01 AutoStr"

Even with the parameter "250.01 AutoStr" set, the Sunny Island must be manually started after each time the device is switched on using the DC circuit breaker.

- The Sunny Island initiates the start-up phase.
The notifications shown here are displayed.
The last notification is displayed as soon as the start-up phase is completed.

```
SIBFSBOOT V1.005
```

```
SMA SMA SMA SMA
SMA SMA SMA
```

```
SI6048U
@SMA 2014
```

```
To init system
hold <Enter>
```

3. To change settings in the QCG, manually start the QCG.
(Press and hold down <ENTER> until the Sunny Island beeps three times.)

- The QCG is started and the notification displayed here is shown.

or Wait five seconds.

- The Sunny Island skips the QCG and the notification shown here is displayed.

```
@1#StartMenu
Start System
```

```
STNDBY: To Start
INV hold <ENTER>
```

3. Disconnect the Sunny Island from the voltage sources (AC1 and AC2). Separate AC1 and AC2 and disconnect from voltage sources.
 - If PV inverters are connected to AC1, they automatically switch off once they are no longer connected to the stand-alone grid.
4. Check that the Sunny Island has been disconnected from voltage sources.
5. Wait at least 15 minutes to let the capacitors discharge and to allow the voltage inside the Sunny Island to drop to a safe level.
 - The Sunny Island is free of voltage.

9.5 Recommissioning After Automatic Shutdown

A complete shutdown indicates that off-grid system devices have failed or are not working correctly due to incorrect parameter settings. Check the off-grid system for possible faults, both before and after recommissioning to avoid a complete shutdown in the future.

NOTICE

Damage to the Sunny Island and connected devices

- Disconnect the loads only.
- Do not disconnect generators.
- Install an external load-shedding contactor if the Sunny Island is coupled to PV arrays or wind generators on the AC-generating side.

To recommission the Sunny Island after it has switched off due to a battery being too deeply discharged, proceed as follows:

1. Switch the DC circuit breaker of the Sunny Island to "OFF".

DANGER

Danger to life due to high voltages in the Sunny Island Death or serious injury possible due to electric shock

After an automatic disconnection, high residual voltages can remain in the Sunny Island capacitors.

- Wait at least 15 minutes before restarting the Sunny Island. The capacitors in the Sunny Island discharge during this time.

2. Wait at least 15 minutes.
3. Switch the DC circuit breaker of the Sunny Island to "ON".
 - The display light of the Sunny Island switches on.



Switching on the DC circuit breaker

If, in rare cases, the device cannot be switched back on after 15 minutes, wait 30 minutes and try again.

4. Switch on the Sunny Island as described in section (see Section 9.1 "Switching On", page 75).



Charging the batteries

After recommissioning, it is important that the batteries are charged. If an autostart generator is present in the stand-alone grid, the Sunny Island will request the generator after a few minutes.

5. Monitor the generator startup and check that the Sunny Island switches to charge mode.
6. Check for error-free functioning of all other energy generators in the system.



Battery-preservation mode after recommissioning

If, after recommissioning, the Sunny Island immediately switches into battery-preservation mode (see Section 13.6 "Battery-Preservation Mode", page 115), disconnect all loads from the AC output.

The loads can be reconnected once the Sunny Island enters the state of charge. A precondition for this is that a generator capable of providing the required power is connected (see Section 20.10 "Procedure during Emergency Charge Mode", page 223).

10 Operation

The main menu consists of a "Home Screen" and the other main menu entries, which split up into the different menu levels. Operating states, e.g. the current operating mode, power, etc. are displayed on the "Home Screen" (see Section 10.6 "Display Messages (Overview)", page 89).

The menu consists of a main menu and maximum two sub-menu levels (see Section 10.1 "Menu Structure", page 80).

Use the up and down arrow buttons to navigate through the menu levels. The cyclical arrangement (wrap around) allows you to scroll both forward and backwards to access the desired menu as quickly as possible.

i Faster access to menus

If you want to access sub-menu "7", go back from step "1" to step "9" instead of going six steps forwards.

When the desired menu is reached press the <ENTER> key in order to access it. The <ESC> key exits the menu and puts you one menu level up.

i Switching to the "Home Screen" in case of inactivity

If no button is actuated for more than five minutes (inactivity), the "Home Screen" appears.

i Backlight

The display backlight is automatically deactivated after a short time of inactivity. You can switch the backlight back on by pressing one of the four buttons. No settings are changed when you press the button, this only activates the display illumination.

i Button sound

The button sound is switched on by default. In order to deactivate it, set the parameter "250.04 BeepEna" to Off. If "250.04 BeepEna" is set to "Off", the Sunny Island does not emit an acoustic signal in the event of disturbances and errors.

i Slaves wait for commands from the master

Slave devices must wait for commands from the master device. The following message is shown in the display during this time.



```
Ready
Wait for Master
```

The Sunny Island uses an operating concept referred to as "**Single Point of Operation**". For a system with more than one Sunny Island, all entries are made on the master. There, you configure the entire system, confirm events, warnings and errors in the QCG (see Section 8 "Commissioning", page 69), and perform firmware updates when required (see Section 11.6 "Firmware Update", page 100).

Exception: When starting the device for the first time, you must set the slave devices as slave in the QCG and everything else is performed from the master.



Single Point of Operation

Single Point of Operation also means that all log data of the master including the log data of the slaves are saved to the SD memory card on the master.



Messages

Messages can be displayed at any time while the device is in operation and they have priority over the "Home Screen" display.

10.1 Menu Structure

The navigation area includes the "Home Screen" and the main menu items:

- 100# Meters (display values)
- 200# Settings
- 300# Diagnosis
- 400# Failure/Event (lists)
- 500# Operation (operating functions)
- 600# Direct Access

The main menu is divided into several sub-menus.

In a sub-menu, you can select a second sub-menu or a parameter.

NOTICE

Entering incorrect parameters endangers operational safety. Damage to the off-grid system and its components

All parameter settings which could affect the operating safety of the off-grid system are protected by the installer password.

The menu items and parameters in which system parameters can be changed are accessible after entering the installer password (see Section 10.5 "Entering the Installer Password", page 88).

- Only trained electrically qualified persons are permitted to set and adjust system parameters.

You can access the navigation area from one of two levels:

- User level
- Installer level (password required)

Overview of the Menu Structure:

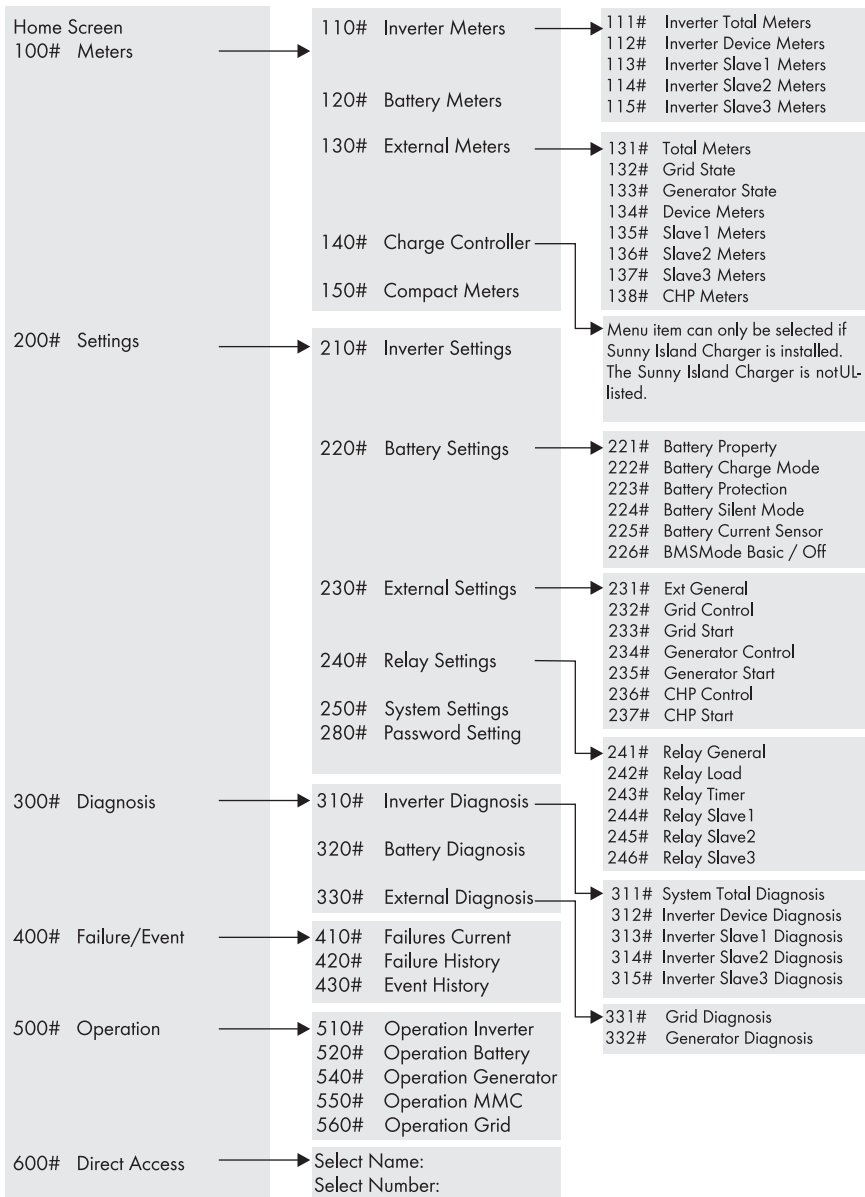

100# Meters - Display values

In this main menu, you will find the display values for the following devices of the off-grid system:

- 110# Inverter Meters – Sunny Island
- 120# Battery Meters – Battery
- 130# External Meters – Utility grid/Generator
- 140# Charge Controller – Sunny Island Charger (is only shown when there is at least one Sunny Island Charger connected to the Sunny Island)
- 150# Compact Meters – compact view of values for commissioning

By opening the relevant sub-menu - if necessary, the second sub-menu - you can view the parameters (e.g., Parameter "112.03 InvVtg").

200# Settings

The following sub-menus allow you to view and adjust the system parameters:

- 210# Inverter Settings – Sunny Island
- 220# Battery Settings – Battery
- 230# External Settings – Utility Grid/Generator
- 240# Relay Settings – Relays
- 250# System Settings – System
- 280# Password Setting – Password entry

300# Diagnosis

The following sub-menus allow you to view system data:

- 310# Inverter Diagnosis – Sunny Island
- 320# Battery Diagnosis – Battery
- 330# External Diagnosis – Utility Grid/Generator

400# Failure/Event - Failures and Events

You can view various error and event lists in the following sub-menus:

- 410# Failures Current – Current failures
- 420# Failure History – Previous warnings and failures
- 430# Event History – Previous events

500# Operation - Functions during operation

The following sub-menus allow you to view and adjust operating parameters:

- 510# Operation Inverter – Sunny Island
- 520# Operation Battery – Battery
- 540# Operation Generator – Generator
- 550# Operation MMC – SD Memory Card
- 560# Operation Grid – Utility grid

600# Direct Access – Direct access to the parameters

This is a main menu that gives you direct access to the settings and display values (see Section 10.3 "Direct Access - Direct Access to the Parameters", page 84).

10.2 Changing Parameters

Using the up and down arrow buttons, you navigate through a selected menu to view or change a parameter, for example. When the relevant parameter is displayed, you can read off its present value.

An arrow next to the value indicates that the parameter can be changed.

If you press <ENTER>, the arrow begins to blink and you can use the up and down arrow buttons to change the value of the parameter "221.02 BatCpyNom".

i Increments (speed)

The increment size (speed) of the change increases if you hold the button pressed down.

As soon as the desired value appears on the display, press <ENTER> to save the new value.

Then select Y(es) or N(o) by pressing the up/down arrow buttons to accept or reject the changes.

Press <ENTER> again in order to finish the process and continue with other modifications.

i Changing parameters

Note that some parameters can only be changed when the device is in standby mode (see Section 19.2 "Adjustable Parameters", page 167). All menu items that can only be changed by the installer using a password are shaded in gray in the parameter list.

The Sunny Island displays a corresponding message for parameters that can only be changed in standby mode or require a different password level.

Display	Description
	<p>Incorrect password level, you cannot make any changes in the menus (see Section 10.5 "Entering the Installer Password", page 88).</p> <p>All menu items and parameters that can only be changed by the installer are shaded in gray in the parameter list (see Section 19 "Parameter Lists", page 158).</p>
	<p>This parameter can only be changed in standby mode. Stop the Sunny Island to change the parameter (see Section 9.2 "Stopping the Sunny Island (Standby)", page 76).</p>

10.3 Direct Access - Direct Access to the Parameters

The "600# Direct Access" menu gives you direct access to the selected parameter using the parameter name or number.

Via the Select Name sub-menu, you have direct access to the following functions:

- GnManStr: manual starting of the generator (see Section 14.1.4 "Manual Generator Operation", page 122)
- ManChrgSel: manual starting of equalization charge (see Section 13.5.3 "Equalization Charge", page 114)

Via the Select Number menu, you have direct access to every parameter by entering the parameter number.

Example

Using the menu 600# Direct Access, you can select the parameter "222.01 BatChrgCurMax", e.g. to set the maximum battery charging current.

The direct access must be entered as a five-digit number, for example 22201. Here, the first three digits describe the menu number and the last two describe the parameter number.

Exit the menu level after the parameter has been set.

10.4 Compact Meters

The "150# Compact Meters" menu is intended primarily to help the installer commission the device. The display gives you information at a glance on the following areas:

- Battery 1
- Battery 2
- Inverter (AC values)
- InvTot
- Utility grid/Generator (External)
- ExtTot
- Inverter status

Selecting the area

You can select the different displays of the compact meters using the up/down arrow buttons. Here, you can also use the "Wrap around" function.

The displays are always shown from the upper left to the lower right.

Bat1 (Battery values 1)

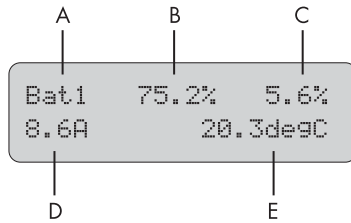

Position	Description
A	Name of the compact meter
B	Present battery state of charge (BatSoc)
C	Estimated error of the state of charge (BatSocErr)
D	Total battery current of the cluster (TotBatCur)
E	Battery temperature (BatTmp)

Bat2 (Battery values 2)

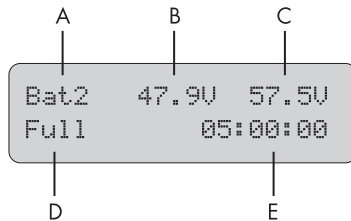

Position	Description
A	Name of the compact meter
B	Battery voltage (BatVtg)
C	Setpoint of charging voltage (BatChrgVtg)
D	Active charging process (BatChrgOp)
E	Remaining absorption time (ApfTmRmg)

Inv (AC Values of Inverter)

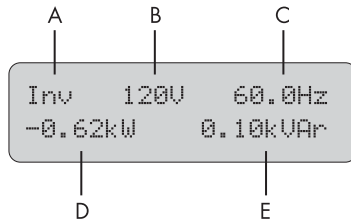

Position	Description
A	Name of the compact meter
B	Present voltage at the inverter (InvVtg)
C	Present frequency at the inverter (InvFrq)
D	Present active power of the inverter (InvPwrAt)
E	Present reactive power at the inverter (InvPwrPt)

InvTot (Total AC Values of Inverter)

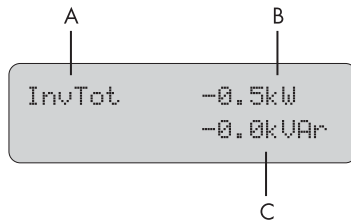

Position	Description
A	Name of the compact meter
B	Total active power of the inverter (cluster)
C	Total reactive power of the inverter (cluster)

Ext (AC Values of External Source)

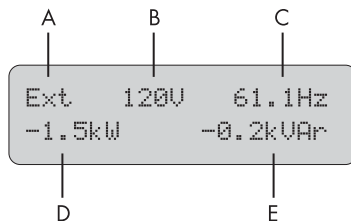

Position	Description
A	Name of the compact meter
B	Voltage of the external source (ExtVtg)
C	Frequency of the external source (ExtFrq)
D	Active power of the external source (ExtPwrAt)
E	Reactive power of the external source (ExtPwrPt)

ExtTot (Total AC Values of External Source)

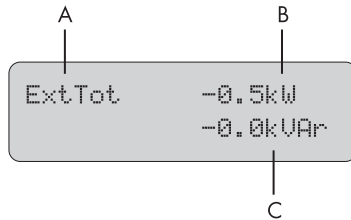

Position	Description
A	Name of the compact meter
B	Total active power of the external source (cluster)
C	Total reactive power of the external source (cluster)

OpStt (Inverter and Generator Status)

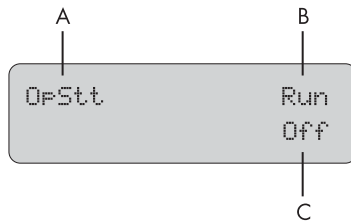

Position	Description
A	Name of the compact meter
B	Operating state of the inverter (InvOpStt)
C	State of the generator (GnStt)

10.5 Entering the Installer Password

NOTICE

Entering incorrect parameters endangers operational safety. Damage to the off-grid system and its components

All parameter settings which could affect the operating safety of the off-grid system are protected by the installer password.

- Only trained electrically qualified persons are permitted to set and adjust system parameters.

i Do not disclose the password to unauthorized persons

Do not provide the following information for entering the installer password to unauthorized persons. Illegal provision of this information to other persons will lead to the invalidation of all SMA warranty provisions.

i Entering the password

The Sunny Island allows you to enter the password not only in standby, but also during operation.

The password is dependent on the operating hours counter. In the installer level, there are extended access privileges to all necessary parameters.

Password = checksum of the operating hours

Proceed as follows to enter the installer password of the "Home Screen":

1. Keep pressing the "arrow down" key until the "200# Settings" menu is displayed.
2. Press <ENTER>.
3. Keep pressing the "arrow up" key until the "280# Password Setting" menu is displayed.
4. Press <ENTER>.
 - The "280# Password Setting" sub-menu opens.
5. Press <ENTER>.
6. Determine the password. Calculate the checksum (sum of all digits) of the operating hours. In the message shown here:

$$1 + 2 + 3 + 4 + 5 + 6 = 21$$
7. Enter the password by pressing the up/down arrow buttons.

```
200# Settings
```

```
280# Password
Setting
```

```
PW:** Level[0]
OnTmh 123456 h
```

```
PW:** Level[0]
OnTmh 123456 h
```

8. Confirm the password by pressing <ENTER>.

- ☑ The installer password has been entered.
Operating level [1] = the installer level is set.



9. Exit the menu by pressing the <ESC> key.

i **Switching operating levels**

- If the password is invalid, the Sunny Island does **not** switch to the installer level. In this case, recalculate and re-enter the installer password as described in this section.

The installer level is switched back to the user level if:

- the Sunny Island is switched off and on again.
- specific parameters are entered (e.g. parameter "510.01 InvRs") that cause a restart.
- an incorrect password is entered.
- no activity takes place within five minutes.

10.6 Display Messages (Overview)

The display has two lines, each with 16 characters. The first line shows the menu number and the menu name, or the name of the parameter where applicable. In the lower line - if required - the name of the menu is added or additional text is displayed (for example the parameter value).

"Home Screen"

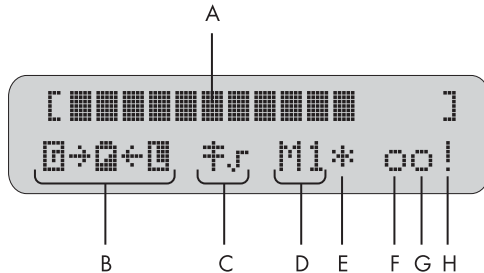

Position	Description
A	Output power/charging power (load status)
B	Direction of energy flow and system status
C	Displays if the Sunny Island loaded parameters for grid operation or parameters for generator operation.
D	Device assignment
E	Status of the external source (asterisk, question mark or exclamation mark)
F	Relay 1 status

Position	Description
G	Relay 2 status
H	Warning message (exclamation mark)

The Sunny Island also shows the following values one after the other in the upper line of the "Home Screen" (parameter name and parameter value in 3-second intervals):

- Bar display for output power or charging power (the direction of energy flow is displayed by the arrows in the lower line)
- Total active power of the inverter (cluster)
- Active power of external source (total of all phases)
- Present state of charge of the battery (SOC)
- Meters (always one of five possibilities, depending on priority)
 - Remaining absorption time
 - Remaining generator warm-up time
 - Remaining Run 1 h time for the generator
 - Remaining time of Timer 1
 - Remaining time of Timer 2
- Active charging process





Situational displaying of text and values















The display shows only values that are relevant in the actual system status. If there is no generator connected, no generator values are displayed





Messages on the slave devices

On the slave devices, the upper line of the display shows the bar graph for output power or charging power. The lower line of the display shows the device assignment (e.g. S1 for slave 1) and, where applicable, the status of external sources (*, for a description, see further above) and the status of relays.

Meaning of the Symbols that appear in the "Home Screen":

Symbol	Meaning
	Nominal power
	Nominal load exceeded.
	Direction of energy flow between grid/generator side, battery and load side.
	Generation side (Generator/Grid) is on.

Symbol	Meaning
	Battery
	Load side (Loads/Sunny Boys)
	Utility pole
	The Sunny Island is working with grid limits.
	The Sunny Island is working with generator limits.
	The Sunny Island is configured as master.
	The Sunny Island is configured as slave 1.
	The Sunny Island is configured as slave 2.
	Status of the external source: Voltage and frequency of the generator/the utility grid are within the configured limits.
	Status of the external source: Voltage and frequency of the external source are not within set limits. In this case, the Sunny Island does not connect the generator to the stand-alone grid.
	Status of the external source (at position (E) on the display): The maximal admissible generator reverse power was exceeded and the Sunny Island has disconnected the generator from the stand-alone grid.
	"Battery" request reason: The generator has been requested as a result of the battery state of charge.
	"Cycle" request reason: The generator was requested via the time-dependent repetition cycle of the generator operation (parameter: 235.17 GnTmOpCyc).
	This symbol can only be shown in Multicluster operation. "External" request reason: The generator was requested via the extension cluster. This request can only take place in multicluster operation.
	"Load" request reason: The generator has been requested as a result of the load-dependent generator request.

Symbol	Meaning
	"Start" request reason: The generator has been requested by the operator manually setting the generator request in the Sunny Island from "Auto" to "Start". The generator is then no longer automatically controlled or switched off by the Sunny Island.
	"Time" request reason: The generator was started for one hour using the "Run 1h" setting in the Sunny Island. Once this time has passed, the Sunny Island automatically switches off the generator.
	Display for relay (solid circle = relay is activated; empty circle = relay is deactivated)
	Warning message is displayed (at position (H)): This symbol blinks until you have confirmed the warning or the error in the menu "410# Failures Current" or "420# Failure History".

Display "Generator Status" and "Request Reason"

The two displays above are cyclically shown on the display as the status of the external source.

Example:

If the display changes every three seconds from "*" to "B", this means that the generator voltage and frequency are within the set limits and that the generator was requested as a result of the battery state of charge.

Stopping the generator manually

If the generator has been manually stopped, no generator status information is displayed. The field remains empty in this case.

Indications of a warning

If faults occur, the device switches into standby mode and shows the fault on the display. The fault must be eliminated and confirmed, then the Sunny Island carries out an autostart.

10.7 Parameter Display

Parameters on the Sunny Island are displayed as follows:

In the upper line, the parameter number comes first, then a separator (hash) followed by the parameter name. In the lower line, there is the value with the unit and the modification mark (enter arrow) is on the far right.

```
02#AptTmBoost
120 min ↵
```

Parameter/value list

If you would like to switch from a menu (regardless of whether it is a main or sub-menu) into a parameter/value list, the menu numbers are not included on the display.

i Syntax for menus and parameters

The syntax specified here for menus and parameters applies throughout the entire document.

A menu is designated by the number of the menu, hash and the name of the menu (120# Battery Meters).

A parameter is labeled with the menu number, dot, the parameter number and parameter name (120.02 BatVtg).

10.8 Display of Events

The Sunny Island can display a list of events:

The serial number (quantity) of the event is displayed in the upper line. Display of time and date and time changes in two-second intervals. In the lower line are the number of the event and the corresponding short text.

```
001 11:55:01
E108 -----
```

```
001 10.08.2009
Silent
```

10.9 Display of Warnings and Failures

The Sunny Island can display a list of errors and warnings:

The consecutive number (quantity) of the error is on the upper line; the time and date display changes in two-second intervals. On the lower line are the number of the error and the corresponding error short text.

```
001 11:55:01 C
F208 Warning
```

A "!" on the right on the upper line indicates when the warning and/or error occurred.

A "C" on the right on the upper line indicates when the warning or the error was confirmed or cleared.

i Direct access to the error list

As a shortcut, press ESC and the arrow up button simultaneously to go directly to the error list (#420 Failure History).

11 Data Storage on SD Memory Card

The Sunny Island can store firmware, parameters and measured data on a SD memory card which must be FAT-16-formatted and may have a max. size of 2 GB (possible storage sizes are 32/64/128/256/512 MB and 1 GB and 2 GB). Use the supplied SD memory card only for the Sunny Island. Do not save any multimedia files on the SD memory card.

File names are saved in 8.3 format and files with other designations are ignored.

i Example of a format

A valid 8.3 format is, for example, "M1111LOG.DAT".

8.3 is the "old" MS-DOS format with a file name that has a maximum of eight figures before and three figures after the dot.

i Type of memory card

SMA recommends the use of a Transcend SD memory card.

If you use a memory card from another manufacturer, check whether the card is FAT-16 formatted. If necessary, format the card. Be aware that data stored on the card will be lost.

i Using memory cards in the off-grid system

If you combine the Sunny Island inverters in one off-grid system, use one SD memory card always only for one type of Sunny Island (SI 4548-US-10 / 5048U / 6048-US-10). This will ensure optimum functioning of the off-grid system.

- Make a note of the type of the Sunny Island used on the SD memory card after the first data recording.
- Only insert this SD memory card into this type of Sunny Island.

Once you have inserted the SD memory card in the slot on your PC, you can search the corresponding drive in your Explorer (example here: Microsoft Windows). The following data is present on this drive (here E:):

Name	Size	Type	Date Modified
smst.dat	5 KB	SMS File	12/1/2009 10:00 PM
smst.dat.txt	3 KB	Text Document	12/1/2009 10:00 PM
s011209.evnt	10 KB	EVY File	12/1/2009 12:00 AM
s011209.log	1,005 KB	Text Document	12/1/2009 12:00 AM
s051109.evnt	10 KB	EVY File	11/5/2009 7:06 AM
s051109.log	1,005 KB	Text Document	11/5/2009 7:06 AM
s031109-evnt	10 KB	EVY File	11/2/2009 12:00 AM
s031109.log	1,005 KB	Text Document	11/2/2009 12:00 AM
s041109.evnt	10 KB	EVY File	11/2/2009 12:00 AM
s041109.log	1,005 KB	Text Document	11/2/2009 12:00 AM
s051109-evnt	10 KB	EVY File	11/2/2009 12:00 AM
s051109.log	1,005 KB	Text Document	11/2/2009 12:00 AM
spbar.lst	30 KB	LST File	11/5/2009 7:06 AM
spbar.lst	30 KB	LST File	11/5/2009 7:06 AM
spbar.lst	30 KB	LST File	12/2/2009 12:00 AM
update.bin	736 KB	BIN File	11/4/2009 1:12 PM

The files on the SD memory card have the following meanings:

File name	Meaning
evthism.log (evthisN.log for SlaveN)	Event history of the device, saved by means of parameter "550.03 CardFunc", option StoEvtHis
failhism.log (failhisN.log for SlaveN)	Failure history of the device, saved by means of parameter "550.03 CardFunc", option StoFailHis
si030607.evt	Event/failure history for the day (Format MMDDYY)
si030607.log	Data logging for the day (Format MMDDYY)
sipar1.lst	Parameter list of the device, created by means of parameter "550.01 ParaSto", option Set1
sipar2.lst	Parameter list of the device, created by means of parameter "550.01 ParaSto", option Set2
sipar.lst	This file is saved after changing a parameter.
update.bin	Software for the device
batstat.txt	Statistical values of the battery. These values are saved every day at 10:00 p.m.
batstat.sma	Internal data from SMA
si.ccf	System information from Sunny Island.

"BOOTEX.LOG" File

The file "BOOTEX.LOG" is not necessarily contained on the card, it will be created depending on the operating system used (e.g. Windows XP or Windows 2000).

The firmware of the Sunny Island expects device-specific data in the main directory of the SD memory card. This data includes a new firmware, parameters and measuring data.

The Sunny Island uses the SD memory card to save and load device parameters.

The Sunny Island still records the measuring data on the SD memory card. It saves this data in a special file. This contains, among other things, a header, time stamp, date and data type. There are two different types of log data:

- Measurement data (are saved cyclically)
- Events and errors (are only saved when they occur)

The Sunny Island supports the acquisition of measurement data with data from the fields:

- Battery
- Inverter
- System
- External source
- Loads

i Always save data

Always use the SD memory card for storing data and events. In case of a failure SMA can thus help you quickly.

1. In the event of a fault contact the SMA Service Line.
2. Upon agreement with the SMA Service Line, save all data from the SD memory card into one folder and compress this (e.g. as ZIP file).
3. Send the compressed data via e-mail to the SMA Service Line.

The data saved on the SD memory card can be processed using common spreadsheet programs.

- The first 13 lines of the file are used for information (file header).
- The following data is separated by semicolons.
- Decimal places are separated by periods.
- The date format is MM/DD/YYYY
- The time format is hh:mm.

i Log Data

For additional information on processing the log data, please refer to the manual of the data processing software you use.

11.1 Inserting the SD Memory Card

NOTICE

Electrostatic discharge when inserting the SD memory card Electrostatic discharge can damage the Sunny Island components

- Ground yourself before inserting or removing the SD memory card at the Sunny Island enclosure.

Insert the SD memory card with the cut corner pointing down into the slot on the Sunny Island (see illustration).

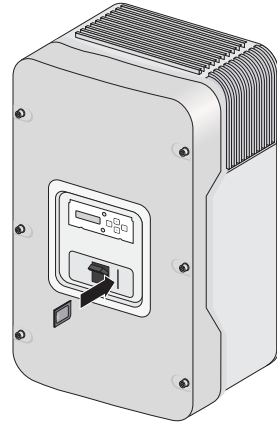

After inserting the SD memory card into the Sunny Island, the adjacent message appears on the display prohibiting the removal of the card:

```
Do not remove
MMC/SD card ...
```

Initializing the SD memory card may take a few minutes. During this time, the buttons are disabled and cannot be used for making entries, and three points appear in the lower line of the display.

If the procedure was successful, the graphic shown here is displayed.

```
MMC operation
finished
```

- The Sunny Island initializes the SD memory card and writes a file "Sipar1.lst" to the SD memory card.

In case of a fault, the following message appears:

```
MMC operation
!!!failed!!!
```

11.2 Removing the SD Memory Card

To ensure that all log data is saved upon deactivation, write all data not yet saved from the buffer to the SD memory card by using the parameter "550.03 CardFunc" with the option "ForcedWrite".

i Data loss

If you remove the SD memory card without first activating the parameter "550.03 CardFunc", you lose up to a maximum of 15 minutes of data.

11.3 Saving and Loading Parameters

You can configure and use various settings with various parameters, this means winter and summer. This parameter sets are known as Set 1 and Set 2. Using the parameter "550.01 ParaSto", you can save the current parameter settings and using the parameter "550.02 ParaLod", you can load the saved parameters.

i Save settings

If the system is working optimally, it is a good idea to save these settings. This is especially useful if you try out new settings and then wish to reset the inverter back to the previous settings.

When saving the parameters, you have the following options:

- Set1 (save parameter set 1)
- Set2 (save parameter set 2)

When loading the parameters, you have the following options:

- Set1 (load parameter set 1)
- Set2 (load parameter set 2)
- Factory (load the default settings (reset))

i Write protection function of SD memory cards

The write protection function of SD cards (plastic sliding clip on the left side) is not supported by the Sunny Island. You should take note of this when writing data to your card.

11.4 Writing Log Data

Using the parameter "550.04 DatLogEna", you can activate the function for writing log data to your SD memory card (activated by default).

If the Sunny Island is writing data to the SD memory card, removing the card is prohibited and the following message appears on the display:

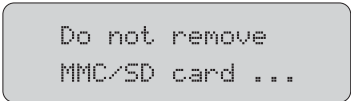

Do not remove
MMC/SD card ...

11.5 Status Messages

Using the parameter 312.07 CardStt", you can query the status of your SD memory card:

Display	Description
07# CardStt Off	The SD memory card is deactivated.
07# CardStt Operational	The SD memory card is activated.
07# CardStt Out of Space	The SD memory card is full.
07# CardStt Bad File Sys	The SD memory card has an invalid file format.
07# CardStt INCOMP	The SD memory card is incompatible.
07# CardStt Parameter	The Sunny Island is loading parameters from the SD memory card.
07# CardStt Param Failed	Loading parameters from the SD memory card has failed.
07# CardStt Mount	The SD memory card is being accessed.
07# CardStt Write Log Data	The Sunny Island is writing log data to the SD memory card.

11.6 Firmware Update

The firmware of the Sunny Island can be updated via the SD memory card. Upon startup or when the SD memory card is inserted, the Sunny Island searches for special update files on the SD memory card. If it finds files containing new firmware versions, it performs an update when the Sunny Island is in standby mode.

i Duration of the firmware update

The update for single-phase systems takes approximately five minutes.

For system configurations with more than one Sunny Island, the software update can take up to 20 minutes.

A status bar shows the progress of the update. Leave the SD memory card in the Sunny Island until the update is finished. During the update process, leave the DC switch to the "On" position.

Proceed as follows for a firmware update:

i Observe the following:

- You may only download firmware versions from www.SMA-America.com. Using unauthorized firmware versions cancels the warranty.
 - None of the already existing parameter settings are changed or erased during a firmware update.
 - New parameters are assumed with default values.
 - If there is an update to the firmware version greater or equal to 6.000, the battery management is automatically reset. All set parameters are lost.
 - Do not activate the DC circuit breaker during the firmware update.
 - Do not switch off the Sunny Island during the firmware update.
1. Create a backup copy of the existing parameter lists (see Section 11.3 "Saving and Loading Parameters", page 98).
 2. Download the latest firmware version from the Internet at www.SMA-America.com.
 3. Copy the "UPDATE.BIN" file to the SD memory card.
 4. Set the master device to standby.
 5. Insert the SD memory card into the slot of the master.
 - The update will be performed.

i Reset after a successful update

After the update has been successfully completed a reset is enforced in order for the changes to become effective. After the reset, the master device remains in standby mode.

6. Press and hold <ENTER>.
 - The Sunny Island starts. The update has been completed.

i Starting QCG

If you have carried out a firmware update in which the number before the dot in the firmware version has changed, it is advisable to start QCG and to perform all settings anew.

Firmware Update in a System with One Sunny Island

During the update, the Sunny Island displays the following messages.

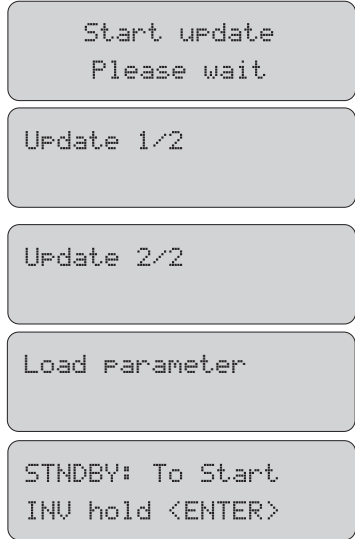

Firmware Update in a System with Several Sunny Island

In a system with several Sunny Island inverters, the firmware is only updated on the master. If the master detects that a slave has a different firmware version, it transmits its firmware to the slave and makes sure that all Sunny Island inverters within a system operate with the identical firmware version. While the master updates the slaves, the devices show the following messages, among other things. The display messages listed below may be shown at various lengths. Wait until the master displays the message "Update finished". Press Enter" and for the slaves the display message "Ready Wait for Master." Do not make any entries during the update.

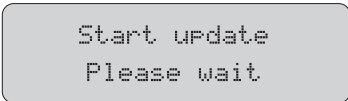
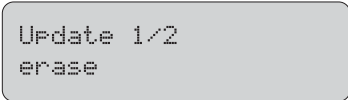
Display message	Display from	Explanation
	Master	The master update starts.
	Master	Master update part 1/2.

Display message	Display from	Explanation
<pre>Update 1/2 erase</pre>	Master	Master update part 2/2.
⋮		
<pre>Start update Please wait</pre>	Master	The slave update starts.
⋮		
<pre>Updating Slaves</pre>	Master	The slave update is running.
⋮		
<pre>Update finished Press Enter</pre>	Master	The master update is completed.
⋮		
<pre>Ready Wait for Master</pre>	Slave	The slave update is completed.

i Parameters and settings

Individual parameters and settings are retained during a firmware update.

i Switching on a slave with a different firmware version

If a slave with a different firmware version is connected, first stop the master. Stop all slaves. Then restart the master. The slaves start automatically and the master performs a firmware update.

12 Additional Functions

12.1 Load Shedding

If the loads connected to the Sunny Island consume more energy over a longer period of time than the generators connected produce, the battery can deeply discharge. The Sunny Island shuts down automatically if the state of charge of the battery is too low. This way, the Sunny Island avoids a deep discharge of the battery. Due to the automatic shutdown of the Sunny Island, the loads are not supplied with electricity and the generators connected to the Sunny Island can not charge the battery.

In off-grid systems in which generators are connected directly to the battery via DC-to-DC converters, these generators charge the battery, even if the Sunny Island automatically shuts down. When the battery reaches a particular state of charge, the Sunny Island can carry out an automatic restart after the automatic shutdown. After the automatic restart, the generators connected to the Sunny Island can also charge the battery.

You can prevent the Sunny Island from automatically shutting down by installing a power contactor for load shedding. The power contactor automatically switches off the loads in the off-grid system when the battery charge level is low. The Sunny Island continues operating and can charge the battery.

Install an external (AC or DC) power contactor between the Sunny Island and the loads (see Section 21 "Accessory", page 226).

NOTICE

Rapid battery electric discharge in the event of missing load shedding

Premature failing of the off-grid system.

- Install an external load shedding contactor as soon as the off-grid system on the AC generating side is coupled to PV arrays or wind generators.
- If there is overload due to low energy production or very high energy consumption, you must be able to switch off loads.
- Always switch off the loads, never the energy generators (e.g. Sunny Boy).

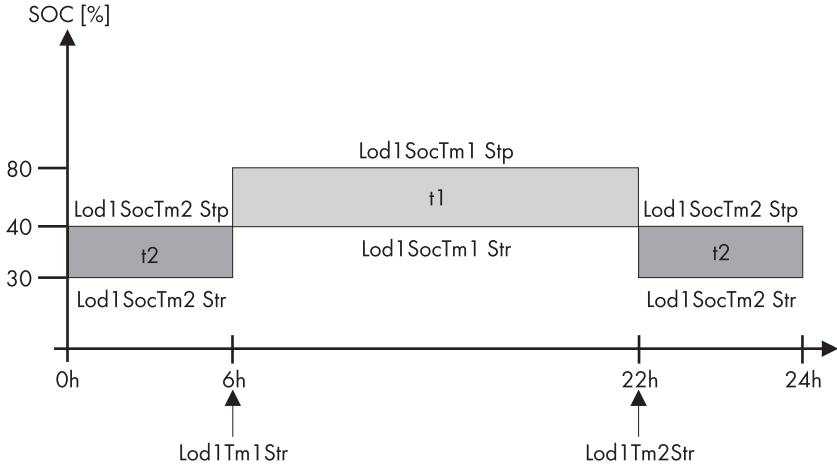

The figure shows an example of the settings if the step-by-step load shedding function at night is to be avoided as much as possible. From 6 a.m. to 10 p.m. the load shedding is activated for a state of charge (SOC) of 40%, at nighttime (from 10 p.m. to 6 a.m.), however, the state of charge of the battery is allowed to go down to 30% before the load-shedding contactor is activated.

The load shedding function can be assigned a total of two times. Thus, in the above listed parameters, the part "Lod 1" (see parameters "242.01 Lod 1 SocTm 1 Str" to "242.06 Lod 1 Tm 2 Str") represents the first assigned function. Another part "Lod 2" (see parameters "242.07 Lod 2 SocTm 1 Str" to "242.12 Lod 2 Tm 2 Str") represents a second, identical function. These two battery state-dependent load-shedding functions allow a step by step load shedding where different load groups with different SOC values can be defined with different priorities.

Define the time intervals t1 and t2:

- Starting time t1: with parameter "242.05 Lod 1 Tm 1 Str", set the start time for t1 (and with it the end of t2).
- Starting time t2: with parameter "242.06 Lod 1 Tm 2 Str", set the start time for t2 (and with it the end of t1).
- If the time intervals t1 (Lod 1 Tm 1 Str) and t2 (Lod 1 Tm 2 Str) are consistent with one another, only t1 will be activated.

Set the battery state of charge at which the time interval t1 or t2 will start/stop:

- The battery state of charge during the t1 interval, the recognition of which will lead to the load-shedding function being started: Parameter "242.01 Lod 1 SocTm 1 Str"
- The battery state of charge during the t1 interval, the recognition of which will lead to the load-shedding function being stopped: Parameter "242.02 Lod 1 SocTm 1 Stp"
- The battery state of charge during the t2 interval, the recognition of which will lead to the load-shedding function being started: Parameter "242.03 Lod 1 SocTm 2 Str"
- The battery state of charge during the t2 interval, the recognition of which will lead to the load-shedding function being stopped: Parameter "242.04 Lod 1 SocTm 2 Stp"

12.2 Sleep Mode

Using the parameter "250.10 SleepEna" set to "Enable" allows the sleep mode to be activated in single-phase utility grids which the master uses to switch off the slaves when the power value allows this.

Sleep mode

The "Sleep Mode" works exclusively in stand-alone mode. The values for connection and disconnection of the Sunny Island are already set at the factory (optimized in terms of efficiency).

12.3 Time-Controlled Operation

The Sunny Island can be operated in a time-controlled manner using a timer function (like a clock timer), supplying power at a planned point in time.

This function must be activated by using the parameter "510.02 InvTmOpEna". Using the parameter "510.03 InvTmOpStrDt", you can specify the start date, and using the parameter "510.04 InvTmOpStrTm", you specify the start time. With the parameter "510.05 InvTmOpRnDur", you set the running time and with the parameter "510.06 InvTmOpCyc", you determine whether this function will be carried out once, every day or weekly, at or from the specified start time (date and time).

12.4 Overload and Short-Circuit Behavior

The Sunny Island can be temporarily operated under overload conditions. and is able to supply short-circuit current.

In the event of overload, the Sunny Island 4548-US supplies a power of 5,300 W for 30 minutes at 77°F (25°C) and the Sunny Island 6048-US a power of 7,000 W. Both Sunny Island inverters can deliver a power of 7,200 W for 5 minutes at 77°F (25°C). The available power can even reach 8,400 W for 1 minute at 77°F (25°C).

In the event of a short circuit, the Sunny Island provides a maximum current of 180 A (for 60 ms). This is sufficient to trip commercial 20 A circuit breakers.

12.5 Mixed Operation with Sunny Island Inverters of Different Power

The Sunny Island inverters 4548-US, 6048-US and 5048U can be operated in an off-grid system together.

Each Sunny Island makes its contribution to cover the current power requirements of the loads. This contribution is made up of the ratio of the nominal power of each Sunny Island to the overall power of all Sunny Island inverters.

If an SI 5048U is installed in an off-grid system configure the SI 5048U as slave or equip with the latest firmware (see www.SMA-America.com).

Double-Split-Phase System

In a double split-phase system, each line conductor must only be fitted with Sunny Island inverters of the same type (e.g. two Sunny Island 6048-US).

12.6 Device Faults and Autostart

If a critical fault occurs, the Sunny Island automatically shuts down and displays the reason on the display. If the autostart function is activated (parameter "250.01 AutoStr") the Sunny Island can acknowledge the error automatically and restart on its own. If the error persists, the Sunny Island cannot be started.

Autostart meter

If the autostart meter has counted down to zero, the Sunny Island waits for ten minutes before attempting to restart automatically.

Displaying messages

Messages can be displayed at any time while the device is in operation and they have priority over the "Home Screen" display.

12.7 Automatic Frequency Synchronization

Clocks that depend on the stability of the power frequency for their accuracy become increasingly inaccurate when there are constant frequency deviations. Frequency fluctuations, i.e., deviations from the nominal frequency occur, for example, in off-grid systems that operate with a diesel generator.

The automatic frequency synchronization (German: AFRA) function of the Sunny Island allows the use of clocks in these types of off-grid systems. This function is activated using the parameter "250.11 AfraEna". The time deviation is compensated on average.

Quartz-controlled clock in the Sunny Island

The internal clock in the Sunny Island is quartz-controlled and thus operates correctly (within the tolerance limits). The adjustment refers to externally connected clocks that depend on the power frequency.

12.8 Time-Controlled Standby

You can set the Sunny Island to standby mode in a time-controlled way. Activate the time-controlled standby using the parameter "250.13 SlpAtNgt". Set the parameter to "Enable".

After activation, set the start time and the stop time for standby. Carry out the setting using the parameters "250.14 SlpStrTm" and "250.15 SlpStpTm".

12.9 Behavior in the Event of a Failure in a Three-Phase System

You can influence how the Sunny Island reacts to failures occurring in a three-phase system using the parameter "250.30 RnMod". The parameter is set to "RunAlways" at the factory. This means that the master ignores all errors at the slave devices.

If you set the parameter to "StopAlways", the system will be put in standby mode upon detection of a fault at the slave devices. Faults which can be removed via an autostart are not included.

13 Battery Management

13.1 Battery Type and Minimum Battery Capacity

The battery management of the Sunny Island supports the following three battery types (parameter "221.01 BatTyp"):

FLA	Flooded Lead Acid: valve-regulated lead-acid battery with liquid electrolyte in all standard designs available on the market (grid plate, tubular plate, small, large, etc.).
VRLA	Valve Regulated Lead Acid: Closed lead acid batteries with immobilized electrolyte in gel or AGM (Absorbent Glass Mat Separator) in all standard designs available on the market (grid plate, tubular plate, small, large, AGM, gel, etc.)
NiCd	Nickel Cadmium: Sealed pocket-type plate or fiber plate nickel-cadmium batteries.

Lithium-ion batteries have an own battery management. The battery management of the lithium-ion battery communicates with the Sunny Island via data cables.

The battery capacity (parameter "221.02 BatCpyNom") is to be entered as the nominal capacity for a 20 hour discharge (C20). If this information is not available from the battery manufacturer's datasheet, it can be calculated from the data for different discharge times (120 h, 100 h, 20 h, 5 h, 1 h) in the following manner:

C20	C120/1.18	C20	C10/0.92
C20	C100/1.15	C20	C5/0.81
C20	C20	C20	C1/0.57

SMA recommends the following minimum battery capacities:

- Minimum battery capacity per Sunny Island inverter:
 - Sunny Island 4548-US: 190 Ah
 - Sunny Island 6048-US: 250 Ah
- Minimum battery capacity per 1 kW output power of the PV system: 100 Ah (C20)

The Sunny Island is designed and preset for a nominal battery voltage (parameter "221.03 BatVtgNom") of 48 V (24 cells for every 2 V) with lead-acid batteries (FLA and VRLA) and 45.6 V (38 cells for every 1.2 V) with nickel-cadmium batteries.

i Failure of individual battery cells

If individual battery cells fail over several years of continuous operation, the nominal voltage can be set in the range from 42 V to 48 V. Up to three individual cells can be removed and the plant can still continue to operate.

13.2 Battery Temperature

The Sunny Island continuously monitors the battery temperature using the battery temperature sensor provided. At 9 °F (5 °C) below the maximum permissible temperature (parameter "221.04 BatTmpMax"), a warning message is displayed. If the maximum value for the battery temperature is exceeded, the Sunny Island switches off.

A warning is given if the value for lead-acid batteries falls below 14 °F (-10 °C) and below -4 °F (-20 °C) for NiCd batteries.

The battery temperature is taken into consideration when the charging voltage is calculated (see Section 13.5 "Charge Control", page 111).

NOTICE

The battery may be destroyed due to deep discharge.

If the battery temperature sensor is defective or missing, the Sunny Island continues to run, assuming a battery temperature of 104 °F (40 °C). This can result in deep discharge of the battery in the long run.

- Observe the corresponding warnings of the Sunny Island.
- Connect the battery temperature sensor.
- Replace the defective battery temperature sensor.

13.3 Start Options

If the battery is replaced in a system, the battery management system must be restarted and reconfigured. This can be done using the "Quick Configuration Guide" (QCG) (see Section 8.2 "Starting the Quick Configuration Guide (QCG)", page 69).

13.4 State of Charge (SOC) and State of Health (SOH)

State of Charge (SOC)

The Sunny Island has a very precise internal state of charge calculation (display value "120.01 BatSoc"). The procedure for calculating the state of charge is based on balancing the ampere hours. This means that all currents flowing in and out of the battery are accumulated and referred to the nominal capacity. In order to take into consideration faults caused by self-discharge and charging losses caused by gassing, these losses are already internally extracted. Unlike other operations, no fixed charging factor must be set.

When the full charge states are reached, the battery state of charge is reset to values of 90%, 95% or 100%, depending on how full the battery was actually charged. If default settings are not changed, a state of charge of 90% after boost charge, 95% after full charge and 100% after equalization charge is reached.

Since full charge states are generally only rarely achieved during a grid failure, the operation used here can also utilize the battery voltage during constant discharge phases with low discharge currents to recalibrate the state of charge. Compared to the ampere-hour balancing method, the operation used here exhibits a high level of stability over the long term when recalibrated at regular intervals.

Both the ampere-hour balancing method and the recalibration procedure which is performed via the voltage, automatically adjust to the connected battery over time (depends on the number of grid failures).

The estimated state of charge error (display value "120.11 BatSocErr") will provide you with continuous information on the accuracy of the battery state of charge currently calculated. The average error will continuously diminish as the adjustment to the actual battery state of charge increasingly improves.

State of Health (SOH)

Only when the battery is new does its usable capacity correspond to the capacity specified by the battery manufacturer. As the battery ages and as a result of frequent insufficient charging, the battery's usable capacity may decrease considerably on a permanent or only temporary basis.

The battery's state of health (display value "320.01 Soh") is a measurement of the present useable capacity expressed as a percentage relative to the nominal capacity. 100% means that the entire nominal capacity can be used. 50% means that only half of the original nominal battery capacity can be used. The state of health of the battery is determined using a self-adapting procedure which takes several charging cycles to collect accurate and reliable data.

The current capacity for the Sunny Island is automatically adjusted downwards for temperatures below $< 68^{\circ}\text{F}$ (20°C) because of the significant drop in the usable capacity of the battery when temperatures fall below the rated temperature.

For all lead-acid batteries, the nominal capacity is adjusted by a fixed factor of $-0.6\%/^{\circ}\text{F}$ ($-1\%/^{\circ}\text{C}$). For NiCd batteries, a factor of $-0.4\%/^{\circ}\text{F}$ ($-0.75\%/^{\circ}\text{C}$) is used.

Recalibration of the State of Charge

The Sunny Island recalibrates the display value for the state of charge of the battery to 20% as soon as the battery voltage per cell has reached a limiting value that is dependent on the battery type and the battery capacity. In addition, recalibration of the state of charge always takes place if one of the following conditions is met:

- The nominal capacity is entered incorrectly.
- The battery cable resistance is too high.
- The battery is not connected correctly.
- Differing concentrations of acid in FLA batteries (if necessary, reset the parameters in the menu "222# Battery Charge Mode).
- The battery has aged so much that the SOH is below 80%.

13.5 Charge Control

The Sunny Island uses a three-level charge control, using the IUoU procedure. When operating with the utility grid, a fourth level, Silent Mode, is optionally available.

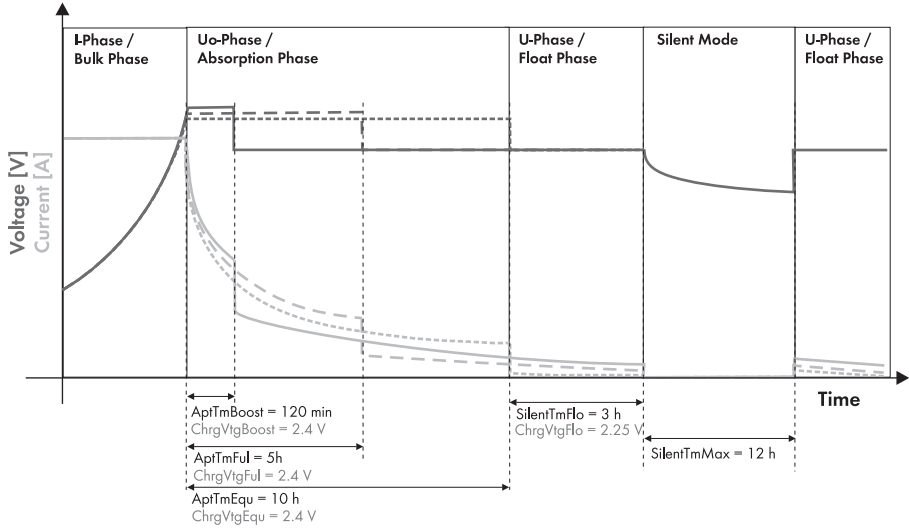

The I stands for the constant current phase (I phase). In this phase, the charging is limited by the maximum defined battery current (parameter "222.01 BatChrgCurMax"), the nominal generator current (parameter "234.03 GnCurNom"), the nominal grid current (parameter "232.03 GdCurNom") or the maximum AC charging current of the Sunny Island (parameter "210.02 InvChrgCurMax"). The respective value reached first is the limiting value. During this phase, the battery voltage increases as the battery is charged.

Once the battery voltage reaches the predefined value for the second phase Uo (parameters "222.07 to 222.09", ChrgVtgBoost or ChrgVtgFul or ChrgVtgEqu), the constant voltage charging (absorption phase) begins.

In this phase, the battery voltage is maintained at a constant level, resulting in a continually decreasing battery current. The Sunny Island remains in this phase for a defined period of time (parameters "222.02 to 222.04", ApTmBoost or ApTmFul or ApTmEqu). For this charging phase, the Sunny Island automatically selects one of three possible charging methods:

- Boost charge (see Section 13.5.1, page 113)
- Full charge (see Section 13.5.2, page 113)
- Equalizing charge (see Section 13.5.3, page 114)

The remaining charging time (display value "120.04 ApTmRmg") of this phase and the actual process (display value "120.05 BatChrgOp") can be read on the display.

The following figure shows the relation and the flowchart of the charging phases and charging processes.

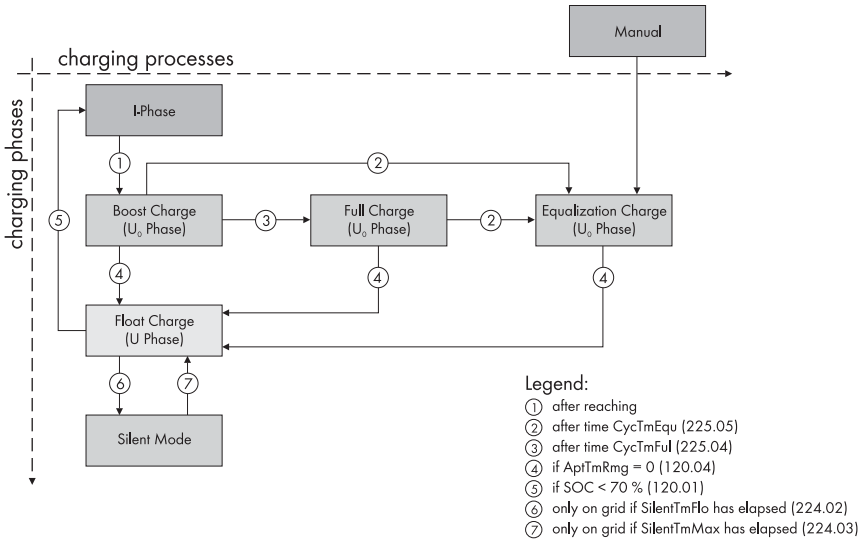

Once this constant voltage phase is finished, the Sunny Island switches to float charge which again carries out constant voltage charging but at a greatly reduced charging voltage (parameter "222.10 ChrgVtgFlo"). The purpose of the float charge is to keep the battery in a fully charged state without causing premature aging through overcharging. The Sunny Island remains in this phase until either more than 30% of the nominal capacity has been used (all discharges are added up) or the state of charge is below 70%. When the Sunny Island is operating on the utility grid, it can also switch from float charge to silent mode.

i Changing the charging voltage

The charging voltage does not change erratically. Instead, it slowly changes to the new setpoint at a rate of approximately 0.5 mV/cell*s when switching from constant voltage charging to float charge. This also happens if the setpoint is set manually.

The charging capability of batteries is highly dependent on the battery temperature. For temperatures <77°F (25°C), the charging voltage must be slightly increased, and for temperatures >77°F (25°C) it must be slightly decreased. This is necessary to prevent overcharging and deep discharge reliably at any battery temperature. For this reason, the Sunny Island is equipped with automatic temperature compensation of the charging voltage. The battery charging voltage is adjusted by:

- VLA and FLRA battery types: 2 mV/°F (4 mV/°C) and cell
- NiCd battery types: 0 mV/°F (0 mV/°C) and cell

The temperature compensation value can be set using the parameter "222.11 BatTmpCps".

13.5.1 Boost Charge

The boost charge is the most common charging process of the Sunny Island. The boost charge ensures a high generator workload through a high charging voltage over a short period of time. With liquid FLA lead-acid batteries, this charge process should be used for gassing and thus compensating the electrolytes. The boost charge process can charge the battery up to approx. 85% to 90%.

13.5.2 Full Charge

Every 14 days or after eight nominal charge throughputs, the Sunny Island automatically initiates a full charge (parameter "222.05 CycTmFul").

i Nominal charge throughput

A nominal charge throughput is reached when the sum of the discharge currents corresponds to the nominal capacity of the battery.

Example: The battery has a nominal capacity of 100 Ah. A nominal charge throughput is reached when the battery has been discharged ten times for one hour by 10 A.

The objective is to recharge the battery to a state of charge of at least 95% and rectify possible effects caused by an insufficient charge. Regular full charging approximately every two to four weeks can double the battery life.

i Change to full charge

If the Sunny Island changes to full charge after a specific time of boost charge has elapsed, the entire time of boost charge elapsed is considered for full charge.

i More than 1% of the nominal battery capacity is discharged

If more than 1% of the nominal battery capacity is discharged during a full charge, 50% of the time elapsed is considered for the next constant voltage phase.

i External charging device

If an external charging device or charge controller is connected to the battery and the criteria for a full charge are fulfilled due to external charging, the Sunny Island treats this as if it had performed the full charge itself.

i Parallel procedures for full charge

Any parallel procedures causing the generator to stop during full charge are not taken into account until the charging process is completed.

13.5.3 Equalization Charge

A battery bank consists of many individual battery cells connected in series which all behave slightly different. Over time, this results in different charge levels in the individual cells. This can lead to premature failure, initially of individual cells, and finally to failure of the entire bank.

The Sunny Island can perform an equalization charge automatically every 180 days (parameter "222.06 CycTmEqu") or every 30 nominal charge throughputs. During equalization charge, it performs controlled overcharging of the battery storage system to ensure that even the weaker cells are fully recharged. Equalization charging extends the battery life by up to 50%. The automatic equalization charging function can also be deactivated (parameter "222.12 AutoEquChrgEnd", activated by default) or manually started (parameter "520.01 ChrgSelMan").

Change to an equalization charge

If the Sunny Island changes to equalization charge after a specific time of boost charging or full charging has elapsed, these times are completely considered for the equalization charge.

More than 1% of the nominal battery capacity is discharged

If more than 1% of the nominal battery capacity is discharged during an equalization charge, 50% of the time elapsed is considered for the next constant voltage phase.

External charging device

If an external charger or charge controller is connected to the battery and the criteria for an equalization charge are fulfilled due to external charging, the Sunny Island treats this as if it had performed the equalization charge itself.

13.5.4 Manual Equalization Charge

The parameter "520.01 ChrgSelMan" activates the manual equalization charge on the Sunny Island. If a generator is connected to the system, it is automatically started and stopped once the equalization charge is completed.

Carrying out the equalization charge

An equalization charge should be performed at least once a year. After long periods of time without charging, e.g. in the case of plants which are only operated seasonally, equalization charges should always be performed manually at the end or at the beginning of the season.

13.5.5 Silent Mode

In addition to the float charge, the silent mode can only be used (parameter "224.01 SilentEnd") when operating on the utility grid.

The main purpose of the silent mode is to save energy by switching from charge mode to standby mode in battery-backup systems where the Sunny Island is predominantly in float charge.

The silent mode is activated after the time set for float charge (parameter "224.02 SilentTmFlo") has expired. The Sunny Island remains in silent mode for a fixed time (parameter "224.03 SilentTmMax") or until the battery voltage per cell is 0.14 V lower than the set voltage (parameter

"222.10 ChrgVtgFlo"). This ensures that the battery is always fully charged, even in silent mode. If a grid failure is detected during silent mode, the Sunny Island makes a stand-alone grid available within 10 ms to 30 ms.

13.6 Battery-Preservation Mode

The Sunny Island has a sophisticated battery-preservation mode. The battery-preservation mode prevents deep discharge from the battery as far as possible when the energy supply is low, thus preventing a total system failure as well as damage to the battery.

The battery-preservation mode has three levels that are activated as a result of the battery state of charge (when the charge falls below the respective limit, parameters "223.05 BatPro1Soc", "223.06 BatPro2Soc" and "223.07 BatPro3Soc"):

Level 1: The first level is used to switch the Sunny Island into standby mode at times when the energy is not necessarily required (e.g. at night). You define the start time using the parameter "223.01 BatPro1TmStr" and the stop time using the parameter "223.02 BatPro1TmStp".

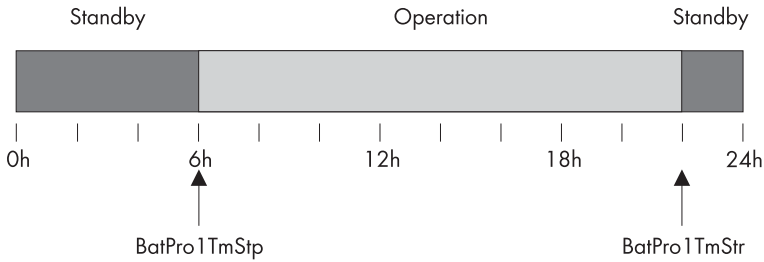

Level 2: The second level of the battery-preservation mode ensures that the Sunny Island is started regularly every two hours only in the time period during which energy supply is expected, and that it attempts to charge the battery from the AC side. For PV plants, this is during the day. In this case, you define the start time using the parameter "223.03 BatPro2TmStr" and the stop time using the parameter "223.04 BatPro2TmStp".

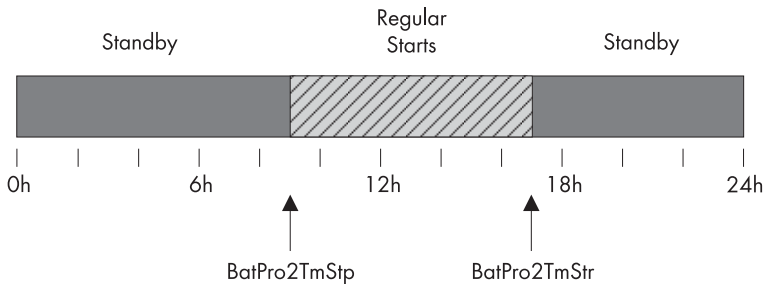

Level 3: The third level ensures that the battery is protected from deep discharge and thus protected against damage. In this case, the Sunny Island is switched off completely.

- To recommission the Sunny Island, restart it (see Section 9.5 "Recommissioning After Automatic Shutdown", page 77).

At all three levels, the Sunny Island is stopped only if no battery charging current flows within ten minutes (limit: 3 A charging current).

The limits for all three levels can be set independently from each other. This allows individual levels to be skipped.



Parameter BatPro1 Soc < BatPro2Soc

If the BatPro1 Soc parameter < BatPro2Soc, level 1 is skipped and only level 2 is carried out.

Battery-preservation mode levels 1 and 2 are automatically quit as soon as an external voltage source (grid reconnection/generator start) is present at the AC2 terminal. For exiting these levels, a hysteresis of 5% of the state of charge is provided.

Only battery-preservation mode of level 3 is not automatically quit if an external voltage source (grid reconnection/generator start) is present.

The battery-preservation mode can be quit by manually starting the Sunny Island. If, within ten minutes (see above), charging current is detected, the Sunny Island continues to operate; otherwise, it switches off again.



Saving potential due to battery-preservation mode

In inverter operation, the Sunny Island draws 25 W of the battery power. If the device is in standby mode, only the on-board power supply, which requires approx. 4 W, is supplied. This results in a savings of 21 W.

Using the conditions described in level 1 of the battery-preservation mode and assuming an operation time from 6 a.m. to 10 p.m., this results in 336 Wh/day. This in turn corresponds to 7 Ah at 48 V and thus 210 Ah per month (30 days).

13.7 Battery Diagnosis

The "320# Battery Diagnosis" menu displays several values that provide information on the past operational behavior of the battery. These values are helpful in checking the efficiency of the set parameters and in viewing the typical operating conditions of the battery (see Section 19.3 "Diagnosis (300#)", page 193).

13.8 Battery Lead Resistance

In menu "221# Battery Property", you can specify the battery lead resistance (BatWirRes). The resistance is the ohmic resistance from the battery to the input of the master device. The default value of the parameter "221.06 BatWirRes" is 0 mΩ .

The resistance is made up of the resistance of cable 1 and fuse and resistance of cable 2:

$$R = R (\text{cable 1}) + R (\text{fuse 1}) + R (\text{cable 2})$$

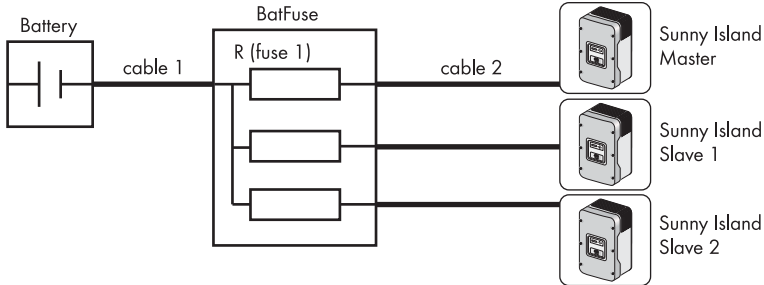

The following applies:

$$R = \rho \frac{L}{A}$$

ρ = specific resistance for copper $\rho = 0.018 \frac{\Omega \text{ mm}^2}{\text{m}}$
 L = Cable length in m (1 m = 3⁹/₃₂ ft)
 A = cross-section area of the cable in mm² (for conversion of cable sizes see page 43)

i **BatFuse**

R (fuse 1) at the BatFuse is approx. 1 mΩ .

14 Connecting External Sources

The Sunny Island supports the integration of external energy sources. Here, a distinction is made between the integration of a generator and the integration of the utility grid.

Both the generator as well as the utility grid are integrated via the AC2 terminal of the Sunny Island. A single-phase, a split-phase and a three-phase connection can be established. In the case of single-phase parallel operation, the transfer relays are operated in parallel, making it possible to use a correspondingly larger current, which in turn allows for a generator or grid connection with a higher capacity

i Connecting in a single-phase parallel system

When installing parallel single-phase systems, the connection cables for AC1 and AC2 of all Sunny Island inverters must have the same wire sizes and cable lengths.

The Sunny Island has separate parameters for the utility grid and the generator. This generally allows both operating modes to be used without making additional adjustments. The parameter settings and display values distinguish between settings or values which are generator-specific or grid-specific and settings or values (EXT) common to both grid and generator.

14.1 Generator

The Sunny Island can start or stop a generator depending on load power or battery state of charge. In this case, diverse limits and times are taken into consideration (see Section 14.1.5 "Automatic Generator Operation", page 123).

Extended Generator Management

If necessary, the Sunny Island and generator supply loads together. The total of the (nominal) power of both energy sources is available in the stand-alone grid.

14.1.1 Parallel Connection

In the case of Sunny Island inverters connected in parallel which operate on the same line conductor and in the same cluster, the internal transfer relay is activated simultaneously. It is thus possible to multiply the generator current and therefore to connect a larger generator or a higher grid current.

The maximum current in the system is limited to 150 A:

Maximum number of Sunny Island	Maximum current
1 Sunny Island	56 A
2 Sunny Island	112 A
3 Sunny Island	150 A

Sunny Island Connected in Parallel to a 120 V Generator

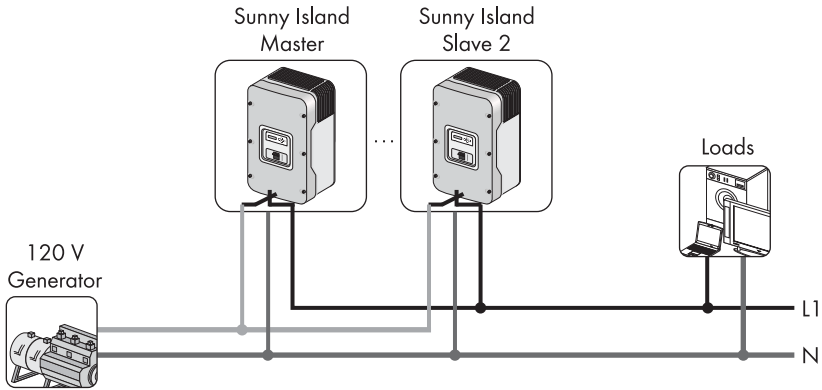

Sunny Island in the Split-Phase System connected to a 240 V Generator

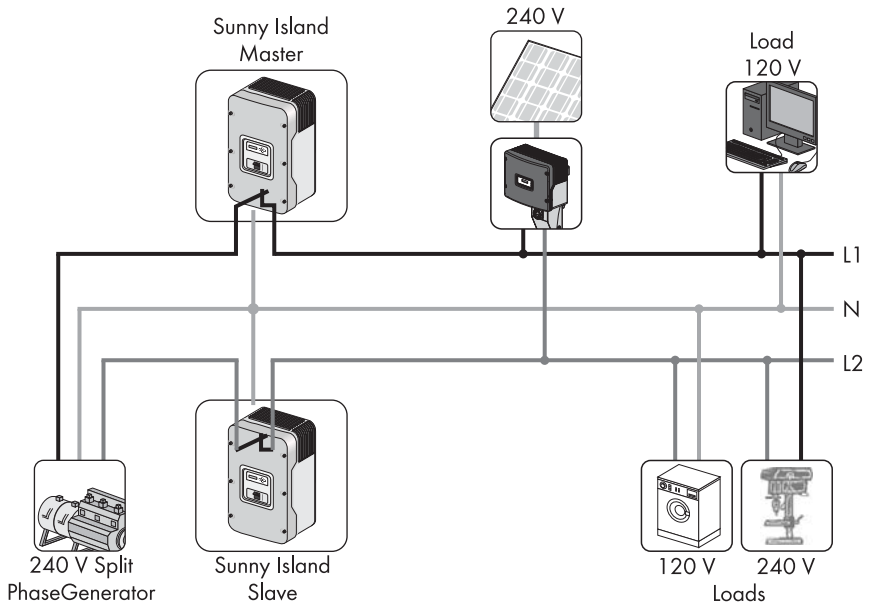

Generally, the internal transfer relays of the slaves close only if the internal relay of the master is closed.

Plants with master and slave unit on one battery (cluster operation) will keep on working if one slave fails. If the master fails, the whole cluster stops its operation.

i Cable length and wire size

Use the same cable length and the same wire size when installing the Sunny Island inverters with the generator.

14.1.2 Generator Start Options

The Sunny Island supports the following options for starting the generator which can be set in standby mode with parameter "234.07 GnStrMod":

- Manual
- Autostart

Manual (Manual Generator Start)

This setting is for generators that do not have an electrical remote starting option and, for example, are started using cable winches, cranks or similar.

In this case, the Sunny Island does not have the option of starting the generator. It only monitors the generator input (AC2). If, while monitoring the input, the device detects that the generator voltage and frequency are within the set limits (see Section 14.1.6 "Limits and Power Control", page 126), the device is synchronized and connected following the warm-up time.

The following figure shows the wiring for a generator that cannot be started remotely:

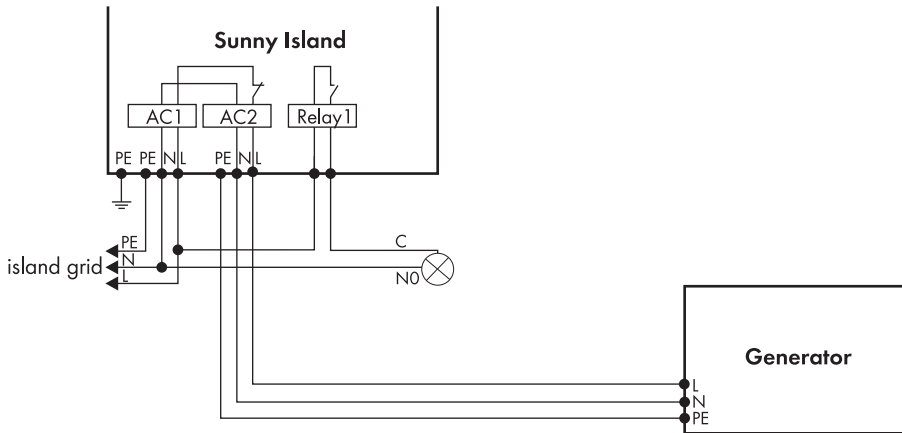

The generator is also always switched off manually. The Sunny Island then automatically switches to operation without generator.

i GenReq signal

The GnReq signal (see Section 1.5 "Relays", page 140) is set for signaling the generator request and can thus be used as an alarm contact (in this case: a bulb). If no request is pending, the signal is reset.

If an internal request is sent while the generator is already running, the signal is disabled until the generator is externally stopped and the stop time has expired (30 seconds).

i Disconnecting the generator

A disconnection device should be positioned between the Sunny Island and the generator. If the generator is to be stopped, it is first manually disconnected using the disconnection device and then it is stopped. This prevents actuation of the generator by the Sunny Island.

Autostart

This allows autostart generators to be directly integrated. They have a separate internal controller that controls the start procedure.

The Sunny Island requests the generator via the GnReq signal. If the generator voltage and frequency are within the set limits (see Section 1.4.1.6 "Limits and Power Control", page 126), the device is synchronized and connected following the warm-up time.

The Sunny Island keeps the request signal active until a disconnection is made and the set power-down time has expired.

i Shut-off delay

Autostart generators can have an internal after-run cycle that is only activated when the request has been disabled. This may result in a longer power-down time.

i Internal warm-up phase

With some generator types, the voltage is only switched to the output after the internal warm-up phase is finished. This is why generator connection is internally time-monitored:

- **2 x "234.12 GnWarmTm" + 2 minutes for manual and automatic start**

The following figure shows the wiring for a generator capable of autostart:

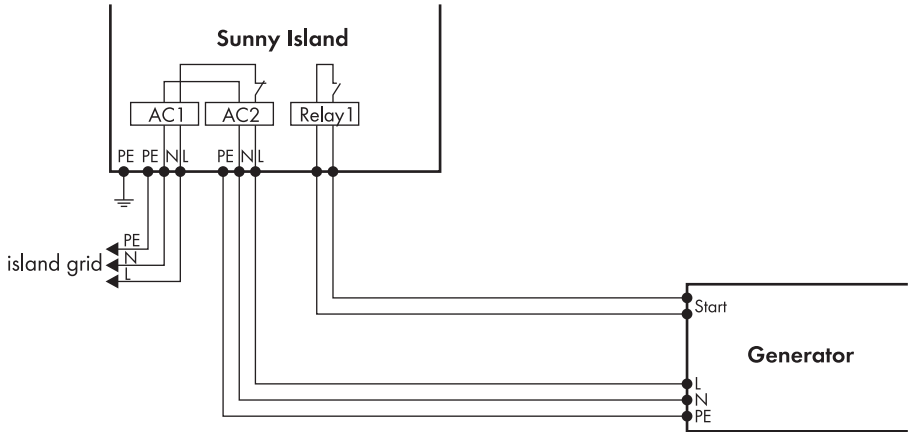

If the generator is started manually in this operating mode, the Sunny Island detects the running generator and connects it once the warm-up time has expired. If you stop the generator externally, this is detected, the generator disconnected and the stand-alone grid is still supplied.

i Generator request

If the generator is running after being externally started and a generator request occurs, the GnReq signal is disabled until the generator is externally stopped again and the stop time has expired.

14.1.3 Generator Operation

The Sunny Island allows automatic operation (depending on the state of charge or load) (see Section 14.1.5 "Automatic Generator Operation", page 123). In addition, manual operation is also possible.

14.1.4 Manual Generator Operation

The manual operating modes for the generator management are tripped using the parameter "540.01 GnManStr". Here, a distinction is made between the following operating modes:

- Auto:** In this operating mode, the generator is automatically started due to the settings. This includes the start via the state of charge or the load power or by the request for a manual equalization charge.
("520.01 ChrgSelMan" = Start).
- Stop:** The generator is manually stopped. The current generator request is canceled – immediate disconnection from generator and change to lock state. Once the lockout time has ended, the generator switches into automatic operation.
- Start:** Manual generator start – the generator runs "continuously" until stopped. The generator can only be manually stopped.

Run1h: Operation for one hour. Once the lockout time has expired, the transition back into automatic mode follows.

An equalization charge can be manually started using the parameter "520.01 ChrgSelMan". This sets the battery management (see Section 13 "Battery Management", page 108) in the equalization charge state and the generator is requested. This request persists until equalization charge has been completed.

The following flowcharts provide an overview of the start/stop behavior of the Sunny Island during manual generator operation:

Generator Interface "234.07 GnStrMod" = Manual; Start at the Generator

- 1 Manual generator start
- 2 "Generator is running" detected, beginning of warm-up phase
- 3 Internal generator request is ignored
- 4 Warm-up phase is completed, generator is connected
- 5 Generator current limit
- 6 Current is reduced, battery absorption phase
- 7 Manual generator stop, disconnection of the generator
- 8 Minimum stop time has expired

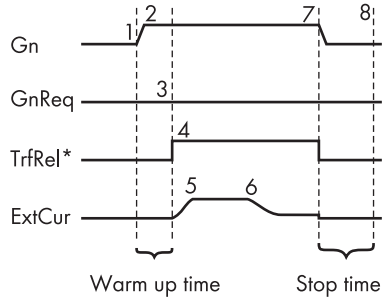

* Transfer relay

Generator Interface "234.07 GnStrMod" = Autostart; Start at the Generator

- 1 Manual generator start
- 2 "Generator is running" detected, beginning of warm-up phase
- 3 Warm-up phase completed
- 4 Generator is connected
- 5 Generator current limit
- 6 Current is reduced, battery absorption phase
- 7 Manual generator stop, disconnection of the generator
- 8 Generator is disconnected, beginning of stop time
- 9 End of stop time

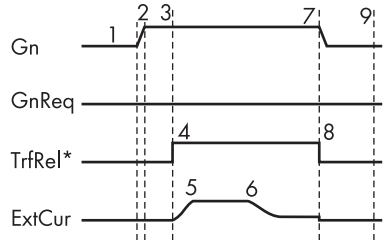

* Transfer relay

14.1.5 Automatic Generator Operation

In automatic operating mode (parameter "235.01 GnAutoEna"), the Sunny Island automatically defines the settings (depending on battery state of charge or load) as to when the generator starts and how long it runs. The automatic operating mode is activated using GnAutoEna = On (default). If GnAutoEna = Off, the automatic operating mode is deactivated.

In addition, the user can also manually start and stop the generator, if required.

i Charge State Dependent Start

The Sunny Island changes to the operating mode "Stop/Lock" when stopped manually during automatic operation.

- Manual inputs on the Sunny Island have a higher priority than automatic operation.
- If the Sunny Island is manually stopped while the automatic operating mode is activated, it switches to stop/lock operating mode.
- If generator automatic start is activated and the conditions for automatic operation are met, the Sunny Island changes back into the operating mode "Start" after lock time (or manual acknowledgment with the parameter "540.02 GnAck").

The time periods t1 and t2 are defined using the parameters "235.07 GnTm1Str" and "235.08 GnTm2Str". The start time for t1 (and thus the end of t2) is defined using GnTm1Str, and the start time for t2 (end of t1) is defined using GnTm2Str.

i GnTm1Str = GnTm2Str

If GnTm1Str = GnTm2Str, only t1 is activated!

The time intervals t1 and t2 are assigned charge states for start-up and stop with the parameters "235.03 GnSocTm1Str", "235.04 GnSocTm1Stp", "235.05 GnSocTm2Str" and "235.06 GnSocTm2Stp". GnSocTm1Str designates the battery state of charge at which the generator is started during the t1 time and GnSocTm1Stp designates the state of charge at which the generator is switched off during t1. The GnSocTm2Str and GnSocTm2Stp parameters are similarly defined during the time t2.

The following figure shows an example of the settings if operation of the generator at night is to be avoided as much as possible. From 6 a.m. to 10 p.m., the generator is activated at a state of charge (SOC) of 40%, at night (from 10 p.m. to 6 a.m.), however, the state of charge of the battery is allowed to drop to 30% before the diesel generator is activated.

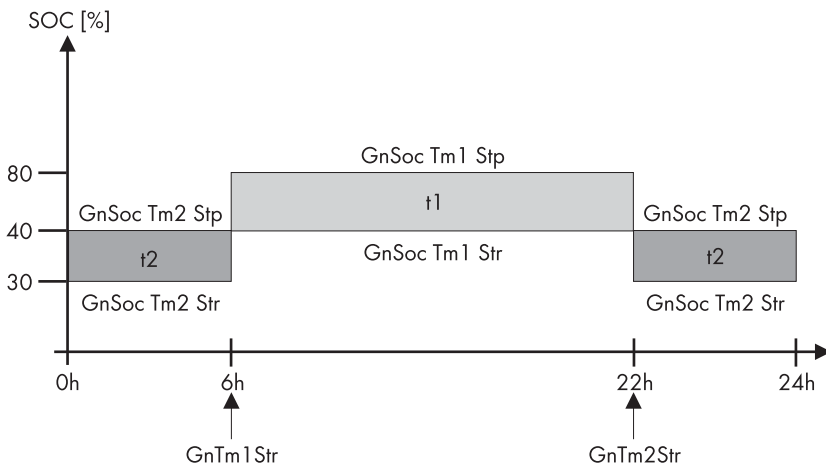

i Reaching the float charging process

If the float charging process (see Section 13.5 "Charge Control", page 111) is activated before the cutoff limit (GnSocTm1Stp or GnSocTm2Stp) is reached, the generator request is disabled again. If a full or equalization charge is active, the generator is only stopped after this charge is completed and not when "235.04 GnSocTm1Stp" or "235.06 GnSocTm2Stp" is reached.

Load-Dependent Start

In case increased energy demands arise, the generator can be requested for support. This function can be switched on or off (default) using the parameter "235.09 GnPwrEna". The function is only effective if the parameter "235.01 GnAutoEna" is simultaneously set to On.

The load limit for the request and the generator stop is configured using the parameters "235.10 GnPwrStr" and "235.11 GnPwrStp". The average time by which an average value for the load power is calculated can be set using "235.12 GnPwrAvgTm". This prevents temporary power consumption peaks of a few seconds from causing a power-dependent generator start.

If the generator has been started due to the load, it runs according to the minimum generator run time. If, once this time has expired, the average power is below the cutoff limit, the generator is stopped again.

i Multi-Phase System

Only the total load power of all line conductors is monitored. Individual line conductors in a multi-phase system are not monitored.

The load power is calculated using the Sunny Island power (parameter "111.01 TotInvPwrAt") and generator power (parameter "131.01 TotExtPwrAt").

The following flowcharts provide an overview of the start/stop behavior of the Sunny Island during automatic generator operation:

Generator Interface "234.07 GnSrtMod" = Manual; Request Via Sunny Island

- 1 Generator is requested via Sunny Island
- 2 Manual generator start
- 3 "Generator is running" detected, beginning of warm-up phase
- 4 Warm-up phase is completed, connection
- 5 Generator current limit
- 6 Minimum run time has expired
- 7 Current is reduced, battery absorption phase
- 8 Charging process is completed, request signal is disabled
- 9 Manual generator stop
- 10 Generator separation
- 11 Stop time has expired

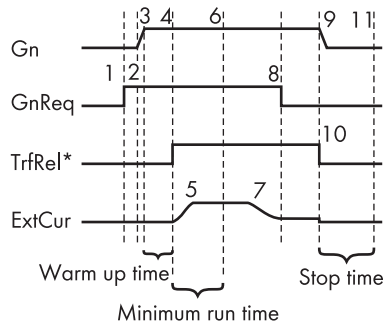

Generator Interface "234.07 GnSrtMod" = Autostart; Request Via Sunny Island

- 1 Generator started by Sunny Island
- 2 Generator start
- 3 Beginning of warm-up time
- 4 Warm-up time has expired
- 5 Generator is connected
- 6 Current limit
- 7 Minimum running time is expired
- 8 Current is reduced, battery absorption phase
- 9 Charging process is completed, generator disconnection
- 10 Generator follow-up time expired, generator disconnection
- 11 Stop time has expired

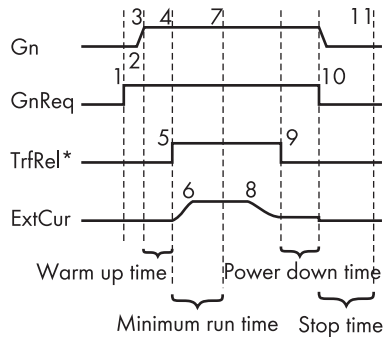

i Power-dependent generator start

Warm-up times, minimum run times and power-down times are also maintained for power dependent generator starts.

14.1.6 Limits and Power Control

The voltage limits can be set using the parameters "234.01 GnVtgMin" and "234.02 GnVtgMax" and the frequency limits for generator operation can be set using the parameters "234.05 GnFrqMin" and "234.06 GnFrqMax". If the values are outside these permitted limits, the generator is disconnected. Slightly narrower limits apply to generator connection.

i System voltage (AC)

The system voltage (AC) depends on the generator voltage when the generator is running.

The voltage and frequency limits are monitored in phases. At least the phase on the master device must comply with the limits defined for connecting the generator. If the limits are not maintained, slave devices, where applicable, connect or disconnect individually.

i Generator disconnection by the master

If the master device disconnects the generator, all slave devices are disconnected as well.

i Generator disconnection by a slave

If a slave device is disconnected from a generator (and the master continues to be connected to the generator), the slave device can reconnect once the voltage and frequency are within the valid range again.

In this case, a monitoring period is running. Only after the time for the parameter "234.12 GnWarmTm" has expired and after voltage and frequency are determined to be valid does reconnection take place.

The Sunny Island charges the generator at each line conductor with the current defined in the parameter "234.03 GnCurNom" as a maximum. The power that is not directly used by the loads flows into the battery for charging. At the same time, the limits for the AC charging current limit (parameter "210.02 InvChrgCurMax") on the Sunny Island and the DC charging current limit (parameter "222.01 BatChrgCurMax") are active.

Low values for this limit may be the reason why the defined generator current cannot be adjusted. If the battery voltage reaches the charging voltage target value, it is also reduced (absorption phase) (see Section 13.5 "Charge Control", page 111).

i Value for parameter "234.03 GnCurNom"

A sensible value for parameter "234.03 GnCurNom" is approximately 80% of the maximum generator current for each line conductor.

If the parameter "234.15 GnCtlMod" is set to CurFrq, the generator is also limited at frequencies lower than the nominal frequency (parameter "234.04 GnFrqNom"). This function can be used if the full generator power is not always available and you want to prevent the generator from being overloaded. The default setting is only intended to control the nominal generator current.

If the current set using the parameter "234.03 GnCurNom" is not sufficient for powering the loads, the battery provides support ("real generator support").

The Sunny Island provides all the required reactive power.

14.1.7 Run Times

If the generator is started (or the Sunny Island detects an external generator start), the warm-up phase starts. If, during this time, the voltage or frequency detected is not within the permissible range, the warm-up time begins again.

If the generator cannot be connected at the GenMan within twice the time set at "234.12 GnWarmTm" + 2 minutes, the connection process is canceled and a new attempt is made. After three attempts, the system changes to error state (Fail "GnNoSync").

If the generator has been connected, the minimum run time begins (parameter "234.08 GnOpTmMin"). The generator remains connected during this time, even if in the meantime the generator request is no longer pending.

If the minimum run time has ended and a generator request is no longer present, the generator disconnects and enters the power-down time (Cool). If this power-down phase is completed after the "234.10 GnCoolTm" time, the generator is stopped.

If a generator fault (e.g. generator failure) is detected, the generator is also disconnected and then stopped immediately. In doing so, the follow-up time is skipped.

Once the stop time (parameter "234.09 GnStpTmMin") has elapsed, the generator is ready for the next request.

i Disabling the internal generator request

An internal generator request is disabled during the after-run time and stop time or in error state.

If a generator fault is detected several times and the number of autostarts (parameter "235.02 GnAutoStr") has been exceeded, the system transitions into the locked error state.

This state lasts for the time period set at "234.11 GnErrStpTm". Once this time has expired, the generator is ready for another attempt.

i Autostart meter

The recording of autostarts is only reset after the generator has been successfully connected and the minimum run time has expired or when the locked error state (Fail Lock) is disabled.

i Error status

The error state and also the blocked error state can be quit by acknowledging the generator error (parameter "540.02 GnAck").

The display value "133.03 GnRmgTm" is used to display the remaining time of the generator meter. Depending on the current request or the phase in which the generator state machine is, the following times are displayed:

- Remaining time of Run 1h
- Remaining run time during the warm-up phase (Warm)
- Remaining minimum run time in operation (Run)
- Remaining run time during the follow-up time (Cool)
- Remaining stop time after the follow-up time has expired (Lock)
- Remaining time in the error state (Fail)
- Remaining time in the locked error state (FailLock)

14.1.8 Operation Together with PV Inverters and Wind Power Inverters

NOTICE

Incorrect plant designs will result in excessive AC power of the PV inverters or wind power inverters

Damage to the Sunny Island.

- The maximum AC power of the connected PV inverters and the connected wind power inverters must not exceed 9 kW per SI 4548-US-10 or 12 kW per SI 6048-US-10.
- Observe the following:

$$P_{AC \max} \text{ of the PV inverter} = 2 \times P_{AC \text{ nom}} \text{ of the Sunny Island}$$

$$P_{AC \max} \text{ of the wind power inverter} = P_{AC \text{ nom}} \text{ of the Sunny Island}$$

If the battery is fully charged, the frequency limits the power output of the AC feed-in generators (Sunny Boy). If the generator is now manually started, for example, the frequency would be lowered, if required, as the Sunny Island synchronizes with the generator. The AC feeding-in generators (Sunny Boys) would then feed additional energy into the system and possibly overload the batteries. In order to prevent this, in this case the stand-alone grid frequency is temporarily increased, in line with the synchronization, until the AC feed-in generators (Sunny Boy) are disconnected from the stand-alone grid as a result of the grid limits being exceeded.

14.1.9 Stopping the Generator

If the generator was started via the Sunny Island (automatically or manually), it can be manually stopped at any time using the parameter "540.01 GnManStr". This disconnects the generator (the minimum run time is not taken into account here) and the power-down time (Cool) is skipped. Afterwards, the system enters the stop time (Lock).

⚠ DANGER

Electric shock through residual voltage in the off-grid system due to generator shut-off delays

Death or serious injuries. The power-down times depend on the generator type. During the follow-up time, there is still grid voltage at the loads.

- Wait until there is no voltage on the generator.
- Measure voltage to ensure that none is present in the system.

i Generators with manual start option

Generators with the "manual" start option can generally only be started and stopped at the generator.

i Generator start prevented

If the generator start is to be disabled after a manual stop, this must be performed by setting the parameter "235.01 GnAutoEna" to "Off".

14.1.10 Stopping the Sunny Island

If the Sunny Island is stopped by the user, the generator is immediately disconnected. The generator is then stopped (generator request, GnReq, is disabled). The power down time (Cool) is skipped and the system enters the stop time.

i Generator can be operating while Sunny Island is stopped

If the generator is started directly at the generator management box or the generator, it can only be stopped there again. Stopping the Sunny Island here only disconnects the generator and the system transitions into the stop time (Lock).

14.1.11 Disturbances

Reverse power

If the reverse power (parameter "234.13 GnRvPwr") set for the time "234.14 GnRvTm" is exceeded, the generator is disconnected and stopped. The power-down time (Cool, parameter "234.10 GnCoolTm") is skipped and the system transitions into the minimum stop time (Lock). After reverse power, connection is blocked for at least "231.03 ExtLkTm" or "234.09 GnStpTmMin".

i Reverse power

Observe the reverse power which the Sunny Island can generate. The generator must provide this protection; observe the information of the generator manufacturers.

Generator Failure

If a generator failure is detected (failure on the master phase), the generator is disconnected immediately and a stop signal occurs on generator. The system enters the minimum stop time (Lock).

Generator Phase Failure

The failure of a line conductor (e.g. broken fuse) on a slave device is treated as a line conductor failure. The slave device then disconnects this line conductor. If the line conductor is detected as being available again, it is reconnected after the warm-up time "234.12 GnWarmTm" has elapsed.

The line conductor failure on the master device is treated as a generator failure (see above).

Slave Device Failure

You can influence the behavior of the cluster upon failure of a slave device (see Section 1.2.9 "Behavior in the Event of a Failure in a Three-Phase System", page 107).

14.2 Utility grid

The Sunny Island supports the operation of battery-backup systems. Here, a distinction is made between two main states: either a utility grid and stand-alone grid are connected or a utility grid and stand-alone grid are disconnected. The operating mode of the Sunny Island is derived from this. If the stand-alone grid is disconnected, the Sunny Island alone is responsible for powering this stand-alone grid. If the utility grid is connected to the stand-alone grid, the stand-alone grid is powered from the utility grid. Voltage and frequency in the stand-alone grid are identical with the utility grid.

i RS485 communication between the Sunny Island and PV inverters

If a battery-backup system is connected to the Sunny Island, the RS485 communication between the Sunny Island and the PV inverters is necessary (see Section 6.5.1 "Connection of the Interface for External Communication", page 62).

i Operating mode "Grid Charge"

Under specific conditions, the system can also temporarily feed energy from the stand-alone grid into the utility grid in the operating mode GridCharge (parameter "232.08 GdMod").

14.2.1 Limits of the Voltage Range and Frequency Range

In order to operate on the utility grid, very strict limits (for voltage and frequency) must generally be maintained. These strict limits are not sensible for generator operation. The limits are therefore set separately for grid operation and the generator limits are not used.



Default values

The default values for limits during grid operation comply with the following standards:

- For 120 V₆₀ Hz: UL1741

14.2.2 Starting the Sunny Island

The Sunny Island always starts in stand-alone mode. Once the device is operating, it checks for the presence and validity (voltage and frequency) of the utility grid.

14.2.3 Operation in Case of a Grid Failure in a Battery-Backup Grid

If the utility grid fails, the Sunny Island supplies the requirements of the protected load switch. At the same time the Sunny Island serves as the voltage source for Sunny Boy inverters or any other grid-compatible power source.

If the supply of energy from the power source exceeds the requirements of the protected load switches, the energy surplus will be used by the Sunny Island to charge the batteries.

14.2.4 Battery-Backup Operation and Anti-Islanding

In general, Sunny Boy inverters in battery-backup systems feed in energy into the utility grid. According to UL1741 an anti-islanding has to be active. During normal operation, the Sunny Island performs this verification. The battery inverter is connected to the Sunny Boy via a CAT5 cable using a RS485 communication. This communication line signals the Sunny Boy that the Sunny Island is active and monitors the utility grid.

Whenever this information is missing (in the event of maintenance or interference) the Sunny Boy inverters switch from the "OffGrid" setting to the "grid tied" setting and take on the anti-islanding function. This ensures that an anti-islanding is active at all times according to UL1741 when feeding into the utility grid.

If the Sunny Island continues working, it orders the Sunny Boy inverters to switch back to the "OffGrid" setting and performs the anti-islanding.

This function can be realized with the Sunny Island inverters in combination with the compatible PV inverters. You will find the list with compatible PV inverters in the download area at www.SMA-America.com in the Technical Information "PV Inverters: Use of PV Inverters in Off-Grid Systems and Battery-Backup Systems North America and South America".

RS485 Piggy-Backs must be installed in both the Sunny Island and in the Sunny Boy inverters. In addition, a CAT5 cable is needed.

14.2.5 Grid Reconnection

In stand-alone mode, the Sunny Island constantly checks whether the grid has been reconnected (see above). The following conditions have to be fulfilled to guarantee that the Sunny Island synchronizes with the utility grid and connects to the utility grid:

- The frequency of the utility grid must be between the values of the parameters "232.05 GdFrqMin" and "232.06 GdFrqMax" for the time defined in the parameter "232.07 GdVldTm".
- The voltage of the utility grid must be between the values of the parameter "232.01 GdVtgMin" and 5 V below the parameter "232.02 GdVtgMax" for the time defined in parameter "232.07 GdVldTm".

14.2.6 Grid Operation

During grid operation, the stand-alone grid and the utility grid are connected. The Sunny Island is connected along with the stand-alone grid to the utility grid. In this case, the voltage and frequency in both grids are identical.

Disturbances of the utility grid

All disturbances of the utility grid affect the stand-alone grid during grid operation.

In grid operation, the grid monitoring checks whether the permissible limits for voltage and frequency (see grid reconnection) are maintained or whether the grid fails to assume supplying the stand-alone grid. For this, the utility grid is disconnected (battery-backup operation).

The battery is generally charged or its charge is maintained on the utility grid.

Charge Mode

Charge mode on the utility grid is indicated by energy flowing to the battery. The battery is charged until the respective charge process (Boost, Full, Equalize) has been completed and the system changes to float charge (Float) (see Section 13.5 "Charge Control", page 111).

Utility grid as generator: charging the Sunny Island via the utility grid to avoid deep discharge

Manual grid start deactivates settings for automatic grid start

Via the parameter "560.01 GdManStr", you can define whether the utility grid is to be connected or not:

- "Stop": the utility grid will never be connected.
- "Start": the utility grid is always connected.
- "Auto": the utility grid connects automatically and protects the battery from deep discharge.

The following section describes how to perform the settings for an automatic grid start.

You can configure the Sunny Island in such a way that it charges its battery automatically via the utility grid as soon as the state of charge is low. To activate this function, set the parameter "232.41 GdSocEna" to "Enable" and the parameter "560.01 GdManStr" to "Auto."

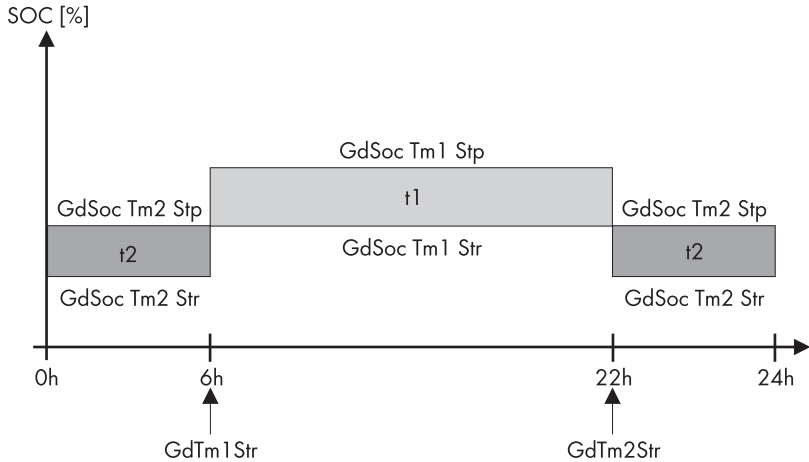

The Sunny Island connects to the utility grid when the state of charge of its batteries lies within the limits determined by the following parameters:

- "233.01 GdSocTm1Str" to "233.02 GdSocTm1Stp"
- "233.03 GdSocTm2Str" to "233.04 GdSocTm2Stp"

The Sunny Island distinguishes between two time periods for which you can set different thresholds for connecting to and disconnecting from the utility grid via the above mentioned parameters. These two time periods are subdivided via the following parameters:

- "233.05 GdTm1Str"
- "233.06 GdTm2Str"

The Sunny Island charges its batteries using the battery charging process which is set via the parameter "233.09 GdStrChrgMod".

Utility grid as generator: connecting the utility grid as soon as the loads request high power from the Sunny Island

You can configure the Sunny Island in such a way that it automatically connects to the utility grid once the connected loads request high power from the Sunny Island. To activate this function, set the parameter "232.42 GdPwrEna" to "Enable". The Sunny Island connects to the utility grid when the power requested by the loads is within the limits determined by the following parameters:

- "233.07 GdPwrStr" to "233.08 GdPwrStp"



Grid feed-in into the utility grid

If the parameter "232.08 GdMod" is set to "GridFeed", the Sunny Island can feed into the utility grid, regardless of whether parameter "232.42 GdPwrEna" is enabled or disabled.

Silent Mode

In order to save energy, the silent mode can be activated using the parameter "224.01 SilentEna" set to "Enable" (default disable). In this case, the Sunny Island is set to standby mode if the charge has been completed and the battery has been in float charge for some time (see Section 13.5.5 "Silent Mode", page 114).

The silent mode is quit regularly to recharge the battery.

In a single-phase parallel Sunny Island system, only the master detects a grid failure in silent mode. The slaves do not detect a grid failure in silent mode.

Feed-In Operation

Whether energy is fed from the stand-alone grid into the utility grid is controlled using the parameter "232.08 GdMod".

The wire size to the utility grid must be appropriate for the maximum current. This ensures that the Sunny Island can feed into the utility grid with a full battery and at full solar irradiation.

In all cases, make sure to consult your grid operator if grid feed-in is possible.

If GdCharge is set, no energy is fed into the grid. If GridFeed (Default) is set, energy is fed into the grid.



Grid feed-in from the DC side into the utility grid

In order to allow electricity to be fed from the DC side into the utility grid, the battery voltage in a charged battery (on the utility grid) must be increased by external DC chargers or the Sunny Island Charger above the nominal charging voltage.

AC feed-in generators on the stand-alone grid side (Sunny Boy) can feed their energy into the utility grid through the internal transfer relay of the Sunny Island; limitations (see Section 14.1.6 "Limits and Power Control", page 126).

The following illustration shows the direction of energy flow for the "Net Metering" and the energy consumption from the utility grid.

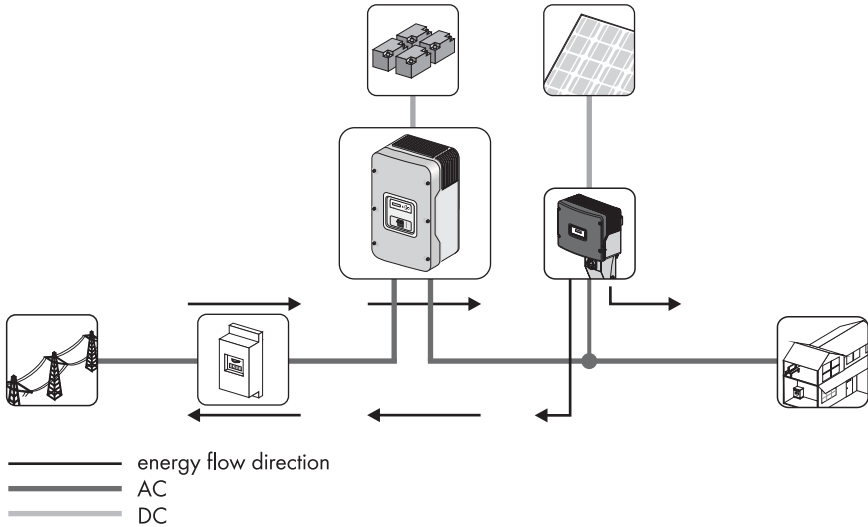

14.2.7 Grid Failure

A grid fault is characterized by the voltage or frequency being outside of the permissible limits (see Section 14.2.5 "Grid Reconnection", page 132) or the utility grid being disconnected. In this case, the time limits are relevant: smaller deviations are permitted for longer than large deviations (see Section 14.2.1 "Limits of the Voltage Range and Frequency Range", page 130).

In case of a grid fault/failure, the utility grid is disconnected and the inverter starts from silent mode.

i Waking up from the silent mode

If the Sunny Island is in silent mode when there is a utility grid failure, there is a short grid failure in the stand-alone grid (see Section 13.5.5 "Silent Mode", page 114).

14.2.8 Disturbances

Reverse Power

If the reverse power (parameter "232.09 GdRvPwr") set for the time "232.10 GdRvTm" is exceeded, the generator is disconnected from the utility grid. After reverse power, connection is blocked for at least "231.03 ExtLkTm".

Failure of the Utility Grid

If a grid failure is detected (failure on the master line conductor), the utility grid is disconnected immediately.

Failure of a Grid Line Conductor

The failure of a line conductor (e.g. broken fuse) on a slave device is treated as a line conductor failure. The slave device then disconnects this line conductor. If the line conductor is detected as being available again, it is reconnected.

The line conductor failure on the master device is treated as a grid failure (see above).

Failure of a Slave

If a slave fails, the system continues to operate using the remaining devices of the cluster.

14.2.9 Limitations and Power Control

The Sunny Island burdens the utility grid at each line conductor with the current defined in parameter "232.03 GdCurNom". The power that is not directly used by the loads flows into the battery for charging. At the same time, the limits for the AC charging current limit (parameter "210.02 InvChrgCurMax") on the Sunny Island and the DC charging current limit (parameter "222.01 BatChrgCurMax") are active. If the battery voltage reaches the charging voltage target value, it is also reduced (see Section 13.5 "Charge Control", page 111).

If the current set using the parameter "232.03 GdCurNom" is not sufficient for supplying the loads, the battery provides support.



Silent mode active

When silent mode is activated, the grid cannot be supported.

The grid may temporarily fail. This way, the voltage supply of the loads will be interrupted for a short time.

14.2.10 Operation Together with PV Inverters and Wind Power Inverters

NOTICE

Overload of the Sunny Island through high currents. Destruction of the Sunny Island

If the current via the relay exceeds the maximum permissible current, the Sunny Island disconnects from the utility grid (relay protection).

- The quantity of PV power installed in the stand-alone grid must never exceed the maximum quantity allowed by the AC input (see Section (see Section 22 "Technical Data", page 227)).
- The maximum AC power of the connected PV inverters and wind power inverters must not exceed 7 kW in grid-tie systems.
- Observe the following:

$$P_{AC \max} \text{ of the wind power inverter} = P_{AC \text{ nom}} \text{ of the Sunny Island}$$

NOTICE

Abrupt switching from the utility grid to the generator and vice versa can lead to the destruction of the Sunny Island

- If an automatic switch is installed, make sure that it completely disconnects the Sunny Island from the utility grid and from the generator for at least five seconds.
- If a manual switch is installed, leave the switch in the OFF position for at least five seconds before switching to the new position.
- If no switch is installed, install a switch (see Technical Information „Sunny Island 4548-US / 5048-US / 6048-US: Grid Backup with Generator“ at www.SMA-America.com).

The requirements of the generator and the utility grid demand different settings of the Sunny Island. In a battery-backup system with generator, the Sunny Island needs a signal circuit via the DigIn input. The DigIn input notifies the Sunny Island when the utility grid is feeding in.

The Sunny Island has one AC external source connection labeled AC2 Grid/Generator. With only one external connection, the DigIn input is used to distinguish between the generator or line voltage. If the DigIn input detects an open electric circuit, the Sunny Island is operated with grid parameters and can feed excess current into the utility grid. When the DigIn input has a closed electric circuit the Sunny Island recognizes that a generator is available.

When using a generator, install an automatic transfer switch which is able to switch from the utility grid to the generator. This can be an automatic transfer switch (ATS) or a manual transfer switch. An automatic transfer switch provides an automatic changeover between generator and utility grid. In the event of a grid failure, no intervention by the operator is necessary.

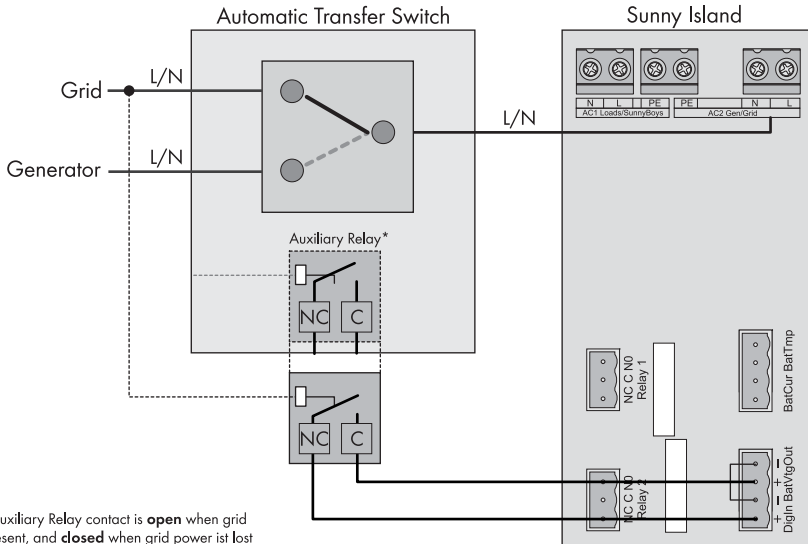

*Auxiliary Relay contact is **open** when grid present, and **closed** when grid power ist lost

In order to switch the signal circuit via the DigIn input, a single pole break contact or a single pole auxiliary relay with a 120 V coil is necessary. If there is no auxiliary relay present in the ATS, you must install an external contactor with a 120 V or 240 V coil. The coil is supplied with voltage via the utility grid.

Treat this electric circuit as a communication circuit and do not connect it in parallel to AC voltage and current cables. Running this circuit parallel to AC voltage and current conductors may cause interference in the signal and give the Sunny Island an incorrect signal. No voltage should be present on the relay during a grid failure. For external relays, pull voltage from the grid side of the transfer switch.

The auxiliary relay can be a part of the automatic transfer switch or a separate assembly.

The signal circuit occupies two auxiliary contactors at the DigIn input:

1. Connect the negative terminal of the DigIn terminal to the negative terminal of the BatVtgOut terminal.
2. Connect the positive terminal of the DigIn terminal to a NO terminal of an auxiliary contact of the transfer switch.
3. Connect the positive terminal of the BatVtgOut terminal to the second contact of the same auxiliary contact on the transfer switch.

An auxiliary contact is used because the Sunny Island must "know" whether it is connected to the utility grid or whether it must manage a diesel generator.

To enable such an operation, you must set parameter "231.06 ExtSrc" to "GenGrid" (see Section 8.2 "Starting the Quick Configuration Guide (QCG)", page 69).



Settings performed on the generator and utility grid

All the settings made for the generator and utility grid in the sub-menus also apply to the "GenGrid" selection.

15 Relays

The Sunny Island offers you several options for the control of internal and external processes. Two multi-function relays are integrated into the device to which you can assign functions using the parameters "241.01 Rly1Op" and "241.02 Rly2Op" (see Section 6.4.6 "Multifunction Relay 1 and 2", page 58).

The different settings have the following meanings:

Function/ Setting	Meaning	Function description
Off	Off	Relay remains permanently switched off (deactivated).
On	On	Relay remains permanently switched on (e.g. relay function test during commissioning).
AutoGn	Automatic generator request	The generator is automatically activated due to set criteria (see Section 14.1.5 "Automatic Generator Operation", page 123).
AutoLodExt	Automatic load shedding dependent on an external source	Automatic connection / disconnection of loads. Connection occurs if the device is connected to an external source (e.g. generator), or if the Lod1 Soc limits are exceeded (see Section 12.1 "Load Shedding", page 103).
AutoLodSoc1	Auto LoadShedding Soc1	Automatic connection / disconnection of loads. Connection only if Lod1Soc limits are exceeded (see Section 12.1 "Load Shedding", page 103).
AutoLodSoc2	Auto LoadShedding Soc2	Automatic load disconnection. Connection only if Lod2Soc limits are exceeded (see Section 12.1 "Load Shedding", page 103).
Tm1	Timer 1 (time-controlled switching of relay 1)	Programmable timer (once, daily, weekly) with duty cycle.
Tm2	Timer 2 (time-controlled switching of relay 2)	Programmable timer (once, daily, weekly) with duty cycle.
AptPhs	Absorption phase is active	Relay switching when battery charge is in absorption phase.
ExtPwrDer	External power reduction	The Sunny Island controls additional loads in order to put excess energy to practical use. When excessive energy can be used, the multifunction relay is activated.
GnRn	Generator active	Relay switching when generator is in operation and connected.

Function/ Setting	Meaning	Function description
ExtVfOk	External voltage and frequency OK	External voltage and frequency are within the valid range for connection.
GdOn	Utility grid	Relay switching when utility grid is available and connected.
Error	Error	Sunny Island has a fault; in case of fault, contact is open (relay is deactivated). If the autostart is activated, the error status will be left within 15 s and restart triggered. If the start is unsuccessful this procedure will be repeated until the autostart counter has expired.
Warn	Warning	The Sunny Island has warning pending. If the warning disappears, the "Warning" state is quit. When a warning disappears depends on the type of warning.
Run	Run	Sunny Island is in operation, contact is closed (relay is activated) if the device is running in inverter operation.
BatFan	Battery Fan	Relay is used for automatic battery room ventilation (switching the fan). The "BatFan" function is responsible for the ventilation of the battery room and provides ventilation of the room in the event of battery gassing.
AcidCir	Acid Circulation	Relay is used for automatic acid circulation (switching the electrolyte pump) The acid circulation enables mixing of the acid and thus reduces acid stratification in the battery.
MccBatFan	Multicluster battery fan	Relay is used for automatic battery room ventilation (switching the fan). "MccBatFan" is the request from the master of the main cluster that is transmitted to a master of an extension cluster in order to use its relay for the battery room ventilation.

Function/ Setting	Meaning	Function description
MccAutoLod	Multicluster auto Loadshedding	Automatic disconnection of the loads via an extension cluster in the Multicluster system "MccAutoLod" is the request from the master of the main cluster that is transmitted to a master of an extension cluster in order to use its relay for the automatic disconnection of the loads.
CHPReq	Request CHP plant	Request of the CHP plant through the CHP plant control
CHPAdd	Request additional CHP plant	Request of additional CHP plant through the CHP plant control
SiComRemote	Remote control	The relay can be controlled remotely.
Overload	Overload	When using the output limitation of the Sunny Island (temperature-dependent), the relay will be opened. "Overload" is directly linked to the derating warning and the relay switches when the warning is present.

16 Multicluster Operation

16.1 Communication between the Sunny Island Inverters

For increased output, up to four Sunny Island clusters can be interconnected to form a Multicluster system. A Multicluster Box for Sunny Island 4548-US / 5048-US / 6048-US (MCB-12U) is required for such systems. Within each cluster, a communication interface connects the master to the slaves. Each cluster is connected to the others via another communication interface connected to the respective master.

The Multicluster Piggy-Back (MC-PB) is plugged into the Sunny Island at the external communication slot. The scope of delivery of the Multicluster Piggy-Back includes a grounding cable. Lay the grounding cable (B) as illustrated in the following figure:

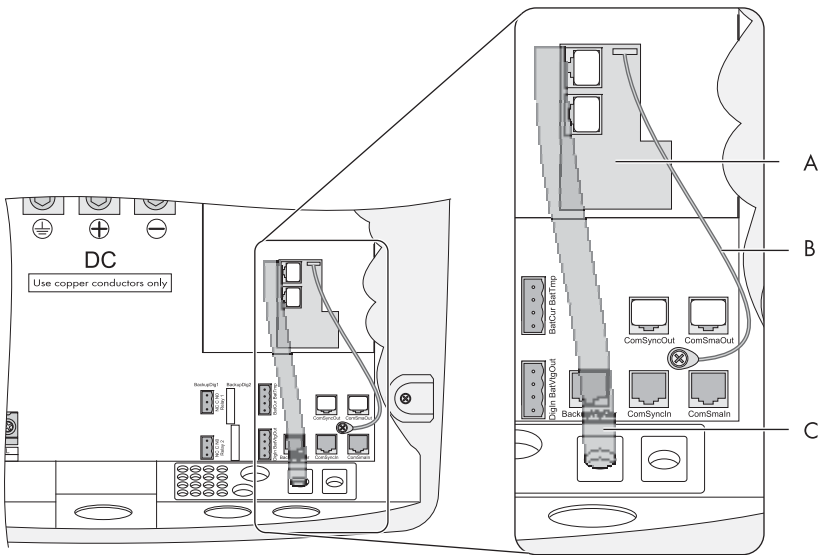

Position	Description
A	Multicluster Piggy-Back (MC-PB)
B	Grounding cable connection
C	Cable route

i Electrostatic Discharge

Electrostatic discharges are an acute danger to the Sunny Island and to the communication interface.

- Ground yourself before removing the communication interface from the packaging, and before touching any components within the Sunny Island. To achieve this, touch PE.

i RJ45 cable

The RJ45 data cable is a standard Cat5e-FTP cable (simple shielding), with gold contacts. Each Multicluster Piggy-Back (MC-PB) is delivered with one yellow and one gray RJ45 data cable and two plugs (terminators).

You require the yellow cable to establish communication between the master of the main cluster and the masters of the extension clusters.

The gray cable is used for external communication (via RS485) needed for the system monitoring (Sunny WebBox).

i Multicluster Piggy-Back

If just one cluster is used in connection with a Multicluster Box, a Multicluster Piggy-Back is not necessary.

Proceed as follows when connecting the data cable:

1. Remove the left of the two plugs from the cable support sleeve.
2. Feed the RJ45 cable from the outside through the plugs inside the Sunny Island master.
3. Plug the RJ45 plug in the lower pin connector. The termination resistor remains plugged in the upper one.
4. Lead the RJ45 cable into the next Sunny Island and connect it to the upper pin connector there.
5. Insert the terminator into the lower pin connector if no other Sunny Island will be connected.
6. Wrap the rubber plug (depending on the number of cables with one or two feed-throughs) around the RJ45 cable.
7. Plug the plug back into the designated opening in the cable support sleeve.

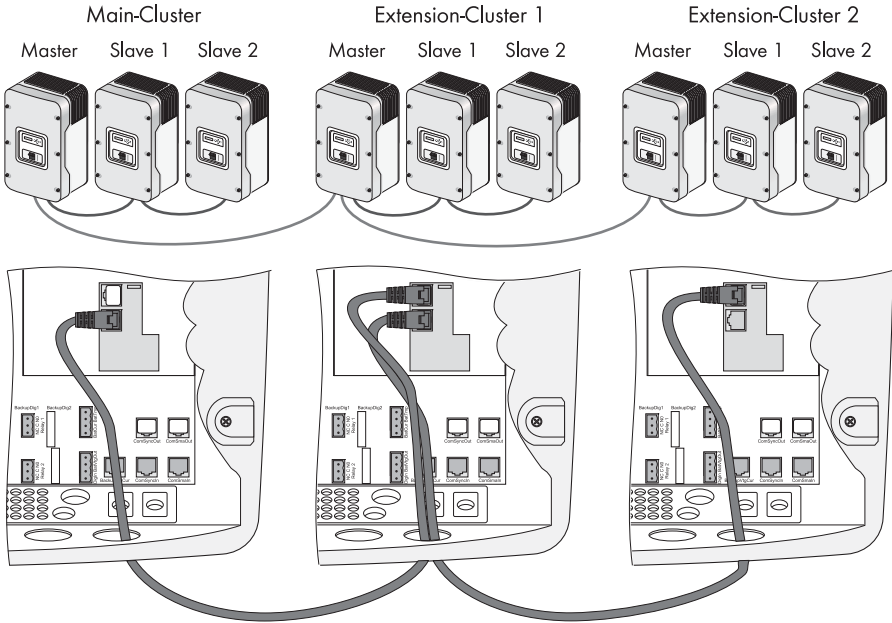

16.2 Commissioning the Multiclustet System

i Possible load shedding during initial start-up of a multiclustet system

Unwanted load shedding can occur during the initial start-up of a multiclustet system. The possible causes of this can be a too-low state of charge of the battery or a still too inaccurate charge level calculation in the Sunny Island.

- Disconnect all loads before the initial start-up of a multiclustet system.
 - After initial start-up, observe the SOC on the master of the main cluster via the parameter "120.01 BatSoc". As soon as the SOC has risen above 50%, connect the loads.
1. Perform steps 1 to 3 of the QCG start (see Section 8.2 "Starting the Quick Configuration Guide (QCG)", page 69).
 2. The following parameters must be set when "**New Battery**" is selected:
 - Device type (master, slave 1, slave 2, slave 3)
 - System configuration (3Phase, 1Phase 1, 1Phase 2, 1Phase 3, 2Phase 2, 2Phase 4, MC-Box), for multiclustet operation choose "MC-Box". Default setting: "1Phase 1"
 - Multiclustet configuration (MainCluster, ExtensionClst1, ExtensionClst2, ExtensionClst3), default setting: "MainCluster"
 - Device type of the Multiclustet Box (MC-Box-12), default setting: "MC-Box-12"
 3. For further settings, follow the QCG instructions (see Section 8.2 "Starting the Quick Configuration Guide (QCG)", page 69).

16.3 Switching a Multicuster System On and Off

16.3.1 Switching On/Starting

Switching on a Multicuster system can only take place at the master of the main cluster. The extension clusters will be started automatically after starting the main cluster. To do this, the DC circuit breakers of all Sunny Island inverters in the extension cluster must be set to "ON".

Proceed as follows:

1. Perform steps 1 to 4 of the start-up procedure on the master of the main cluster (see Section 9.1 "Switching On", page 75).

- The masters of the extension clusters show the following message:

```
STNDBY: Waiting
for Main Master
```

2. Press and hold <ENTER> on the main cluster master.

- The remaining time is displayed as a bar.

```
Hold to start...
■■■■■■■■■■
```

- An acoustic signal sounds. The main master is on and in operation. The green LED is glowing.

Starting the Multicuster system

The Multicuster system is started once the main master has started. All extension clusters follow the main master.

Error occurrence

If the Sunny Island displays an error message, this must be remedied before the Sunny Island is commissioned (see Section 20 "Troubleshooting", page 204).

16.3.2 Stopping and Switching Off

The Sunny Island Multicuster system can only be stopped at the master of the main cluster. Proceed at the master of the main cluster as described in Sections (see Section 9.2 "Stopping the Sunny Island (Standby)", page 76) and (see Section 9.3 "Switching Off", page 76).

16.3.3 Load Shedding in a Multicuster System

The load-shedding contactor in the Multicuster Box is controlled depending on the state of charge of the batteries.

Significance of the SOC thresholds:

When the state of charge of a battery reaches the lower SOC threshold, the load contactor is opened. The state of charge of the battery of the main cluster and the states of charge of the batteries of the extension clusters are evaluated. The load contactor disconnects the loads from the stand-alone grid. When the state of charge of all batteries reaches the upper SOC threshold during recharging, the load contactor closes. The load-shedding contactor connects the loads to the stand-alone grid.

The load shedding of the Multicuster Box only reacts to the SOC value of the main cluster.

1. Select the parameter "242.01 Lod1SocTm1Str" and set it to the lower SOC threshold.
2. Select the parameter "242.02 Lod1SocTm1Stp" and set it to the upper SOC threshold. The upper SOC threshold must be at least 10 percentage points above the lower SOC threshold.
3. Set the parameter "242.05 Lod1Tm1Str" and the parameter "242.06 Lod1Tm2Str" each to the same value, e.g. to 000000. This will switch the time-dependent load shedding off.

16.4 Generator Operation

The generator request of the main master comprises its own request (based on SOC, time, etc.) and possible requests from one or more extension clusters. The generator remains in a requested state as long as a request is present.



Generator request

The determined generator request at the extension clusters is transferred to the main master via a communication connection.

16.5 Behavior with Different States of Charge

In Multicuster systems, each cluster has its own battery-storage system. To prevent the states of charge of the various battery storage systems from diverging over time, a function for equalization of the states of charge is integrated into the Sunny Island inverters. This distributes the power to all clusters, however, it is not always distributed identically. Instead, the cluster with the highest state of charge discharges the most power or charges the battery with the lowest power.

The differences in power depend on the difference in the state of charge and total 1% of the nominal power for each 1% of difference in the state of charge. Thus, when initial charge states differ, equalization of the states of charge over the course of time is ensured. If all batteries in the various clusters have the same capacity, the charge states should always be within a few percent of each other. Only if a fault occurs, or upon deliberate deactivation of individual clusters, can a greater imbalance arise, but even so, such an imbalance should also be equalized after one day at the latest.

i Nominal capacity of the battery storage systems

Ideally, the various battery banks should all have the same nominal capacity.

If the nominal capacity varies by up to 30%, a similar average state of charge is ensured via the equalization function. However, the smallest battery is then cycled more intensively. The nominal power and overload capacity are no longer the value of an individual device multiplied by the number of devices. Instead, it is 10% to 20% lower for the cluster with the smaller battery.

16.6 Testing Multicuster Communication

Enter the installer password in order to be able to select the parameters "510.08 TstClstCom" and "510.09 ClstComStt".

1. Using the parameter "510.08 TstClstCom" a communication test between the clusters can be started from each master device of a cluster. Only switch the master device of the extension cluster to "Transmit".
 2. Request the status of the test via the Parameter "510.09 ClstComStt" at each master, including the master at which the test was started.
- If the communication test is successful, the status "OK" appears on each master.

16.7 Automatic Frequency Synchronization

In multicuster operation, the automatic frequency synchronization can only be activated at the main master. This function is activated using the parameter "250.11 AfraEna".

16.8 Firmware Update

i Stopping the Sunny Island

It is recommended to stop the entire cluster network, and to deactivate the loads insofar as this is possible.

i DC Circuit Breaker

Do not activate the DC circuit breaker during update process.

Carry out the update on all masters of the individual clusters via an SD memory card. All extension masters must have completed their updates! The message shown on the right is displayed.

```
STNDBY: Waiting
for Main Master
```

After the update of the masters has been carried out, carry out an automatic update of the slaves.

i Starting the multicuster system

Start the system only after the firmware on all Sunny Island devices has been updated.

16.9 Error Handling in a Multicluster System

For Multicluster system operation, the entire main cluster is always required. If a device in the main cluster fails (master and/or slave), this causes the main cluster to stop.

If the main cluster is stopped – whether due to a fault, or otherwise – this causes the extension clusters to stop, and thus the entire Multicluster system.

For operation of an extension cluster, it is necessary that at least the master device (of the extension cluster) is in operation. If a slave device in the extension cluster fails, this does not cause the master device to stop.

The devices in an extension cluster are only started up if the respective device detects a voltage when starting.

16.10 Grid Operation

The multicluster system is not certified for grid-tie use.

16.11 Generator Emergency Operation

If a Multicluster system fails, manual operation via the generator is possible. For this purpose, the generator must be started manually, directly at the generator. As soon as a voltage is present, the Multicluster Box connects the generator through to the loads, without a Sunny Island being in operation.

17 PV Inverters

i PV inverters compatible with the Sunny Island

You will find the list with compatible PV inverters in the download area at www.SMA-America.com in the Technical Information "PV Inverters: Use of PV Inverters in Off-Grid Systems and Battery-Backup Systems North America and South America".

The following section provides information on the connection and configuration of the Sunny Boy in stand-alone grid systems.

The Sunny Island together with the Sunny Boy are optimized for battery-backup operation (grid-tied) and for "Off-Grid" use.

This section describes the parameter setting of the Sunny Boy for both kinds of application. In battery-backup operation, the parameter must be set to "Default" in accordance with UL 1741. In parallel grid operation, the Sunny Island automatically detects a power outage and automatically switches the Sunny Boy inverter to "Off-Grid" mode. To set up this arrangement, the Sunny Island and the Sunny Boy must be connected with a data cable and the parameter of the Sunny Boy inverters must be set according to this document. If the utility grid is activated, the Sunny Island switches back to grid-tie operation in accordance with "UL 1741".

i Interface for external communication in Sunny Island systems with the utility grid

If the utility grid is connected to the Sunny Island system as an external source, the RS485 communication between the Sunny Island and the PV inverters is necessary. For this, the following devices each need one RS485 interface:

- the Sunny Island (if there are several Sunny Island inverters, the Sunny Island master)
- each PV inverter

17.1 Connection to the Stand-Alone Grid (Protected Load Switch)

⚠ WARNING

Danger to life due to high voltages in the Sunny Island system. Death or serious injury possible due to electric shock

- Ensure that the entire connection area of the Sunny Island 4548-US / 6048-US is voltage-free before installing the Sunny Boy inverter.
- Observe the safety information (see Section 3 "Safety", page 26).

- Connect the Sunny Boy to the stand-alone grid in accordance with the Sunny Boy installation manual.
- Connect the AC sub-distribution to the AC1 terminals of the Sunny Island. This AC sub-distribution is where the PV inverter will be connected as well.
- You must set the corresponding parameters in the Sunny Boy to suit a stand-alone grid so that it works properly together with the Sunny Island. The required values for these settings are described in the next section.

17.2 Setting the Off-Grid Parameters

⚠ WARNING

Danger to life from back-feed into the utility grid in the event of grid failure

Once you set the Sunny Boy to stand-alone grid parameters, the device no longer complies with IEEE 929 and the IEEE 1547.

- Observe the locally applicable regulations.
- Consult the responsible power company.

Controlled battery charging is needed in an off-grid configuration. Therefore Sunny Boy inverters can reduce their feed-in power. This task is performed by an implemented "Frequency Shift Power Control" system (see Section 17.5 "Frequency-Shift Power Control (FSPC)", page 154).

To activate this function, you must first pre-configure the Sunny Boy via programming.

17.3 Configuration of the PV Inverters with a Communication Products



SMA Grid Guard code required to change grid-relevant parameters

To change grid-relevant parameters in the PV inverter after more than ten operating hours, you will need the SMA Grid Guard code.

- Install a communication product corresponding to the type of communication and the PV inverter used.
- Apply for an SMA Grid Guard code to change grid-relevant parameters (for an application for the SMA Grid Guard code, see the Certificate "Application for SMA Grid Guard Code" at www.SMA-America.com).

PV Inverters with RS485

You can configure PV inverters with RS485 using the following communication products:

- Sunny WebBox
- Sunny Boy Control
- Computer with Sunny Data/Sunny Data Control software

For PV inverters without RS485 Piggy-Back or RS485 data module, you will also need a service cable for data transmission (USB Service Interface, SMA order number: USBPBS).

PV Inverters with Speedwire

You can configure PV inverters with Speedwire using the following communication products:

- Sunny Explorer
- SMA Cluster Controller

PV Inverters with BLUETOOTH

You can configure PV inverters with BLUETOOTH using the following communication products:

- Sunny Explorer
- Sunny WebBox mit BLUETOOTH Wireless Technology

17.4 Parameter Settings of the PV Inverters

17.4.1 Configuration of the PV Inverters in Battery-Backup Systems

In a battery-backup system, the Sunny Island is connected to the utility grid and communicates with the PV inverters via RS485. Therefore, the following requirements must be met:

- The Sunny Island and each PV inverter must be equipped with an RS485 Piggy-Back or an RS485 data module.
- In a cluster, only the master of the Sunny Island inverters must be equipped with an RS485 Piggy-Back.
- All PV inverters must be configured for battery-backup operation (see Section 17.3 "Configuration of the PV Inverters with a Communication Products", page 151).

When the utility grid is present at the AC2 terminal of the Sunny Island, the Sunny Boy will display the message "Backupstate: Grid". When there is no utility grid present at the AC2 terminal of the Sunny Island, the Sunny Boy will display the message "Backupstate: Off-Grid". The RS485 communication bus needs to be verified if this change does not occur.

Settings for Battery-Backup Operation via RS485 (e.g. with Sunny WebBox)

The following table shows how battery-backup operation must be set during configuration of the PV inverters via RS485. The parameter name and the configurable value depend on the PV inverter being used.

Parameter name	Value
Either "Backup Mode"	Either "On all"
or	or
"Op.BckOpMod"	"OnAllPhs"

In battery-backup systems, you operate the PV inverters with the locally typical country data set for grid-tie PV systems in accordance with UL1741. If the parameter is set to "On all" or "OnAllPhs", the system meets the requirements as per UL1741.



PV inverters without battery-backup function

For PV inverters without battery-backup function, the country data set must be set to the locally typical value for grid-tie PV systems as per UL1741. The PV inverter is then configured for operation on the utility grid. In the event of a utility grid failure, the Sunny Island is unable to derate the PV inverters by means of FSPC (frequency-shift power control) (see Section 17.5, page 154). If there is an excessive supply of energy, the PV inverters will switch off.

17.4.2 Configuration of PV Inverters in Off-Grid Systems

The country data set must be set to stand-alone mode in off-grid systems.

You can order PV inverters configured for stand-alone mode or you can configure existing PV inverters for stand-alone mode (see Section 17.3 "Configuration of the PV Inverters with a Communication Products", page 151). During the first ten operating hours you can adjust the country data set for many PV inverters by means of rotary switches (see the manual of the PV inverter).

Setting the Country Data Set via RS485 (e.g. with Sunny WebBox)

The following table shows how the country data set must be set during configuration of the PV inverter via RS485. The parameter name and the configurable value depend on the PV inverter being used.

Parameter name	Value
Either "Default"	Either "Off-Grid"
or	or
"CntrySet"	depending on power frequency, "OFF-Grid50" for 50 Hz power frequency or "Off-Grid60" for 60 Hz power frequency

Setting the Country Data set via Speedwire or BLUETOOTH (e.g. with Sunny Explorer)

The following table shows how the country data set must be set during configuration of the PV inverters via Speedwire or BLUETOOTH. The country data set value depends on the PV inverter being used.

Parameter name	Value
Set country standard	Either "Island mode"
	or
	depending on power frequency, "Island mode 50" for 50 Hz power frequency or "Island mode 60" for 60 Hz power frequency

The parameter setting "OffGrid" automatically sets the following Sunny Boy parameters to the values below:

No.	Parameters	Short descr.	Value
1	Test current	mA	Off (MSD = 0)
2	Vac.Min	V	-12% $V_{AC\ Nom}^*$
3	Vac.Max	V	+10% $V_{AC\ Nom}^*$
4	Fac-delta- Lower range in which the Sunny Boy is active, based on f_0	Hz	-3.0 (starting from base frequency f_0)

No.	Parameters	Short descr.	Value
5	Fac-max+ Upper range where the Sunny Boy is active, based on f_0	Hz	+3.0 (starting from the base frequency f_0)
6	dFac-Max Max. rate of change	Hz/s	4
7	Fac-start delta Frequency increase in relation to f_0 , at which point the power adjustment via frequency begins	Hz	1 (starting from the base frequency f_0)
8	Fac-Limit delta Frequency increase based on f_0 , where the power control via frequency ends. The power of the Sunny Boy at this point is 0 W.	Hz	2 (starting from the base frequency f_0)

* $V_{ACNom} = 208\text{ V}/240\text{ V}/277\text{ V}$

This completes the stand-alone grid parameter settings for the Sunny Boy.

17.5 Frequency-Shift Power Control (FSPC)

This section describes the operating principles of the "power adjustment via frequency" (Frequency Shift Power Control - FSPC).

If Sunny Boy inverters are connected to the AC side of the off-grid system, the Sunny Island must be able to limit their output power. This situation can occur when, e.g. the Sunny Island battery is fully charged and the (solar) power available from the PV array exceeds the power required by the connected loads.

To prevent the excess energy from overcharging the battery, the Sunny Island 4548-US / 6048-US recognizes this situation and changes the frequency at the AC output. This frequency adjustment is analyzed by the Sunny Boy. As soon as the power frequency increases and exceeds a defined value " $f_{AC\text{ Start Delta}}$ ", the Sunny Boy limits its power accordingly.

This function is shown in the following figure:

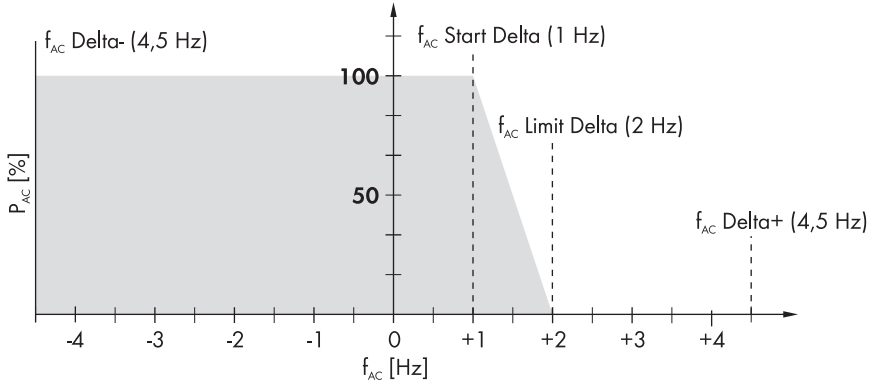

The different settings have the following meanings:

- f_0 refers to the base frequency of the stand-alone grid created by the Sunny Island.
- f_{AC} Delta- and f_{AC} Delta+ refer to the maximum range in which the Sunny Boy is active, based on, e.g. f_0 , 60 Hz.
- f_{AC} Start delta refers to the frequency increase relative to f_0 , at which point the frequency shift power control begins
- f_{AC} Limit delta refers to the frequency increase relative to f_0 , at which point the frequency shift power control stops. The power of the Sunny Boy at this point is 0 W.

If the thresholds " f_{AC} Delta-" is fallen below or if " f_{AC} Delta+" is exceeded, the Sunny Boy inverters disconnect from the stand-alone grid.

When FSPC is activated and the diesel generator in the off-grid power system is operating, the diesel generator determines the frequency, and the Sunny Boys react to certain changes in the diesel generator frequency. The diesel generators generally operate at 60 Hz under load. For this reason, in most cases the Sunny Boy inverters will deliver their entire power to the stand-alone grid, even when the generator is in operation.



Short-term increase of the frequency possible

If the current battery voltage (V_{Bat}) is greater than the nominal battery voltage ($V_{Bat, nom}$) and is also to be synchronized with an external source (generator), the Sunny Island temporarily increases the frequency and disconnects the Sunny Boy inverters using the frequency shutdown method (overfrequency). Afterwards, it synchronizes with the generator.

18 Maintenance and Care

The Sunny Island has been constructed for low maintenance. Thus, the necessary work is limited to only a few points.

18.1 Enclosure

Check that the Sunny Island enclosure is mechanically sound. If damage (e.g. cracks, holes, missing covers) endangers the operating safety, the Sunny Island must be deactivated immediately.

Larger particles of dirt should be removed from the device with a soft brush or similar item. Dust can be removed with a damp cloth. Do not use any solvents, abrasives or corrosive liquids for cleaning.

18.2 Cleaning the Fans

The cleaning intervals depend on the ambient conditions. If the fans are covered with loose dust, you can clean them with the aid of a vacuum cleaner (recommended) or a soft paint brush/hand brush. Clean the fans only when they are at a standstill. If it is necessary to replace the fans, contact your installer.

18.3 Display

It is best to clean the control elements with a soft, damp cloth. Do not use any solvents, abrasives or corrosive liquids for cleaning.

Take care not to accidentally press the membrane buttons during cleaning. Only clean the membrane keypad when the Sunny Island is deactivated.

18.4 Function

Check regularly whether error messages are present. If an error message is displayed, for which you cannot identify any apparent cause, the off-grid power system must be inspected by an installer. To ensure optimum operation, the operator should regularly check the Sunny Island entries in the error list at short intervals (monthly, or even weekly), especially during the first months after commissioning. This can help to discover hidden faults in the installation or errors in the configuration.

18.5 Battery

⚠ WARNING

Danger to life due to incompatible lithium-ion battery

An incompatible lithium-ion battery can lead to a fire or an explosion. Use of incompatible lithium-ion batteries can also make the user's battery management system unsafe, and void manufacturers' warranties. To avoid fire or explosion, we strongly recommend doing the following:

- Verify that the battery complies with locally applicable standards and directives, and is intrinsically safe.
- Verify that the particular lithium-ion battery type is approved for use with the SMA Sunny Island inverter (please see "List of Approved Lithium-Ion Batteries" under the Technical Information tab at www.SMA-America.com).
- If manufacturer approved Sunny Island lithium-ion batteries are not available, you may use lead acid batteries.

Inspect and maintain the battery at regular intervals. In this regard, observe all of the battery manufacturer's specifications.

Immediately replace the defective batteries.

18.6 Disposal

Dispose of the Sunny Island at the end of its electrical endurance in accordance with the disposal regulations for electronic waste which apply at the installation site at that time. Alternatively, send the devices back to SMA with shipping paid by sender, and labeled with the information "FOR DISPOSAL" (see Section 25 "Contact", page 242).

19 Parameter Lists

Only parameters in the menu branches "200 Settings" and "500 Operation" can be changed. All other values are only shown on the display of the SI 4548-US-10 / 6048-US-10. All menu items that can only be changed by the installer using a password are shaded in gray in the following tables.



Menu structure depends on system configuration

Depending on the set system configuration, individual menu items may be missing.



Interference during operation due to incorrect parameter settings

Use caution when setting parameters. Incorrect settings can lead to faulty operation of the inverter. Take note of the original values of all parameters that you change.

19.1 Display Values

19.1.1 Inverter Meters (110#)

111# Inverter Total Meters

No.	Name	Description
01	TotInvPwrAt	Total active power of the inverters (cluster) in kW
02	TotInvCur	Total current of the inverters (cluster) in A
03	TotInvPwrRt	Total reactive power of the inverters (cluster) in kVAr

112# Inverter Device Meters

No.	Name	Description	Value clear text (No.)	Explanation
01	InvOpStt	Operating state of the Sunny Island	Standby (2)	Standby
			Run (3)	Operation
			Run (4)/ EmCharge	Emergency charge mode
			Error (5)	Error
			Manual (6)	Manual Operation
			Startup (7)	Transfer standby > operation
02	InvPwrAt	Active power Sunny Island in kW		
03	InvVtg	Voltage of the Sunny Island in V		
04	InvCur	Current of the Sunny Island in A		

No.	Name	Description	Value clear text (No.)	Explanation
05	InvFrq	Frequency of the Sunny Island in Hz		
06	InvPwrRt	Reactive power of the Sunny Island in kVAr		
07	Rly1Stt	State of relay 1	Off On	Relay open Relay closed
08	Rly2Stt	State of relay 2	Off On	Relay open Relay closed

113# Inverter Slave1 Meters

No.	Name	Description	Value clear text (No.)	Explanation
01	InvOpSttSlv1	Operating state of slave 1	Standby (2) Run (3) EmCharge (4) Error (5) Manual (6) Startup (7)	Standby Operation Emergency charge mode Error Manual Operation Transfer standby > operation
02	InvPwrAtSlv1	Active power of slave 1 in kW		
03	InvVtgSlv1	Voltage of slave 1 in V		
04	InvCurSlv1	Current of slave 1 in A		
05	InvPwrRtSlv1	Reactive power of slave 1 in kVAr		
06	Rly1SttSlv1	State of relay 1 on slave 1	Off On	Relay open Relay closed
07	Rly2SttSlv1	State of relay 2 on slave 1	Off On	Relay open Relay closed

114# Inverter Slave2 Meters

No.	Name	Description	Value clear text (No.)	Explanation
01	InvOpSttSlv2	Operating state of slave 2	Standby (2)	Standby
			Run (3)	Operation
			EmCharge (4)	Emergency charge mode
			Error (5)	Error
			Manual (6)	Manual Operation
			Startup (7)	Transfer standby > operation
			02	InvPwrAtSlv2
03	InvVtgSlv2	Voltage of slave 2 in V		
04	InvCurSlv2	Current of slave 2 in A		
05	InvPwrRtSlv2	Reactive power of slave 2 in kVAR		
06	Rly1SttSlv2	State of relay 1 on slave 2	Off	Relay open
			On	Relay closed
07	Rly2SttSlv2	State of relay 2 on slave 2	Off	Relay open
			On	Relay closed

115# Inverter Slave3 Meters

No.	Name	Description	Value clear text (No.)	Explanation
01	InvOpSttSlv3	Operating state of slave 3	Standby (2)	Standby
			Run (3)	Operation
			EmCharge (4)	Emergency charge mode
			Error (5)	Error
			Manual (6)	Manual Operation
			Startup (7)	Transfer standby > operation
			02	InvPwrAtSlv3
03	InvVtgSlv3	Voltage of slave 3 in V		

No.	Name	Description	Value clear text (No.)	Explanation
04	InvCurSlv3	Current of slave 3 in A		
05	InvPwrRtSlv3	Reactive power of slave 3 in kVAr		
06	Rly1SttSlv3	State of relay 1 on slave 3	Off On	Relay open Relay closed
07	Rly2SttSlv3	State of relay 2 on slave 3	Off On	Relay open Relay closed

19.1.2 Battery Meters (120#)

No.	Name	Description	Value clear text (No.)	Explanation
01	BatSoc	Momentary battery state of charge (SOC) in %		
02	BatVtg	Battery voltage in V		
03	BatChrgVtg	Charging voltage target value in V		
04	AptTmRmg	Remaining absorption time in hours, minutes and seconds		
05	BatChrgOp	Active charging process	Boost (1) Full (2) Float (3; 7) Equalize (4; 5) Silent (6; 8)	Fast charge Full charge Float charge Equalization charge Silent mode
06	TotBatCur	Total battery current of the cluster in A		Negative values indicate charging, positive values indicate discharging.
07	BatTmp	Battery temperature in °C		
08	RmgTmFul	Remaining time until next full charge in days		

No.	Name	Description	Value clear text (No.)	Explanation
09	RmgTmEqu	Remaining time until next equalization charge in days		
10	AptPhs	Status of the absorption phase	Off (1) On (2)	Absorption phase not active Absorption phase is active
11	BatSocErr	Estimated error of the state of charge in %		Estimated error of the displayed state of charge in relation to the actual state of charge of the battery in percent (e.g. +/- 3%).
12	BatCpyThrpCnt	Nominal energy throughputs of the battery		

19.1.3 External Meters (130#)

131# Total Meters

No.	Name	Description
01	TotExtPwrAt	Total active power of the external source in kW
02	TotExtCur	Total current of the external source in A
03	TotExtPwrRt	Total reactive power in kVA
04	TotLodPwr	Total average active power of the loads (cluster) in kW
05	TotMccLodPwr	Total average active power of the loads (Multicluster) in kW

132# Grid State

No.	Name	Description
01	GdRmgTm	Remaining time of parameter "GdValTm" in hours, minutes and seconds

133# Generator State

No.	Name	Description	Value clear text (No.)	Explanation
01	GnDmdSrc	Source for generator request	None (1)	No request
			Bat (2)	Dependent on battery state of charge
			Lod (3)	Load-dependent
			Tim (4)	Time-controlled
			Run 1h (5)	Requested for 1 hour
			Start (6)	Manually started
			ExtSrcReq (7)	Requested via an external source
02	GnStt	Generator state	Off (1)	Off
			Init (2)	Init
			Ready (3)	Waiting for request (ready)
			Warm (4)	Warming up
			Connect (5)	Connecting
			Run (6)	Operation
			Retry (7)	Restarting
			Disconnect (8)	Split
			Cool (9)	Cooling down
			Lock (10)	Locked after error
			Fail (11)	Error
			FailLock (12)	Locked after error occurred.
03	GnRmgTm	Remaining time of the generator (minimum run time) in hours, minutes and seconds		
04	GnRnStt	Status generator feedback on the master	Off (1)	off
			On (2)	on

134# Device Meters

No.	Name	Description
01	ExtPwrAt	Active power of the external source in kW
02	ExtVtg	Voltage of the external source in V
03	ExtCur	Current of the external source in A
04	ExtFrq	Frequency of the external source in Hz
05	ExtPwrRt	Reactive power of the external source in kVAr

135# Slave1 Meters

No.	Name	Description
01	ExtPwrAtSlv1	Active power of the external source slave 1 in kW
02	ExtVtgSlv1	Voltage of the external source slave 1 in V
03	ExtCurSlv1	Current of the external source slave 1 in A
04	ExtPwrRtSlv1	Reactive power of the external source slave 1 in kVAr

136# Slave2 Meters

No.	Name	Description
01	ExtPwrAtSlv2	Active power of the external source slave 2 in kW
02	ExtVtgSlv2	Voltage of the external source slave 2 in V
03	ExtCurSlv2	Current of the external source slave 2 in A
04	ExtPwrRtSlv2	Reactive power of the external source slave 2 in kVAr

137# Slave3 Meters

No.	Name	Description
01	ExtPwrAtSlv3	Active power of the external source slave 3 in kW
02	ExtVtgSlv3	Voltage of the external source slave 3 in V
03	ExtCurSlv3	Current of the external source slave 3 in A
04	ExtPwrRtSlv3	Reactive power of the external source slave 3 in kVAr

138# Chp Meters (Combined Heat and Power)

No.	Name	Description	Value	Explanation
01	ChpStt	State of CHP plant	Idle	Off
			Run	Operation
			Lock	Locked after operation
02	ChpPwrAt	Power of the CHP plant		
03	ChpRmgTm	Remaining time of the CHP plant (minimum run time) in hours, minutes and seconds		
04	ChpStrRmgTm	Remaining time of the power request of the CHP plant in hours, minutes and seconds		

19.1.4 Charge Controller (140#)(not UL-certified)

Visibility of parameters in menu 140#

The parameters in menu 140# are only visible, if at least one Sunny Island Charger is connected to the system.

141# SIC50 Total

No.	Name	Description
01	TotSicEgyCntIn	Total energy of all Sunny Island Chargers in kWh
02	TotSicDyEgyCntIn	Total daily yield of all Sunny Island Chargers in kWh
03	TotSicPvPwr	Total PV power of all Sunny Island Chargers in W
04	TotSicBatCur	Total battery current of all Sunny Island Chargers in A

142# SIC50 1

No.	Name	Description
01	Sic1EgyCntln	Energy of the first Sunny Island Charger in kWh
02	Sic1TdyEgyCntln	Daily yield of the first Sunny Island Charger in kWh
03	Sic1PvPwr	PV power of the first Sunny Island Charger in W
04	Sic1PvVtg	PV voltage of the first Sunny Island Charger in V
05	Sic1BatVtg	Battery voltage of the first Sunny Island Charger in V
06	Sic1BatCur	Battery current of the first Sunny Island Charger in A
07	Sic1HsTmp	Heat sink temperature of the first Sunny Island Charger in °C
08	Sic1SWVers	Software version of the first Sunny Island Charger

143# SIC50 2

No.	Name	Description
01	Sic2EgyCntln	Energy of the second Sunny Island Charger in kWh
02	Sic2TdyEgyCntln	Daily yield of the second Sunny Island Charger in kWh
03	Sic2PvPwr	PV power of the second Sunny Island Charger in W
04	Sic2PvVtg	PV voltage of the second Sunny Island Charger in V
05	Sic2BatVtg	Battery voltage of the second Sunny Island Charger in V
06	Sic2BatCur	Battery current of the second Sunny Island Charger in A
07	Sic2HsTmp	Heat sink temperature of the second Sunny Island Charger in °C
08	Sic2SWVers	Software version of the second Sunny Island Charger

144# SIC50 3

No.	Name	Description
01	Sic3EgyCntln	Energy of the third Sunny Island Charger in kWh
02	Sic3TdyEgyCntln	Daily yield of the third Sunny Island Charger in kWh
03	Sic3PvPwr	PV power of the third Sunny Island Charger in W
04	Sic3PvVtg	PV voltage of the third Sunny Island Charger in V
05	Sic3BatVtg	Battery voltage of the third Sunny Island Charger in V
06	Sic3BatCur	Battery current of the third Sunny Island Charger in A
07	Sic3HsTmp	Heat sink temperature of the third Sunny Island Charger in °C

No.	Name	Description
08	Sic3SWVers	Software version of the third Sunny Island Charger

145# SIC50 4

No.	Name	Description
01	Sic4EgyCntln	Energy of the fourth Sunny Island Charger in kWh
02	Sic4TdyEgyCntln	Daily yield of the fourth Sunny Island Charger in kWh
03	Sic4PvPwr	PV power of the fourth Sunny Island Charger in W
04	Sic4PvVtg	PV voltage of the fourth Sunny Island Charger in V
05	Sic4BatVtg	Battery voltage of the fourth Sunny Island Charger in V
06	Sic4BatCur	Battery current of the fourth Sunny Island Charger in A
07	Sic4HsTmp	Heat sink temperature of the fourth Sunny Island Charger in °C
08	Sic4SWVers	Software version of the fourth Sunny Island Charger

19.2 Adjustable Parameters

19.2.1 Inverter Settings (210#)

No.	Name	Description	Value	Explanation	Default value
01	InvVtgNom	Nominal voltage of the Sunny Island		120 V / 60 Hz	120 V
02	InvChrgCurMax	Maximum AC charging current		SI 4548-US-10 SI 6048-US-10	37.5 A 48 A
03	InvFrqNom	Nominal frequency of the Sunny Island		120 V / 60 Hz	60 Hz

19.2.2 Battery Settings (220#)

221# Battery Property

No.	Name	Description	Value	Explanation	Default value
01	BatTyp	Battery type	VRLA	Lead-acid battery with immobilized electrolyte in gel or AGM (Absorbent Glass Mat Separator)	VRLA
			FLA	Valve-regulated lead-acid battery with liquid electrolyte	
			NiCd	Nickel-cadmium battery	
			Lilon_Ext-BMS	Lithium-ion battery	
02	BatCpyNom	Nominal battery capacity	100 Ah to 10,000 Ah	VRLA/FLA/NiCd	100 Ah
			50 Ah to 10,000 Ah	Lilon_Ext-BMS	
03	BatVtgNom	Nominal battery voltage		VRLA	48 V
				FLA	48 V
				NiCd	45.6 V
04	BatTmpMax	Max. battery temperature	104°F to 122°F (40°C to 50°C)		113°F (45°C)
05	BatTmpStr	Battery start temperature following stop due to overtemperature	32°F to 104°F (0°C to 40°C) "BatTmpMax"		104°F (40°C)
06	BatWirRes	Power resistor of the battery connection in mOhm	0 mOhm to 50 mOhm		
07	BatFanTmpStr	Starting temperature for the "BatFan" function			104°F (40°C)

#222 Battery Charge Mode

No.	Name	Description	Value	Explanation	Default value
01	BatChrgCurMax	Charging current of the battery	10 A to 1,200 A		61 A
02	AptTmBoost	Absorption time for normal charge	1 min to 600 min	VRLA	120 min
			1 min to 600 min	FLA	90 min
			1 min to 600 min	NiCd	300 min
03	AptTmFul	Absorption time for full charge	1 h to 20 h	VRLA	5 h
			1 h to 20 h	FLA	5 h
			1 h to 20 h	NiCd	7 h
04	AptTmEqu	Absorption time for equalization charge	1 h to 48 h		10 h
05	CycTmFul	Cycle time of full charge	1 day to 180 days		14 days
06	CycTmEqu	Equalization charge cycle time	7 days to 365 days		180 days
07	ChrgVtgBoost	Cell voltage setpoint for normal charge	2.2 V to 2.7 V	VRLA	2.40 V
				FLA	2.55 V
			1.5 V to 1.8 V	NiCd	1.65 V
08	ChrgVtgFul	Cell voltage setpoint for full charge	2.3 V to 2.7 V	VRLA	2.40 V
				FLA	2.50 V
			1.5 V to 1.8 V	NiCd	1.65 V
09	ChrgVtgEqu	Cell voltage setpoint for equalization charge	2.3 V to 2.7 V	VRLA	2.40 V
				FLA	2.50 V
			1.5 V to 1.8 V	NiCd	1.65 V
10	ChrgVtgFlo	Cell voltage setpoint for float charge	2.2 V to 2.4 V	VRLA	2.25 V
				FLA	2.25 V
			1.4 V to 1.6 V	NiCd	1.55 V

No.	Name	Description	Value	Explanation	Default value
11	BatTmpCps	Battery temperature compensation	0 mV/C° to 10 mV /°C	VRLA	4.0 mV/°C
				FLA	4.0 mV/°C
				NiCd	0 mV/°C
12	AutoEquChrgEn a	Automatic equalization charge	Disable	Disable	Enable
			Enable	Enable	

#223 Battery Protection

No.	Name	Description	Value	Default value
01	BatPro1TmStr	Starting time of the battery-preservation mode (level 1)		22:00:00
02	BatPro1TmStp	End time of the battery-preservation mode (level 1)		06:00:00
03	BatPro2TmStr	Starting time of the battery-preservation mode (level 2)		17:00:00
04	BatPro2TmStp	End time of the battery-preservation mode (level 2)		09:00:00
05	BatPro1Soc	State of charge for battery-preservation mode, level 1	0% to 70%	20%
06	BatPro2Soc	State of charge for battery-preservation mode, level 2	0% to 70%	15%
07	BatPro3Soc	State of charge for battery-preservation mode, level 3	0% to 70%	10%

#224 Battery Silent Mode

No.	Name	Description	Value	Explanation	Default value
01	SilentEna	Silent mode on utility grid	Disable	Disable	Disable
			Enable	Enable	
02	SilentTmFlo	Maximum time for float charge until transfer into silent mode	1 h to 48 h		3 h
03	SilentTmMax	Maximum time for silent until transfer into float	1 h to 168 h		12 h

225# Battery Current Sensor

No.	Name	Description	Value	Explanation	Default value
01	BatCurSnsTyp	Battery current sensor type	None	No sensor is connected.	None
			60 mV	Battery current sensor 60 mV	
			50 mV	Battery current sensor 50 mV	
02	BatCurGain60	External battery current sensor type (60 mV type)	0 A to 1,000 A		100 A/ 60 mV
03	BatCurGain50	External battery current sensor type (50 mV type)	0 A to 1,000 A		100 A/ 50 mV
04	BatCurAutoCal	Automatic calibration of external battery current sensor	Start	Start automatic calibration	

226# BMS Mode Basic / Off

No.	Name	Description	Value	Explanation	Default value
01	BatChrgVtgMan	Manual setpoint of the battery charging voltage with disabled battery management in V	41.0 V to 63.0 V		54.0 V
02	BatDiChgVtg	Minimum charging voltage of the battery	42 V to BatDiChgVtgStr		44 V
03	BatDiChgVtgStr	Start voltage after undervoltage detection	BatDiChgVtg to BatChrgVtgMan		48 V
04	BatRes	Internal resistance of the battery	0 mOhm to 200 mOhm		0 mOhm

19.2.3 External Settings (230#)

231# Ext General

No.	Name	Description	Value	Explanation	Default value
01	PvFeedTmStr	Start feed-in operation			04:00:00
02	PvFeedTmStp	Stop feed-in operation			22:00:00
03	ExtLkTm	Lock time after reverse power or relay protection	0 min to 60 min		20 min
05	ExtSrc	generator and grid operating mode	PvOnly Gen Grid GenGrid	PV only Generator Utility grid Generator/ utility grid	PvOnly
12	ChpEna	Combined heat and power plant	Disable Enable	Deactivated Activated	Disable

232# Grid Control

No.	Name	Description	Value	Explanation	Default value
01	GdVtgMin	Minimum grid voltage			105.6 V
02	GdVtgMax	Maximum grid voltage			132 V
03	GdCurNom	Nominal grid current			30 A
04	GdFrqNom	Nominal grid frequency			60 Hz
05	GdFrqMin	Minimum power frequency			59.3 Hz
06	GdFrqMax	Maximum power frequency			60.5 Hz
07	GdVldTm	Minimum time required for grid (voltage and frequency) to be within permissible range for connection			300 sec
08	GdMod	Grid interface	GridCharge	Charging on the utility grid	GdFeed
			GridFeed	Charge and feedback on the utility grid	
09	GdRvPwr	Permissible grid reverse power (active power)	0 W to 5,000 W		100 W
10	GdRvTm	Permissible time for grid reverse power	0 sec to 60 sec		5 sec
15	GdAISns	AI sensitivity	Low	Low	Normal
			Medium	Medium	
			Normal	Normal	
			High	High	
37	GdVtgIncProEna	Voltage increase protection	Disable	Disable	Disable
			Enable	Enable	
38	GdVtgIncPro	Limit for voltage increase protection			132 V
41	GdSocEna	Activate the grid request based on SOC	Disable	Disable	Disable
			Enable	Enable	

No.	Name	Description	Value	Explanation	Default value
42	GdPwrEna	Activate the grid request based on power	Disable	Disable	Disable
			Enable	Enable	

233# Grid Start

No.	Name	Description	Value	Explanation	Default value
01	GdSocTm1Str	SOC limit for switching on utility grid for time 1			40%
02	GdSocTm1Stp	SOC limit for switching off the utility grid for time 1			80%
03	GdSocTm2Str	SOC limit for switching on utility grid for time 2			40%
04	GdSocTm2Stp	SOC limit for switching off the utility grid for time 2			80%
05	GdTm1Str	Time 1 for grid request in hours, minutes and seconds Start: time 1, end: time 2			
06	GdTm2Str	Time 2 for grid request in hours, minutes and seconds Start: time 2, end: time 1			
07	GdPwrStr	Grid request starting capacity			4.0 kW
08	GdPwrStp	Grid request disconnection power limit			2.0 kW
09	GdStrChrgMod	Charge start when connecting to the grid	Off	off	Equal
			Full	Full charge	
			Equal	Equalization charge	
			Both	Full and equalization charge	

234# Generator Control

No.	Name	Description	Value	Explanation	Default value
01	GnVtgMin	Minimum generator voltage			80 V
02	GnVtgMax	Maximum generator voltage			150 V
03	GnCurNom	Nominal generator current			30 A
04	GnFrqNom	Nominal generator frequency at nominal load			60 Hz
05	GnFrqMin	Minimum generator frequency			54 Hz
06	GnFrqMax	Maximum generator frequency			66 Hz
07	GnStrMod	Generator interface	Manual Autostart GenMan	Manual Automatic SMA generator management box	Autostart
08	GnOpTmMin	Minimum run time of the generator			15 min
09	GnStpTmMin	Minimum stop time of the generator			15 min
10	GnCoolTm	Cooling time of the generator			5 min
11	GnErrStpTm	Stop time of generator in case of errors			1 h
12	GnWarmTm	Warm-up time			60 sec
13	GnRvPwr	Generator reverse power (active power)			100 W
14	GnRvTm	Permissible time for reverse power/reverse current			30 sec
15	GnCtlMod	Generator regulation	Cur CurFrq	Current Frequency	Cur

No.	Name	Description	Value	Explanation	Default value
20	GnAlSns	AI sensitivity	Low	Low	Normal
			Medium	Medium	
			Normal	Normal	
			High	High	
41	GnCurCtlMod	Enable I-Loop in generator mode	Droop (1)	Standard generator operation without I-Loop	Droop (1)
			CurCtl (2)	Current-controlled generator operation with I-Loop	

235# Generator Start

No.	Name	Description	Value	Explanation	Default value
01	GnAutoEna	Generator autostart	Off	Disable	On
			On	Enable	
02	GnAutoStr	Number of autostarts			3
03	GnSocTm1Str	SOC limit for switching on generator for time 1			40%
04	GnSocTm1Stp	SOC limit for switching off generator for time 1			80%
05	GnSocTm2Str	SOC limit for switching on generator for time 2			40%
06	GnSocTm2Stp	SOC limit for switching off generator for time 2			80%
07	GnTm1Str	Time 1 for generator request in hours, minutes and seconds Start: time 1, end: time 2			

No.	Name	Description	Value	Explanation	Default value
08	GnTm2Str	Time 2 for generator request in hours, minutes and seconds Start: time 2, end: time 1			
09	GnPwrEna	Generator request based on power	Off On	Disable Enable	Off
10	GnPwrStr	Generator request, connection power limit			4 kW
11	GnPwrStp	Generator request, disconnection power limit			2 kW
12	GnPwrAvgTm	Average time for power-related generator start			60 sec
13	GnTmOpEna	Time-controlled generator operation	Disable Enable	Disable Enable	Disable
14	GnTmOpStrDt	Starting date for time-controlled generator operation			2010-01-01
15	GnTmOpStrTm	Starting time for time-controlled generator operation in hours, minutes and seconds			
16	GnTmOpRnDur	Running time for time-controlled generator operation in hours, minutes and seconds			
17	GnTmOpCyc	Repeat cycle for time-controlled generator operation	Single Daily Weekly	One-time Daily Weekly	Single

No.	Name	Description	Value	Explanation	Default value
18	GnStrChrgMod	Generator start for charge type	Off	off	Both
			Full	Full charge	
			Equal	Equalization charge	
			Both	Full and equalization charge	
19	GnStrDigIn	Generator start upon signal at activated digital input. Based on the value at the input "DigIn", the Sunny Island decides whether to start or stop the generator. If the value of "DigIn" is at high level, the Sunny Island starts the generator. If the value of "DigIn" is at low level, the Sunny Island stops the generator.	Disable	Disable	Disable
			Enable	Enable	

236# CHP Control (Combined Heat and Power)

No.	Name	Description	Value	Explanation	Default value
01	ChpOpTmMin	Minimum run time of CHP plant			60 min
02	ChpStpTmMin	Minimum stop time of CHP plant			10 min
03	ChpPwrMax	Maximum power of CHP plant			5 kW
04	ChpPwrMin	Minimum power of CHP plant			2 kW
05	ChpFrqPwrMax	Maximum frequency of CHP plant			51 Hz
06	ChpFrqPwrMin	Minimum frequency of CHP plant			52 Hz
07	ChpFrqOff				53 Hz

237# CHP Start

No.	Name	Description	Value	Explanation	Default value
01	ChpSocTm1Str	SOC limit for switching on CHP plant for time 1			40%
02	ChpSocTm1Stp	Switch off SOC limit for CHP plant for time 1			80%
03	ChpSocTm2Str	SOC limit for switching on CHP plant for time 2			40%
04	ChpSocTm2Stp	Switch off SOC limit for CHP plant for time 2			80%
05	ChpTm1Str	Time 1 for CHP plant request in hours, minutes and seconds Start: time 1, end: time 2			
06	ChpTm2Str	Time 2 for CHP plant request in hours, minutes and seconds Start: time 2, end: time 1			

No.	Name	Description	Value	Explanation	Default value
07	ChpPwrEna	Activate CHP plant request based on power	Disable	Disable	Enable
			Enable	Enable	
08	ChpPwrStr	CHP plant request, connection power limit			4 kW
09	ChpPwrStrDly	Time delay for power request for CHP plant			5 min
10	ChpManStr	Manual CHP start	Auto	Automatic	Auto
			Start	Starting	
			Stop	Stopping	
11	ChpAddOnTm	Time activated for the additional CHP plant request			60 sec
12	ChpAddOffTm	Time deactivated for the additional CHP plant request			120 sec
13	ChpAddSocDel	Distance to the next SOC limit			5%

19.2.4 Relay Settings (240#)

241# Relay General

No.	Name	Description	Value	Explanation	Default value
01	Rly1Op	Function relay 1	Off	off	AutoGn
			On	on	
			AutoGn	Generator request	
			AutoLodExt	External loadshedding	
			AutoLod1Soc	SOC1 Loadshedding	
			AutoLod2Soc	SOC2 Loadshedding	
			Tmr1	Timer 1	
			Tmr2	Timer 2	
			AptPhs	Absorption phase	
			ExtPwrDer	External power reduction	
			GnRn	Generator in operation	
			ExtVfOk	External source (voltage and frequency OK)	
			GdOn	Utility grid connected	
			Error	Error	
			Warn	Warning	
			Run	Operation	
			BatFan	Battery fan (room)	
			AccCir	Acid circulation	
			MccBatFan	Multicluster battery room ventilator	
			MccAutoLod	Loadshedding	
			CHPReq	CHP plant request	
			CHPAdd	Additional CHP plant request	
			SiComRemote	SI Com module	
Overload	Overload				

No.	Name	Description	Value	Explanation	Default value
02	Rly2Op	Function relay 2	Off	off	AutoLod Ext
			On	on	
			AutoGn	Generator request	
			AutoLodExt	External loadshedding	
			AutoLod1Soc	SOC1 Loadshedding	
			AutoLod2Soc	SOC2 Loadshedding	
			Tmr1	Timer 1	
			Tmr2	Timer 2	
			AptPhs	Absorption phase	
			ExtPwrDer	External power reduction	
			GnRn	Generator in operation	
			ExtVfOk	External source (voltage and frequency OK)	
			GdOn	Utility grid connected	
			Error	Error	
			Warn	Warning	
			Run	Operation	
			BatFan	Battery fan (room)	
			AcdCir	Acid circulation	
			MccBatFan	Multicluster battery room ventilator	
			MccAutoLod	Loadshedding	
CHPReq	CHP plant request				
CHPAdd	Additional CHP plant request				
SiComRemote	SI Com module				
Overload	Overload				

No.	Name	Description	Value	Explanation	Default value
07	ExtPwrDerMinTm	Minimum time of external power reduction	0 min to 600 min		10 min
08	ExtPwrDerDltVtg	Differential voltage of external power reduction	0 V to 0.4 V		0.15 V

242# Relay Load

No.	Name	Description	Value	Explanation	Default value
01	Lod1SocTm1Str	SOC limit for load shedding 1 start for t1			30%
02	Lod1SocTm1Stp	SOC limit for load shedding 1 stop for t1			50%
03	Lod1SocTm2Str	SOC limit for load shedding 1 start for t2			30%
04	Lod1SocTm2Stp	SOC limit for load shedding 1 stop for t2			50%
05	Lod1Tm1Str	Time 1 for Loadshed 1 in hours, minutes and seconds Start: time 1, end: time 2			
06	Lod1Tm2Str	Time 2 for Loadshed 1 in hours, minutes and seconds Start: time 2, end: time 1			
07	Lod2SocTm1Str	SOC limit for load shedding 2 start for t1			30%
08	Lod2SocTm1Stp	SOC limit for load shedding 1 stop for t2			50%
09	Lod2SocTm2Str	SOC limit for load shedding 2 start for t2			30%
10	Lod2SocTm2Stp	SOC limit for load shedding 2 stop for t2			50%

No.	Name	Description	Value	Explanation	Default value
11	Lod2Tm1Str	Time 1 for Loadshed 2 in hours, minutes and seconds Start: time 1, end: time 2			
12	Lod2Tm2Str	Time 2 for Loadshed 2 in hours, minutes and seconds Start: time 2, end: time 1			

243# Relay Timer

No.	Name	Description	Value	Explanation	Default value
01	RlyTmr1StrDt	Start date for timer 1			2006-01-01
02	RlyTmr1StrTm	Start time for relay control timer 1 in hours, minutes and seconds			
03	RlyTmr1Dur	Running time for relay control timer 1 in hours, minutes and seconds			
04	RlyTmr1Cyc	Repetition cycle time for timer 1	Single Daily Weekly	One-time Daily Weekly	Single
05	RlyTmr2StrDt	Start date timer 2			2006-01-01
06	RlyTmr2StrTm	Start time for relay control timer 2 in hours, minutes and seconds			
07	RlyTmr2Dur	Running time for relay control timer 2 in hours, minutes and seconds			
08	RlyTmr2Cyc	Repetition cycle time for timer 2	Single Daily Weekly	One-time Daily Weekly	Single

244# Relay Slave1

No.	Name	Description	Value	Explanation	Default value
01	Rly1OpSlv1	Function of relay 1 on slave 1	Off	off	Off
			On	on	
			AutoGn	Generator request	
			AutoLodExt	External loadshedding	
			AutoLod1Soc	SOC1 Loadshedding	
			AutoLod2Soc	SOC2 Loadshedding	
			Tmr1	Timer 1	
			Tmr2	Timer 2	
			AptPhs	Absorption phase	
			ExtPwrDer	External power reduction	
			GnRn	Generator in operation	
			ExtVfOk	External source (voltage and frequency OK)	
			GdOn	Utility grid connected	
			Error	Error	
			Warn	Warning	
			Run	Operation	
			BatFan	Battery fan (room)	
			AcdCir	Acid circulation	
			MccBatFan	Multicluster battery room ventilator	
			MccAutoLod	Loadshedding	
			CHPReq	CHP plant request	
			CHPAdd	Additional CHP plant request	
			SiComRemote	SI Com module	
Overload	Overload				

No.	Name	Description	Value	Explanation	Default value
02	Rly2OpSlv1	Function of relay 2 on slave 1	Off	off	Off
			On	on	
			AutoGn	Generator request	
			AutoLodExt	External loadshedding	
			AutoLod1Soc	SOC1 Loadshedding	
			AutoLod2Soc	SOC2 Loadshedding	
			Tmr1	Timer 1	
			Tmr2	Timer 2	
			AptPhs	Absorption phase	
			ExtPwrDer	External power reduction	
			GnRn	Generator in operation	
			ExtVfOk	External source (voltage and frequency OK)	
			GdOn	Utility grid connected	
			Error	Error	
			Warn	Warning	
			Run	Operation	
			BatFan	Battery fan (room)	
			AcdCir	Acid circulation	
			MccBatFan	Multicluster battery room ventilator	
			MccAutoLod	Loadshedding	
			CHPReq	CHP plant request	
			CHPAdd	Additional CHP plant request	
			SiComRemote	SI Com module	
Overload	Overload				

245# Relay Slave2

No.	Name	Description	Value	Explanation	Default value
01	Rly1OpSlv2	Function of relay 1 on slave 2	Off	off	Off
			On	on	
			AutoGn	Generator request	
			AutoLodExt	External loadshedding	
			AutoLod1Soc	SOC1 Loadshedding	
			AutoLod2Soc	SOC2 Loadshedding	
			Tmr1	Timer 1	
			Tmr2	Timer 2	
			AptPhs	Absorption phase	
			ExtPwrDer	External power reduction	
			GnRn	Generator in operation	
			ExtVfOk	External source (voltage and frequency OK)	
			GdOn	Utility grid connected	
			Error	Error	
			Warn	Warning	
			Run	Operation	
			BatFan	Battery fan (room)	
			AcdCir	Acid circulation	
			MccBatFan	Multicluster battery room ventilator	
			MccAutoLod	Loadshedding	
			CHPReq	CHP plant request	
			CHPAdd	Additional CHP plant request	
			SiComRemote	SI Com module	
Overload	Overload				

No.	Name	Description	Value	Explanation	Default value
02	Rly2OpSlv2	Function of relay 2 on slave 2	Off	off	Off
			On	on	
			AutoGn	Generator request	
			AutoLodExt	External loadshedding	
			AutoLod1Soc	SOC1 Loadshedding	
			AutoLod2Soc	SOC2 Loadshedding	
			Tmr1	Timer 1	
			Tmr2	Timer 2	
			AptPhs	Absorption phase	
			ExtPwrDer	External power reduction	
			GnRn	Generator in operation	
			ExtVfOk	External source (voltage and frequency OK)	
			GdOn	Utility grid connected	
			Error	Error	
			Warn	Warning	
			Run	Operation	
			BatFan	Battery fan (room)	
			AcdCir	Acid circulation	
			MccBatFan	Multicluster battery room ventilator	
			MccAutoLod	Loadshedding	
			CHPReq	CHP plant request	
CHPAdd	Additional CHP plant request				
SiComRemote	SI Com module				
Overload	Overload				

246# Relay Slave3

No.	Name	Description	Value	Explanation	Default value
01	Rly1OpSlv3	Function of relay 1 on slave 3	Off	off	Off
			On	on	
			AutoGn	Generator request	
			AutoLodExt	External loadshedding	
			AutoLod1Soc	SOC1 Loadshedding	
			AutoLod2Soc	SOC2 Loadshedding	
			Tmr1	Timer 1	
			Tmr2	Timer 2	
			AptPhs	Absorption phase	
			ExtPwrDer	External power reduction	
			GnRn	Generator in operation	
			ExtVfOk	External source (voltage and frequency OK)	
			GdOn	Utility grid connected	
			Error	Error	
			Warn	Warning	
			Run	Operation	
			BatFan	Battery fan (room)	
			AcdCir	Acid circulation	
			MccBatFan	Multicluster battery room ventilator	
			MccAutoLod	Loadshedding	
			CHPReq	CHP plant request	
			CHPAdd	Additional CHP plant request	
			SiComRemote	SI Com module	
Overload	Overload				

No.	Name	Description	Value	Explanation	Default value
02	Rly2OpSlv3	Function of relay 2 on slave 3	Off	off	Off
			On	on	
			AutoGn	Generator request	
			AutoLodExt	External loadshedding	
			AutoLod1Soc	SOC1 Loadshedding	
			AutoLod2Soc	SOC2 Loadshedding	
			Tmr1	Timer 1	
			Tmr2	Timer 2	
			AptPhs	Absorption phase	
			ExtPwrDer	External power reduction	
			GnRn	Generator in operation	
			ExtVfOk	External source (voltage and frequency OK)	
			GdOn	Utility grid connected	
			Error	Error	
			Warn	Warning	
			Run	Operation	
			BatFan	Battery fan (room)	
			AcdCir	Acid circulation	
			MccBatFan	Multicluster battery room ventilator	
			MccAutoLod	Loadshedding	
CHPReq	CHP plant request				
CHPAdd	Additional CHP plant request				
SiComRemote	SI Com module				
Overload	Overload				

19.2.5 System Settings (250#)

No.	Name	Description	Value	Explanation	Default value
01	AutoStr	Autostart If the value 0 has been set, this means that the autostart is deactivated.			3
02	Dt	Date		MM/DD/YYYY	99.99.9999
03	Tm	Time in hours, minutes and seconds		HH:MM:SS	99:99:99
04	BeepEna	Button sound	Off On	Disable Enable	On
05	ClstCfgr	Cluster configuration	Slave 1 Slave2 Slave3 1Phase 1 1Phase2 1Phase3 1Phase4 2Phase2 2Phase4 3Phase MC-Box	Cluster slave 1 Cluster slave 2 Cluster slave 3 Single-phase, 1 Sunny Island Single-phase, 2 Sunny Island Single-phase, 3 Sunny Island Single-phase, 4 Sunny Island Split-phase, 2 Sunny Island Double split-phase, 4 Sunny Island Three-phase, 3 Sunny Island Setting for Multiclustere operation	1Phase 1

No.	Name	Description	Value	Explanation	Default value
06	ComBaud	Baud rate	1,200 4,800 9,600 19,200		1,200
09	ComAdr	Address for communication			1
10	SleepEna	Sleep mode	Disable Enable	Disable Enable	Enable
11	AfraEna	Tertiary control (automatic frequency synchronization)	Disable Enable	Disable Enable	Enable
13	SlpAtNgt	Switch off slaves at night	Disable Enable	Disable Enable	Disable
14	SlpStrTm	Start time for overnight shutdown (sleep mode)			20:00:00
15	SlpStpTm	Stop time for overnight shutdown (sleep mode)			05:00:00
23	Box	Type of Multicluster Box used		MCB-12U	MC-Box-12
24	ClstMod	Cluster type in Multicluster operation (system configuration)	SingleCluster MainCluster ExtensionClst1 ExtensionClst2 ExtensionClst3 ExtensionClstN		SingleCluster
25	ClstAdr	Cluster address			

No.	Name	Description	Value	Explanation	Default value
28	ChrgCtlOp	Typ of DC charging device	Auto	Automatic	Auto
			DCOnly	Battery charger only	
			SMA	Sunny Island Charger	
30	RnMod	"Run Mode"	RunAlways	Always available	RunAlways
		Behavior under fault conditions	StopAlways	Stop if device malfunctions	

19.2.6 Password Setting (280#)

Observe the information on entering the installer password (see Section 10.5 "Entering the Installer Password", page 88).

19.3 Diagnosis (300#)

19.3.1 Inverter Diagnosis (310#)

311# System Total Diagnosis

No.	Name	Description
01	EgyCntIn	Energy absorbed in kWh
02	EgyCntOut	Energy fed in kWh
03	EgyCntTm	Energy metering run time in hours

312# Inverter Device Diagnosis

No.	Name	Description	Value clear text (No.)	Explanation	Default value
01	Adr	Device address	Master (1)	Address	Master
			Slave1 (2)	Address	
			Slave2 (3)	Address	
			Slave3 (4)	Address	
02	FwVer	Firmware version of the master			
03	SN	Serial number of the master			

No.	Name	Description	Value clear text (No.)	Explanation	Default value
04	OnTmh	Operating hours of the Sunny Island in hours			
05	ClstCfgAt	Set cluster configuration The value is based on the setting in QCG			
06	OpStt	Operating state of the Sunny Island	Operating (1)	Operation	
			Warning (2)	Warning	
			Failure (3)	Error	
07	CardStt	SD memory card status message	Off (1)	none	Off
			Operational (2)	Busy	
			Mount (3)	Initialization	
			OutOfSpace (4)	No storage space available	
			BadFileSys (5)	No file system detected	
			Incomp (6)	Incompatible file system	
			Parameter (7)	Parameter set write access	
			ParamFailed (8)	Parameter set write access failed	
			WriteLogData (9)	Log data write access	
			WriteLogFailed (10)	Log data write access failed	
08	FwVer2	Firmware version DSP			
09	FwVer3	OCU boot loader			
10	FwVer4	DSP boot loader			

313# Inverter Slave1 Diagnosis

No.	Name	Description	Value	Explanation
01	FwVerSlv1	Firmware version of slave 1		
02	SNSlv1	Serial number of slave 1		
03	OnTmhSlv1	Operating hours of slave 1 in hours		
04	PhSlv1	Phase position of slave 1	L1	Line conductor L1
			L2	Line conductor L2
			L3	Line conductor L3
05	OpSttSlv1	Operating state of slave 1	Operating	Operation
			Warning	Warning
			Failure	Error
06	FwVer2Slv1	DSP firmware version of slave 1		
07	FwVer3Slv1	OCU boot loader of slave 1		
08	FwVer4Slv1	DSP boot loader of slave 1		

314# Inverter Slave2 Diagnosis

No.	Name	Description	Value	Explanation
01	FwVerSlv2	Firmware version of slave 2		
02	SNSlv2	Serial number of slave 2		
03	OnTmhSlv2	Operating hours of slave 2 in hours		
04	PhSlv2	Phase position of slave 2	L1	Line conductor L1
			L2	Line conductor L2
			L3	Line conductor L3
05	OpSttSlv2	Operating state of slave 2	Operating	Operation
			Warning	Warning
			Failure	Error

No.	Name	Description	Value	Explanation
06	FwVer2Slv2	DSP firmware version of slave 2		
07	FwVer3Slv2	OCU boot loader of slave 2		
08	FwVer4Slv2	DSP boot loader of slave 2		

315# Inverter Slave3 Diagnosis

No.	Name	Description	Value	Explanation
01	FwVerSlv3	Firmware version of slave 3		
02	SNSlv3	Serial number of slave 3		
03	OnTmhSlv3	Operating hours of slave 3 in hours		
04	PhSlv3	Phase position of slave 3	L1	Line conductor L1
			L2	Line conductor L2
			L3	Line conductor L3
05	OpSttSlv3	Operating state of slave 3	Operating	Operation
			Warning	Warning
			Failure	Error
06	FwVer2Slv3	DSP firmware version of slave 3		
07	FwVer3Slv3	OCU boot loader of slave 3		
08	FwVer4Slv3	DSP boot loader of slave 3		

19.3.2 Battery Diagnosis (320#)

No.	Name	Description	Value	Explanation	Default value
01	Soh	State of health (SOH) Ratio of current capacity to its nominal value			100%

No.	Name	Description	Value	Explanation	Default value
02	StatTm	Run time of statistics counter in days			
03	ChrgFact	Charging factor			1.00
04	BatEgyCntIn	Energy meter for battery charging in kWh			
05	BatEgyCntOut	Energy meter for battery discharge in kWh			
06	AhCntIn	Meter for battery charging ampere-hours			
07	AhCntOut	Meter for battery discharging ampere-hours			
08	BatTmpPkMin	Minimum battery temperature in °C			
09	BatTmpPkMax	Maximum battery temperature in °C			
10	EquChrgCnt	Equalization charge meter			
11	FulChrgCnt	Full charge counter			
12	BatCurOfsErr	Offset error of battery current in A			
13	OcvPointCnt	Meter for open-circuit voltage points			
15	AhCntFul	Ampere-hour meter for battery discharge since last full charge (in Ah/100 Ah)			
16	AhCntEqu	Ampere-hour meter for battery discharge since last equalization charge (in Ah/100 Ah)			
17	BatVtgPk	Maximum battery voltage to have arisen in V			

No.	Name	Description	Value	Explanation	Default value
18	BatCurPkIn	Maximum battery current in the charging direction (in A)			
19	BatCurPkOut	Maximum battery current in discharging direction (in A)			
20	SocHgm100	Frequency scale of state of charge in percent, 100% > SOC >= 90%			
21	SocHgm090	Frequency scale of state of charge in percent, 90% > SOC >= 80%			
22	SocHgm080	Frequency scale of state of charge in percent, 80% > SOC >= 70%			
23	SocHgm070	Frequency scale of state of charge in percent, 70% > SOC >= 60%			
24	SocHgm060	Frequency scale of state of charge in percent, 60% > SOC >= 50%			
25	SocHgm050	Frequency scale of state of charge in percent, 50% > SOC >= 40%			
26	SocHgm040	Frequency scale of state of charge in percent, 40% > SOC >= 30%			
27	SocHgm030	Frequency scale of state of charge in percent, 30% > SOC >= 20%			

No.	Name	Description	Value	Explanation	Default value
28	SocHgm020	Frequency scale of state of charge in percent, 20% > SOC >= 10%			
29	SocHgm010	Frequency scale of state of charge in percent, 10% > SOC >= 0%			
30	SocHgm000	Frequency scale of state of charge in percent SOC < 0%			
31	SocVtgCal	Recalibration of state of charge only via open-circuit voltage (in percent)			
32	ErrSocVtgCal	Estimated error of the voltage-calibrated state of charge			50%
33	SocChrgCal	Recalibration of state of charge only via full charge			50%
34	ErrSocChrgCal	Estimated error of the full charge calibrated state of charge			50%
35	OcvGra	Slope of the characteristic curve of the open-circuit voltage			700 Ah /V
36	OcvMax	Maximum open-circuit voltage			2.12 V

19.3.3 External Diagnosis (330#)

331# Grid Diagnosis

No.	Name	Description
01	GdEgyCntIn	Energy meter for grid feed-in in kWh
02	GdEgyCntOut	Energy meter for power taken from the grid in kWh
03	GdEgyTmh	Run time of energy meter for utility grid in hours
04	GdOpTmh	Operating hour meter for grid operation
05	GdCtcCnt	Counter for grid connections
06	ToiTmh	Feed-in hours

332# Generator Diagnosis

No.	Name	Description
01	GnEgyCnt	Generator energy meter in kWh
02	GnEgyTm	Running time of generator energy meter in hours
03	GnOpTmh	Operating hour meter for generator
04	GnStrCnt	Number of generator starts

19.4 Events, Warnings and Errors (History)

19.4.1 Failure/Event (400#)

Observe the information on the menus "410# Failures Current", "420# Failure History" and "430# Event History" (see Section 10.9 "Display of Warnings and Failures", page 93).

19.5 Functions in Operation

19.5.1 Operation (500#)

510# Operation Inverter

No.	Name	Description	Value	Explanation	Default value
01	InvRs	Trips a restart of the Sunny Island	Restart	Restart	
02	InvRmOpEna	Time-controlled inverter operation	Disable Enable	Disable Enable	Disable

No.	Name	Description	Value	Explanation	Default value
03	InvTmOpStrDt	Start date for time-controlled inverter operation			2006-01-01
04	InvTmOpStrTm	Start time for time-controlled inverter operation in hours, minutes and seconds		Value can be set freely	
05	InvTmOpRnDur	Running time for time-controlled inverter operation in hours, minutes and seconds		Value can be set freely	
06	InvTmOpCyc	Repetition cycle for time-controlled inverter operation (Tm1)	Single	One-time	Single
			Daily	Daily	
			Weekly	Weekly	
07	CntRs	Delete energy meter The value indicates which energy meter is to be deleted.	Inv	Sunny Island	
			Bat	Battery	
			Gn	Generator	
			Gd	Utility grid	
			All	All energy meters	
			Sic1	Sunny Island Charger 1	
			Sic2	Sunny Island Charger 2	
			Sic3	Sunny Island Charger 3	
			Sic4	Sunny Island Charger 4	
SicAll	All Sunny Island Chargers				
08	TstClstCom	Activates the communication test between the individual clusters:	Off	off	
			Transmit	Enable	
09	ClstComStt	Communication test status	Wait	Wait	
			OK	Completed	

No.	Name	Description	Value	Explanation	Default value
10	FrcClstUpd	Manual update of the cluster	UpdateClst	Cluster update (OCU & DSP)	
			UpdateClstBFR	Cluster update (OCU)	
			UpdateClstDSP	Cluster update (DSP)	

520# Operation Battery

No.	Name	Description	Value	Explanation	Default value
01	ChrgSelMan	Manual equalization charge	Idle	Wait	Idle
			Start	Starting	
			Stop	Stopping	

540# Operation Generator

No.	Name	Description	Value	Explanation	Default value
01	GnManStr	Manual generator start	Auto	Automatic	Auto
			Stop	Stopping	
			Start	Starting	
			Run 1h	Run for 1 h	
02	GnAck	Error confirmation for generator error	Ackn	Failure confirmation	

550# Operation MMC

No.	Name	Description	Value	Explanation	Default value
01	ParaSto	Save parameter settings	Set1	Parameter Set1	
			Set2	Parameter Set2	
02	ParaLod	Load parameter settings	Set1	Parameter Set1	
			Set2	Parameter Set2	
			Factory	Load default settings	

No.	Name	Description	Value	Explanation	Default value
03	CardFunc	Functions of the SD memory card	ForcedWrite	Forced write	
			StoEvtHis	Save event memory	
			StoFailHis	Save error log	
			StoHis	Storing event and fault memory	
04	DatLogEna	Automatic data storage	Off	Disable	On
			On	Enable	

560# Operation Grid

The 560# Operation Grid menu can only be seen if the external voltage source of the Sunny Island is set to "Grid" or "GenGrid".

No.	Name	Description	Value	Explanation	Default value
01	GdManStr	Manual grid start	Auto	Automatic	Auto
			Stop	Stopping	
			Start	Starting	

19.6 Direct Access to the Parameters

19.6.1 Direct Access (600#)

Observe the information for the direct accessing of the parameters (see Section 10.3 "Direct Access - Direct Access to the Parameters", page 84).

20 Troubleshooting

In general, the Sunny Island distinguishes between events and errors.

- **Events** describe state changes or transient states (e.g. generator connection).
- **Errors** describe states that are not permitted or are only permitted up to a certain rate. This includes warnings, disturbances and errors. User interaction is generally required.

20.1 Error Acknowledgement

If a disturbance or error occurs, the Sunny Island goes into standby.

Proceed as follows to acknowledge an error:

1. Eliminate the cause.
2. Confirm error with <ENTER>.
3. Start the Sunny Island again.

20.2 Autostart Handling

The Sunny Island has an autostart meter which counts down by 1 with every automatic start. If the Sunny Island runs uninterrupted for over ten minutes, the autostart meter is reset to its initial value.

If another fault occurs when the autostart meter is at 0, the Sunny Island waits for ten minutes and then attempts to restart. The autostart meter begins to run again.

The number of autostarts allowed can be set using the parameter "250.01 AutoStr" (in standby mode).

20.3 Master-Slave Handling

Each device detects the errors separately and saves them. The slaves transmit their errors to the master. The master collects these error messages and enters the slave errors as warnings into its history.

Example:

Slave 1 has detected overtemperature. It enters this error in its history and reports it to the master, which also enters it as a warning into its failure history ("Menu 420# Failure History").

The following message appears in the lower display line on the master.



```
F138 S1 Warning → ←
```

If warning 138 is still active on slave 1, the Enter symbol appears at the end.

After the warning has been confirmed on the master by pressing the <ENTER> key, it is forwarded to the respective slave.

The master shows the following message after confirmation.



```
F138 S1 Warning
```

i No comparison between master and slave

The error and event memory are not compared between the master and slaves. The errors of the slave device are acknowledged when the Sunny Island system is restarted.

20.4 Handling of Pending Errors during the Booting Procedure

During the booting procedure, all pending failures are generally confirmed without an entry being made in the history. This way, after the booting procedure, a failure that is still pending will be reentered, or if the system detects that this failure has disappeared, it is entered as no longer being present.

20.5 Display of Failures and Events

Each failure and each event have a unique three-digit display number that is created according to the parameter/measuring value assignment. The events and failures have the identical numerical range:

- 1xx - INV - Inverter
- 2xx - BAT - Battery
- 3xx - EXT - External
- 4xx - GEN - Generator
- 5xx - GRD - Grid
- 6xx - RLY - Relay
- 7xx - SYS - System
- 8xx - AUX - External devices and components

i Meaning of abbreviations

"F" indicates a failure, "W" a warning and "E" an event.

In the event of a failure, and provided it is recorded, "!" is displayed for a failure that has occurred and "C" is displayed for a failure that has stopped.

20.6 Events

The meanings of the events displayed by the Sunny Island are described in the following table:

20.6.1 Category INV

Display no.	Description
E101	Waiting mode
E102	Startup process
E103	Operation
E104	Operating on the generator (at external input)
E105	Operation on utility grid (at external input)
E106	Feeding-in grid operation (at external input)

Display no.	Description
E107	Sleep mode (slave in single-phase systems)
E108	Silent mode on utility grid
E110	Shutdown due to error
E115	Emergency charge
E118	Automatic start
E119	Manual start (transition from standby mode to operation)
E120	Manual stop (transition from operation to standby mode)
E121	Start of energy saving mode
E122	End of energy saving mode
E129	External start (remote)
E130	External stop (remote)
E131	Start of automatic frequency synchronization
E132	End of automatic frequency synchronization

20.6.2 Category BAT

Display no.	Description
E202	(Partial) reset of BMS due to new battery
E203	State change, battery charging algorithm for float charge
E204	State change, battery charging algorithm for boost charge
E205	State change, battery charging algorithm for full charge
E206	State change into silent mode option
E207	State change, battery charging algorithm for equalization charge
E221	Status change battery-preservation mode level 1
E222	Status change battery-preservation mode level 2
E223	Status change battery-preservation mode level 3

20.6.3 Category GEN

Display no.	Description
E401	Automatic generator start due to set criteria (battery state of charge, power, time, etc.)
E402	Automatic generator stop due to set criteria (battery state of charge, power, time, etc.)
E403	Manual generator start

Display no.	Description
E404	Manual generator stop
E405	Manual error acknowledgment of generator error
E406	Source of generator request
E407	Current-regulated generator operation initiated
E408	Current-controlled generator operation stopped

20.6.4 Category GRD

Display no.	Description
E501	Grid request due to SOC (insufficient value)
E502	Release of grid due to SOC (exceeds)
E503	Grid request due to exceeding the power limit
E504	Release of grid due to falling below the power limit
E505	Manual grid request
E506	Manual grid release
E507	Feed-in started
E508	Feed-in stopped

20.6.5 Category REL

Display no.	Description
E601	Relay 1 off
E602	Relay 1 on
E603	Relay 1 slave 1 off
E604	Relay 1 slave 1 on
E605	Relay 1 slave 2 off
E606	Relay 1 slave 2 on
E607	Relay 1 slave 3 off
E608	Relay 1 slave 3 on
E609	Transfer relay open
E610	Transfer relay closed
E611	Transfer relay on slave 1 open
E612	Transfer relay on slave 1 closed
E613	Transfer relay on slave 2 open

Display no.	Description
E614	Transfer relay on slave 2 closed
E615	Transfer relay on slave 3 open
E616	Transfer relay on slave 3 closed
E617	Relay 2 open
E618	Relay 2 closed
E619	Relay 2 slave 1 open
E620	Relay 2 slave 1 closed
E621	Relay 2 slave 2 open
E622	Relay 2 slave 2 closed
E623	Relay 2 slave 3 open
E624	Relay 2 slave 3 closed
E625	Digital input OFF (Low)
E626	Digital input ON (High)
E627	Digital input slave 1 to OFF (low)
E628	Digital input slave 1 to ON (high)
E629	Digital input slave 2 to OFF (low)
E630	Digital input slave 2 to ON (high)
E631	Digital input slave 3 to OFF (low)
E632	Digital input slave 3 to ON (high)

20.6.6 Category SYS

Display no.	Description
E705	Device start
E706	date, time changed
E707	New system configured in QCG
E708	Part 1 of firmware updated
E709	Part 2 of firmware updated
E710	Cluster firmware updated
E711	MMC/SD memory card inserted
E712	Parameters from MMC/SD memory card loaded
E851	Sunny Island Charger #1 detected
E852	Sunny Island Charger #2 detected

Display no.	Description
E853	Sunny Island Charger #3 detected
E854	Sunny Island Charger #4 detected
E901	SOC recalibration started
E902	SOC recalibration stopped
E903	Derating started
E904	Derating stopped
E905	Preventive self-disconnection to protect the battery from deep discharge

20.7 Failure Categories

The Sunny Island distinguishes between five different levels of errors, each requiring different user interaction:

Level	Designation	Display	Meaning
1	Warning	Warning	Warning, device continues to run. There is an explicit information on the Home Screen that a warning was recorded.
2	Malfunction 1	Malfunction	Failure that can only be detected during operation. Device switches off. Device can be restarted immediately (autostart).
3	Malfunction 2	Malfunction	Failure that can also be detected in standby mode. Device switches off. The device can only be restarted (autostart) once the system detects that the malfunction has ended.
4	Error	Failure	Device error, device switches off. User interaction required (troubleshooting, confirmation, manual restart)
5	Device defect	Defect	Device is defect. Device switches off and does not switch on again. Permanent operation inhibition. Device must be replaced.

20.8 Warnings and Error Messages

The meanings of the warnings and errors displayed by the Sunny Island are described in the following table:

20.8.1 Category INV

Display no.	Level	Description
F109	3	Transformer overtemperature
W110	1	Overtemperature transformer slave 1
W111	1	Overtemperature transformer slave 2
W112	1	Overtemperature transformer slave 3
F113	3	Overtemperature heat sink
W114	1	Overtemperature heat sink slave 1
W115	1	Overtemperature heat sink slave 2
W116	1	Overtemperature heat sink slave 3
F117	2	AC current limit (short-circuit control active for too long)
W118	1	AC current limitation (short-circuit control active for too long) slave 1
W119	1	AC current limitation (short-circuit control active for too long) slave 2
W120	1	AC current limitation (short-circuit control active for too long) slave 3
F121	3	Inverter overvoltage
W122	1	Inverter overvoltage slave 1
W123	1	Inverter overvoltage slave 2
W124	1	Inverter overvoltage slave 3
W137	1	Derating due to temperature (heat sink or transformer)
W138	1	Derating due to temperature (heat sink or transformer) slave 1
W139	1	Derating due to temperature (heat sink or transformer) slave 2
W140	1	Derating due to temperature (heat sink or transformer) slave 3
F141	2	Inverter undervoltage
W142	1	Inverter undervoltage slave 1
W143	1	Inverter undervoltage slave 2
W144	1	Inverter undervoltage slave 3
F158	2	Voltage on output AC1
W159	1	Voltage on output AC1 slave 1
W160	1	Voltage on output AC1 slave 2
W161	1	Voltage on output AC1 slave 3

20.8.2 Category BAT

Display no.	Level	Description
F201	2	Measuring range of battery voltage exceeded
W202	1	Measuring range of battery voltage exceeded on slave 1
W203	1	Measuring range of battery voltage exceeded on slave 2
W204	1	Measuring range of battery voltage exceeded on slave 3
F206	3	Battery overtemperature
F208	3	Battery overvoltage error
W209	1	Battery overvoltage error
W210	1	Battery overvoltage warning
W211	1	Low battery temperature warning
W212	1	High battery temperature warning
F213	2	Warning low battery voltage
W220	1	Warning SOH < 70%
F221	4	External battery management detected although no external energy management has been configured.

20.8.3 Category EXT

Display no.	Level	Description
W309	1	Relay protection
W310	1	Relay protection slave 1
W311	1	Relay protection slave 2
W312	1	Relay protection slave 3
F314	2	External voltage failure
W315	1	Disconnection from utility grid/generator due to insufficient external voltage
W316	1	Disconnection from utility grid/generator due to insufficient external voltage slave 1
W317	1	Disconnection from utility grid/generator due to insufficient external voltage slave 2
W318	1	Disconnection from utility grid/generator due to insufficient external voltage slave 3
W319	1	Disconnection from utility grid/generator due to excessive external voltage

Display no.	Level	Description
W320	1	Disconnection from utility grid/generator due to excessive external voltage slave 1
W321	1	Disconnection from utility grid/generator due to excessive external voltage slave 2
W322	1	Disconnection from utility grid/generator due to excessive external voltage slave 3
W323	1	Disconnection from utility grid/generator due to insufficient external frequency
W324	1	Disconnection from utility grid/generator due to insufficient external frequency slave 1
W325	1	Disconnection from utility grid/generator due to insufficient external frequency slave 2
W326	1	Disconnection from utility grid/generator due to insufficient external frequency slave 3
W327	1	Disconnection from utility grid/generator due to excessive external frequency
W328	1	Disconnection from utility grid/generator due to excessive external frequency slave 1
W329	1	Disconnection from utility grid/generator due to excessive external frequency slave 2
W330	1	Disconnection from utility grid/generator due to excessive external frequency slave 3
W331	1	Disconnection from utility grid/generator due to islanding
W332	1	Disconnection from utility grid/generator due to islanding (slave 1)
W333	1	Disconnection from utility grid/generator due to islanding (slave 2)
W334	1	Disconnection from utility grid/generator due to islanding (slave 3)
W335	1	Disconnection from utility grid/generator due to breach of voltage limits (redundant measurement)
W336	1	Disconnection from utility grid/generator due to breach of voltage limits of slave 1 (redundant measurement)
W337	1	Disconnection from utility grid/generator due to breach of voltage limits of slave 2 (redundant measurement)
W338	1	Disconnection from utility grid/generator due to breach of voltage limits of slave 3 (redundant measurement)
W339	1	Disconnection from utility grid/generator due to voltage increase protection

Display no.	Level	Description
W340	1	Disconnection from utility grid/generator due to voltage increase protection slave 1
W341	1	Disconnection from utility grid/generator due to voltage increase protection slave 2
W342	1	Disconnection from utility grid/generator due to voltage increase protection slave 3
W343	1	Disconnection from the external source, because the relation of the external voltage to the battery voltage is too high.
W344	1	Disconnection from the slave 1 external source, because the relation of the external voltage to the battery voltage is too high.
W345	1	Disconnection from the slave 2 external source, because the relation of the external voltage to the battery voltage is too high.
W346	1	Disconnection from the slave 3 external source, because the relation of the external voltage to the battery voltage is too high.
W347	1	Disconnection from external source due to excessive load
W348	1	Disconnection from external source due to excessive load slave 1
W349	1	Disconnection from external source due to excessive load slave 2
W350	1	Disconnection from external source due to excessive load slave 3
W351	1	Disconnection from external source due to external short circuit
W352	1	Disconnection from external source due to external short circuit slave 1
W353	1	Disconnection from external source due to external short circuit slave 2
W354	1	Disconnection from external source due to external short circuit slave 3
W377	1	Output current of the Sunny Island is greater than the nominal grid current/nominal generator current (master)
W378	1	Output current of the Sunny Island is greater than the nominal grid current/nominal generator current (slave 1)
W379	1	Output current of the Sunny Island is greater than the nominal grid current/nominal generator current (slave 2)
W380	1	Output current of the Sunny Island is greater than the nominal grid current/nominal generator current (slave 3)

20.8.4 Category GEN

Display no.	Level	Description
W401	1	Reverse power protection (generator)
W402	1	Generator management switches into the locked error status (Fail-Lock)

20.8.5 Category GRD

Display no.	Level	Description
W501	1	Grid reverse current prevented (quick grid disconnection)
W502	1	Grid reverse current prevented (quick grid disconnection) slave 1
W503	1	Grid reverse current prevented (quick grid disconnection) slave 2
W504	1	Grid reverse current prevented (quick grid disconnection) slave 3
W505	1	Feed-in current is greater than the nominal grid current (parameter "#232.03 GdCurNom")
W506	1	Feed-in current is greater than the nominal grid current (parameter "#232.03 GdCurNom") on slave 1
W507	1	Feed-in current is greater than the nominal grid current (parameter "#232.03 GdCurNom") on slave 2
W508	1	Feed-in current is greater than the nominal grid current (parameter "#232.03 GdCurNom") on slave 3

20.8.6 Category RLY

Display no.	Level	Description
F605	4	Transfer relay does not open
W606	1	Transfer relay does not open slave 1
W607	1	Transfer relay does not open slave 2
W608	1	Transfer relay does not open slave 3

20.8.7 Category SYS

Display no.	Level	Description
F702	5	DSP reset
F703	2	Timeout during a task
F704	4	Invalid DSP calibration
W705	1	Watchdog DSP has been tripped

Display no.	Level	Description
F706	4	Watchdog meter elapsed (watchdog tripped several times in succession)
W707	1	Watchdog meter on slave 1 elapsed (watchdog tripped several times in succession)
W708	1	Watchdog meter on slave 2 elapsed (watchdog tripped several times in succession)
W709	1	Watchdog meter on slave 3 elapsed (watchdog tripped several times in succession)
F710	4	Autostart meter elapsed (several autostarts in succession)
W713	1	Watchdog has been tripped
F716	2	Measuring range of battery voltage exceeded
W717	1	Measuring range of battery voltage exceeded on slave 1
W718	1	Measuring range of battery voltage exceeded on slave 2
W719	1	Measuring range of battery voltage exceeded on slave 3
F720	4	Short circuit or cable break on transformer temperature sensor
F721	4	Short circuit or cable break on heat sink temperature sensor
W722	1	Short circuit on battery temperature sensor
W723	1	Cable break on battery temperature sensor
W724	1	Autostart meter slave 1 elapsed
W725	1	Autostart meter slave 2 elapsed
W726	1	Autostart meter slave 3 elapsed
F731	4	Error in cluster configuration
F732	4	Error in address assignment of cluster devices
F733	4	No message from cluster master (only slave)
W734	1	No message from cluster slave 1
W735	1	No message from cluster slave 2
W736	1	No message from cluster slave 3
W738	1	Synchronization not successful
F739	3	Internal communication of the master is interrupted
W740	1	Internal device communication of slave 1 interrupted
W741	1	Internal device communication of slave 2 interrupted
W742	1	Internal device communication of slave 3 interrupted
F743	3	Internal CAN communication of the master is interrupted

Display no.	Level	Description
W744	1	Internal CAN communication of slave 1 is interrupted
W745	1	Internal CAN communication of slave 2 is interrupted
W746	1	Internal CAN communication of slave 3 is interrupted
W747	1	Short circuit or cable break on transformer temperature sensor slave 1
W748	1	Short circuit or cable break on transformer temperature sensor slave 2
W749	1	Short circuit or cable break on transformer temperature sensor slave 3
W750	1	Short circuit or cable break on heat sink temperature sensor slave 1
W751	1	Short circuit or cable break on heat sink temperature sensor slave 2
W752	1	Short circuit or cable break on heat sink temperature sensor slave 3
W753	1	Invalid system time
F754	2	Communication with Multicluster Box interrupted
W755	1	Battery-preservation mode 1 (LBM)
W756	1	Battery-preservation mode 2 (LBM)
W757	1	Battery-preservation mode 3 (LBM)
F758	2	No output voltage measured from the main cluster
W759	1	No output voltage measured from slave 1 of main cluster
W760	1	No output voltage measured from slave 2 of main cluster
W761	1	No output voltage measured from slave 3 of main cluster
F781	4	Error at a slave which leads to shutdown of the system (for the "RunMod" function)
F782	4	Failure of the grid monitoring
F783	2	Slave does not receive a Syncpuls
W784	1	Slave does not receive a Syncpuls Slave 1
W785	1	Slave does not receive a Syncpuls Slave 2
W786	1	Slave does not receive a Syncpuls Slave 3
W791	1	DSP reset detected on slave 1
W792	1	DSP reset detected on slave 2
W793	1	DSP reset detected on slave 3
W797	1	Failure of the grid monitoring slave 1
W798	1	Failure of the grid monitoring slave 2
W799	1	Failure of the grid monitoring slave 3

20.8.8 AUX Category

Display no.	Level	Description
F801	4	Plausibility check of contactors in a Multicluster Box failed
W804	1	Grid operation not possible
W805	1	Generator operation not possible
F806	4	Multicluster Box settings do not match software settings.
W807	1	No valid line voltage for requested grid operation
W808	1	Error Q4 contactor
F809	4	Error Q10 contactor (load shedding)
F810	4	Error in 15 V supply of the Multicluster Box
F811	4	Error in 24 V supply of the Multicluster Box
W815	1	Error Q5 contactor
F816	2	Error Q7 contactor
F817	4	Error Q9 contactor
F818	4	A phase is missing, Multicluster Box goes into "Failure" status
W824	1	Error Q4 contactor
W851	1	Battery reversely connected or short circuit on Sunny Island Charger 1
W852	1	Battery overvoltage Sunny Island Charger 1
W853	1	Overvoltage PV array Sunny Island Charger 1
W854	1	No PV voltage or short circuit on Sunny Island Charger 1
W855	1	Sensor error (or undertemperature) on Sunny Island Charger 1
W856	1	Overtemperature Sunny Island Charger 1
W857	1	No communication with Sunny Island Charger 1 for more than 24 h
W861	1	Battery reversely connected or short circuit on Sunny Island Charger 2
W862	1	Battery overvoltage Sunny Island Charger 2
W863	1	Overvoltage PV array Sunny Island Charger 2
W864	1	No PV voltage or short circuit on Sunny Island Charger 2
W865	1	Sensor error (or undertemperature) on Sunny Island Charger 2
W866	1	Overtemperature Sunny Island Charger 2
W867	1	No communication with Sunny Island Charger 2 for more than 24 h
W871	1	Battery reversely connected or short circuit on Sunny Island Charger 3
W872	1	Battery overvoltage Sunny Island Charger 3
W873	1	Overvoltage PV array Sunny Island Charger 3

Display no.	Level	Description
W874	1	No PV voltage or short circuit on Sunny Island Charger 3
W875	1	Sensor error (or undertemperature) on Sunny Island Charger 3
W876	1	Overtemperature Sunny Island Charger 3
W877	1	No communication with Sunny Island Charger 3 for more than 24 h
W881	1	Battery reversely connected or short circuit on Sunny Island Charger 4
W882	1	Battery overvoltage Sunny Island Charger 4
W883	1	Overvoltage PV array Sunny Island Charger 4
W884	1	No PV voltage or short circuit on Sunny Island Charger 4
W885	1	Sensor error (or undertemperature) on Sunny Island Charger 4
W886	1	Overtemperature Sunny Island Charger 4
W887	1	No communication with Sunny Island Charger 4 for more than 24 h
F890	2	Interference at external measurement point of Multicluster Box
F891	2	Interference at external measurement point of Multicluster Box slave 1
F892	2	Interference at external measurement point of Multicluster Box slave 2
F893	2	Interference at external measurement point of Multicluster Box slave 3

20.8.9 Category SYS

Display no.	Level	Description
W915	1	DSP failure
F920	3	Error message via SiCom: General
F921	3	Error message via SiCom: Battery overvoltage
F922	3	Error message via SiCom: Battery undervoltage
F923	3	Error message via SiCom: Battery overtemperature
F924	3	Error message via SiCom: Battery undertemperature
F925	3	Error message via SiCom: Battery overtemperature in charge mode
F926	3	Error message via SiCom: battery undertemperature in charge mode
F927	3	Error message via SiCom: battery charging current too high
F928	3	Error message via SiCom: Battery charging current in charge mode too high
F929	3	Error message via SiCom: Error in the battery
F930	3	Error message via SiCom: Short circuit
F931	3	Error message via SiCom: Internal error in battery management

Display no.	Level	Description
F932	3	Error message via SiCom: Different state of charge of the battery cells
F935	3	Error message via SiCom: Error in the generator
W936	1	Warning via SiCom: General
W937	1	Warning via SiCom: Battery overvoltage
W938	1	Warning via SiCom: Battery undervoltage
W939	1	Warning via SiCom: Battery overtemperature
W940	1	Warning via SiCom: Battery undertemperature
W941	1	Warning via SiCom: Battery overtemperature in charge mode
W942	1	Warning via SiCom: Battery undertemperature in charge mode
W943	1	Warning via SiCom: battery charging current too high
W944	1	Warning via SiCom: battery charging current in charge mode too high
W945	1	Warning via SiCom: error in the battery
W946	1	Warning via SiCom: short circuit
W947	1	Warning via SiCom: internal error in battery management
W948	1	Warning via SiCom: different state of charge of the battery cells
W951	1	Warning via SiCom: Generator
F952	3	Time for external battery management exceeded
W953	1	Time for external battery management exceeded

20.9 Troubleshooting

Answers are provided below for faults that may occur in practice:

Why does the Sunny Island not connect to the running generator?

- Is the AC disconnection unit on the generator ok?
- Has the power which is allowed to be fed back into the generator during the permissible time been exceeded (parameter "233.14 GnRvTm")? If yes, "!" is displayed. Generator connection is blocked for the set time. Set the parameter "540.02 GnAck" to Ackn.
- If the generator control relay (GnReq) is open has the generator been started manually (parameter "234.07 GnStrMod")? Change the setting to autostart, if required.
- Is a GenMan used in the system?
 - Check the return signal (DigIn)
 - The generator can only be started manually using GenMan.

Why is the display of the Sunny Island dark and why is nothing shown on the display?

- Is the DC circuit breaker of the Sunny Island switched to "ON"? In this case, the device has switched off to protect the battery from deep discharge (see Section 13.4 "State of Charge (SOC) and State of Health (SOH)", page 109). After self-disconnection, restart the Sunny Island as described in this document (see Section 9.5 "Recommissioning After Automatic Shutdown", page 77).
- The external battery fuse has tripped.

Why is it not possible to change the parameters?

- Has the installer password been entered correctly? Check whether you are in "Installer Level" (see Section 10.5 "Entering the Installer Password", page 88). If necessary, repeat the calculation and entry of the password.
- You are in the "100-Meters" (measuring data) main menu or in the "300-Diagnosis" (diagnosis) menu, for example. You can only read the data values shown here.
- Some parameters can only be changed in standby mode or in the QCG, e.g. the parameter "234.07 GnStrMod" (see Section 19.2 "Adjustable Parameters", page 167). Stop the Sunny Island (see Section 9.2 "Stopping the Sunny Island (Standby)", page 76). Note that this causes a failure of the stand-alone grid and the loads are no longer supplied.

Why does the Sunny Island connect to the running generator only for a short time?

- The limits for the maximum permissible AC voltage or the minimum permissible frequency of the generator are too strict (parameter in the menu "233# Generator Control"). Change the voltage and/or frequency thresholds while observing the technical data of your generator.

Why does the "VAC-Low" error (output voltage too low) also occur when the Sunny Island is started?

- A permanent short-circuit exists in the stand-alone grid. Check the AC output connections of the stand-alone grid (see Section 6.3 "AC Connection", page 48).
- The consumption of the loads connected to the stand-alone grid is too high. The power/ electrical energy of the Sunny Island is not sufficient to supply the loads. Switch off some of the loads and restart the Sunny Island.

Why is the frequency of the stand-alone grid not at 60 Hz?

- The Sunny Boy inverter is controlled via the frequency (see Section 17.5 "Frequency-Shift Power Control (FSPC)", page 154).
- The automatic frequency synchronization function of the Sunny Island 4548-US / 6048-US is activated (see Section 12.7 "Automatic Frequency Synchronization", page 106).
- Power fluctuations cause frequency deviations.

What can I do when the battery cell of a lead-acid battery can no longer be used?

- Remove the cell that can no longer be used from your battery bank. Start the Sunny Island and change the battery voltage in the QCG under "New Battery".

What can I do when the QCG does not run?

- Switch off the Sunny Island (see Section 9.3 "Switching Off", page 76) and restart it (see Section 9.1 "Switching On", page 75).

What can I do when "MMC operation failed" appears on the display?

- You wanted to perform an action using the SD memory card, but it failed (see Section 10.9 "Display of Warnings and Failures", page 93). Check the card (on your PC/laptop). If necessary, use a new SD memory card.

Why does my Sunny Island stay on even though I switched the DC circuit breaker to "Off"?

- Your Sunny Island may be powered by the AC side. Switch off all AC loads and disconnect them from the Sunny Island (see Section 9.4 "Disconnecting the Device from Voltage Sources", page 76).

Why is my battery discharging even though the generator is running?

- The power produced by the generator does not reach the Sunny Island. Check the voltage and frequency values. The fuses on the generator may have been tripped.
- The load power exceeds the generator power "234.03 GnCurNom".
 - Check the error messages. Find the cause.

Why is the deactivation defined by the SOC in case of a full or equalization charge and generator start in the second time zone?

- The equalization charge has a higher priority than silent time.

Why is the SOC not 100% after completion of full charge?

- Set a longer absorption period.

How is it possible to ensure that the maximum battery charging current is correctly calculated after a reinstallation of the battery current sensor?

- Recalibrate the battery current sensor using the parameter "225.04 BatCurAutoCal" with the setting "Start".

What is required if the Sunny Island is continuously switched off after Low Battery Mode (LBM) when restarting the device?

- Start the generator manually, if required (e.g.: Run 1 h). Consider the warm-up times: five minutes without charging current in BatProtMode can cause the device to change to standby mode.

How is it possible to change between wintertime and summertime operation e.g. for alpine huts?

- Save two different parameter sets on the SD memory card and activate them via parameter "550.02 ParaLod" (see Section 11.3 "Saving and Loading Parameters", page 98).

What happens if the card inserted is not FAT16 formatted?

- The Sunny Island displays the message "Incomp".

Why does the generator and/or the utility grid not reconnect although the (voltage or frequency) limit for disconnection has been exceeded again?

- The Sunny Island connects with a so-called hysteresis, i.e., the connection value is slightly below or above the disconnection value. These thresholds are preset by default.

Why is it not possible to set any combinations of voltage and frequency limits?

- The possible ranges for voltage and frequency of the Sunny Island allow the combination of special frequencies and voltages that result in transformer saturation and are therefore not permitted.

Why is it that one (or more) extension clusters remain in standby, although the main cluster is operating properly?

- Is the data cable between the master devices connected? The main master cannot forward the "Start" command to the extension master. The devices remain in standby.

Why is the Multicluster system not supplying full power?

- Has an extension cluster's slave failed? The system continues to operate, but with correspondingly lower output on the line conductor of the failed device.

Why is it that shortly after startup, the slave switches to standby with the error message F117, but the master continues to operate?

- Are the line conductors within the cluster or from the cluster to the Multicluster Box connected the wrong way around? This causes a permanent short-circuit in the cluster, and the slave reports this to the master.

What is the meaning of the F605 error message?

- The F605 error message might occur, among other things, if you have installed a direct connection with switch between the AC input (AC2) and the AC output (AC1) of the Sunny Island. If such a connection is not installed on the Sunny Island and if the switch is closed, the Sunny Island is surpassed. If the Sunny Island did not give the order for closing its internal transfer relay itself, it displays the F605 error message and does not start operation. Open the bypass switch and restart the Sunny Island afterwards to fix this error.

Why is it that high outputs are being transferred back and forth between the clusters in the cluster network?

- The nominal frequencies and voltages are defined differently. Correct this by means of the appropriate parameters.

What is the meaning of the F221 error message?

- Error message F221 appears when a battery with external battery management has been connected to the Sunny Island (e.g. a lithium-ion battery), the Sunny Island, however, is not set to this battery type. Start the QCG and change the system configuration on the connected battery type (see Section 8.2 "Starting the Quick Configuration Guide (QCG)", page 69).

20.10 Procedure during Emergency Charge Mode

The Sunny Island cannot provide voltage with full amplitude with a deeply discharged battery and can no longer synchronize with an existing grid or generator. Using the emergency charge mode (ECM), it is possible to charge the batteries in current-controlled mode.

Emergency charge mode with lead-acid batteries only

In emergency charge mode, a lead-acid battery must be connected to the Sunny Island. Emergency charge mode is not possible with lithium-ion batteries.

To charge the batteries in the emergency charge mode, either bridge the AC1 with AC2 (for a stationary generator) or connect a portable generator directly to AC1.

All loads must be disconnected in emergency charge mode.

Battery Management

The battery management is active and the current set battery parameters and the current charging phase are used. These values can be changed in "normal operation".

Generator and Grid Management

In emergency charge mode, the generator management and grid management are **not** active. Reverse power protection and relay protection are also not active.

AC1 and AC2 are bridged

If AC1 and AC2 have been bridged, the generator should first be connected and then started/started by hand. Otherwise, it is possible that the magnetizing current trips the generator fuse. (This can also happen when connecting the relay without using a bridge.)

Emergency charge mode is activated in the QCG. Follow the instructions on starting the QCG up to point 2 (see Section 8.2 "Starting the Quick Configuration Guide (QCG)", page 69). Then start the emergency charge mode as described in the following

1. Select "Emerg Charge" in QCG with <ENTER>.

```
01#StartMenu
Emerg. Charge
```

- 2. Confirm the following view with <ENTER>.



- 3. Set the maximum external current, e.g. that of the generator.



- 4. Confirm the set value with <ENTER>.

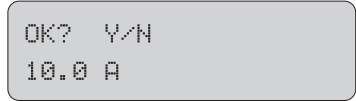

- 5. Use the down arrow key.
 - The display on the right appears.

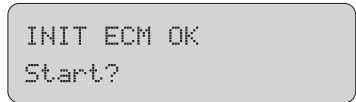

- 6. Press <ENTER> to confirm.

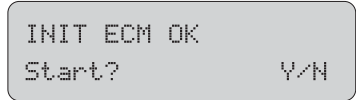

- 7. Press <ENTER>.

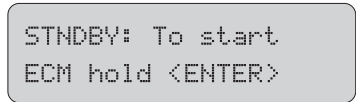

- The emergency charge mode is started.

Interrupt the emergency charge mode, e.g. in order to refill diesel:

- 1. Press <ENTER> to stop the Sunny Island.
 - The notification shown here is displayed.



- 2. Press and hold <ENTER>.
 - The remaining time is displayed as a bar.



- The emergency charging mode is interrupted. The notification shown here is displayed.

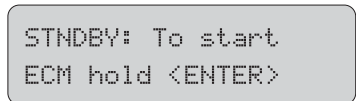

i Prematurely ending the Emergency Charge Mode

In order to exit the emergency charge mode early, the Sunny Island must be restarted with parameter "510.01 InvRs".

In emergency charge mode, process values are shown in the display. Parameters cannot be changed during the charging process. If the Sunny Island is restarted, the settings that were saved before the ECM are loaded.



Bridge between AC1 and AC2

After emergency charge mode has been completed make sure to remove the bridge between AC1 and AC2!



Restarting

Observe information for restarting and wait for 15 minutes (see Section 9.5 "Recommissioning After Automatic Shutdown", page 77).

21 Accessory

The following overview details the accessories and spare parts for your product. If necessary, you can order these from SMA Solar Technology or your distributor.

Designation	Brief description	SMA order number
BatFuse-B.01 (250 A) (not UL certified)	2-pole LV/HRC battery fuse-switch-disconnector, size 1 for 1 Sunny Island, 3 DC inputs (1 x battery and 2 x Sunny Island Charger 50), 1 x auxiliary voltage output with 8 A	BATFUSE-B.01
BatFuse-B.03 (250 A) (not UL certified)	Two-pole LV/HRC battery fuse-switch-disconnector, size 1 for up to three Sunny Island, 6 DC inputs (2 x battery and 4 x Sunny Island Charger 50), 1 x auxiliary voltage output with 8 A	BATFUSE-B.03
Load-shedding contactor	Three-pole load-shedding contactor with 48 V DC coil for Sunny Island The load-shedding contactor is available in several versions. You can obtain more information from SMA or your specialty retailer.	SI-LSXX
SI-Shunt	Measuring shunts for the battery current detection The measuring shunt is available in several versions. You can obtain more information from SMA.	SI-SHUNTXXX
Sunny Island Charger (not UL-certified)	Solar charge controller for Sunny Island systems Battery voltage: 48 V/24 V/12 V Battery current: 50 A at 48 V, 50 A at 12 V/24 V Nominal power: 2,000 W at 48 V, max. PV voltage: 140 V Must not be used with lithium-ion batteries .	SIC50-MPT
Smart Load 6000	Adjustable dump load	SL6000
RS485 retrofit kit	RS485 interface	485PB-G3
Multicluster Piggy-Back	Interface for communication between the Sunny Island and the Multicluster Box	MC-PB
Sunny Island Charger Piggy-Back	Interface for communication between the Sunny Island and Sunny Island Charger	SIC-PB

22 Technical Data

22.1 Sunny Island 4548-US

Output Data		SI 4548-US-10
Nominal AC voltage (adjustable)	$V_{AC, nom}$	120 V (105 V to 132 V)
Nominal frequency	f_{nom}	60 Hz (55 to 65 Hz)
Continuous AC power at 77°F (25°C)	P_{nom}	4,500 W
AC power for 30 minutes at 77°F (25°C)	P_{30min}	5,300 W
AC power for 1 minute at 77°F (25°C)	P_{1min}	8,400 W
AC power for 3 seconds at 77°F (25°C)	P_{3sec}	11,000 W
Continuous AC power at 104°F (40°C)	P_{nom}	3,100 W
AC power at 104°F (40°C) for 3 hours	P_{3h}	4,000 W
Continuous AC power at 122°F (50°C)	P_{nom}	1,800 W
Continuous AC power at 140°F (60°C)	P_{nom}	200 W
Nominal AC current	$I_{AC, nom}$	37.5 A
Maximum current (peak value) for 60 ms	$I_{AC, max}$	180 A
Total harmonic factor of the output voltage	K_{VAC}	< 3%
Power factor $\cos \varphi$		-1 to +1
Input Data		
Input voltage (adjustable)	$V_{AC, ext}$	120 V (80 V to 150 V)
Input frequency (adjustable)	f_{ext}	60 Hz (54 Hz to 66 Hz)
Maximum AC input current (adjustable)	$I_{AC, ext}$	56 A (0 A to 56 A)
Maximum input power	$P_{AC, ext}$	6.7 kW
Battery Data		
Battery voltage (range)	$V_{Bat, nom}$	48 V (41 V to 63 V)
Maximum battery charging current	$I_{Bat, max}$	110 A
Continuous charging current	$I_{Bat, nom}$	85 A
Battery type		Lead-acid battery: VRLA/FLA NiCd battery Lithium-ion battery
Battery capacity for lead-acid batteries and NiCd batteries	C_{Bat}	100 Ah to 10,000 Ah

Battery Data

Battery capacity for lithium-ion batteries	C_{Bat}	50 Ah to 10,000 Ah
Charge control		IUoU procedure with automatic full and equalization charge

Efficiency/power consumption **SI 4548-US-10**

Maximum efficiency		96%
Efficiency > 90%		5% P_{nom} to 120% P_{nom}
CEC weighted efficiency		94.5%

Efficiency curve

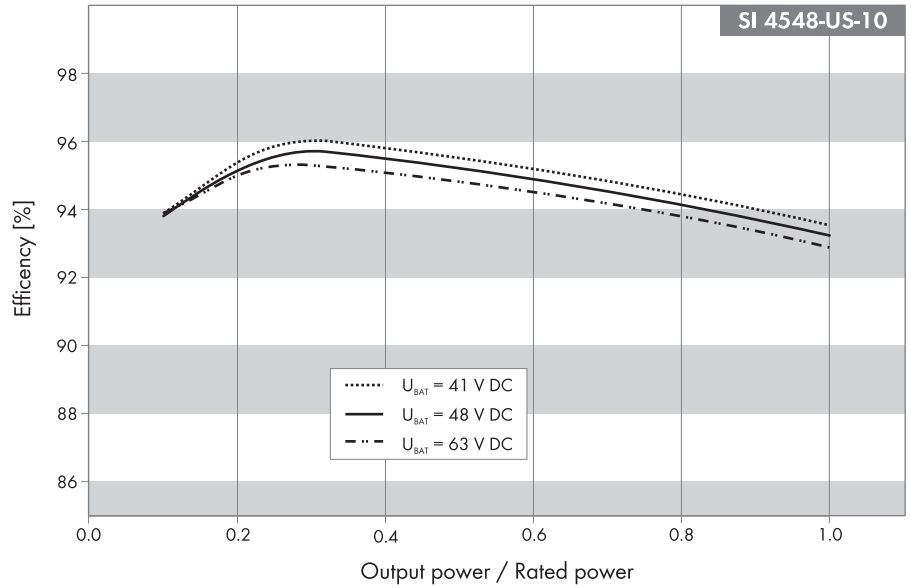

Self-consumption with no load (in standby mode)	25 W (4 W)
---	------------

General Data

Dimensions (W x H x D)	18.39 in x 24.10 in x 9.25 in (467 mm x 612 mm x 235 mm)
Weight	approx. 139 lb (approx. 63 kg)
Certification	UL 1741/UL1998
Degree of protection	NEMA 1
Device protection	Short-circuit, overload, overtemperature

General Data	
Ambient temperature	- 13°F to +140°F (- 25°C to +60°C)
Interfaces	SI 4548-US-10
Number of LEDs	2
Number of buttons	4
Display	Two-line display
Multifunction relay	2
Communication	RS485, galvanically insulated (optional)
Memory card	SD memory card
Digital input level (Dig-In)	High level as of 5 V (up to 63 V), low level 0 V to 2 V
Load switching limits multifunction relays 1 and 2	AC: 6 A at 250 V DC: see graphic

Load limitation curve

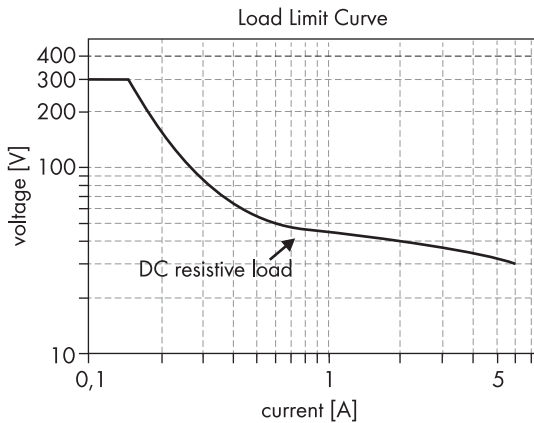

22.2 Sunny Island 6048-US

Output Data		SI 6048-US-10
Nominal AC voltage (adjustable)	$V_{AC, nom}$	120 V (105 V to 132 V)
Nominal frequency	f_{nom}	60 Hz (55 to 65 Hz)
Continuous AC power at 77°F (25°C)	P_{nom}	5,750 W
AC power for 30 minutes at 77°F (25°C)	P_{30min}	7,000 W
AC power for 1 minute at 77°F (25°C)	P_{1min}	8,400 W
AC power for 3 seconds at 77°F (25°C)	P_{3sec}	11,000 W
Continuous AC power at 104°F (40°C)	P_{nom}	4,700 W
AC power at 104°F (40°C) for 3 hours	P_{3h}	5,000 W
Continuous AC power at 122°F (50°C)	P_{nom}	3,500 W
Continuous AC power at 140°F (60°C)	P_{nom}	2,200 W
Nominal AC current	$I_{AC, nom}$	48.0 A
Maximum current (peak value) for 60 ms	$I_{AC, max}$	180 A
Total harmonic factor of the output voltage	K_{VAC}	< 3%
Power factor $\cos \varphi$		-1 to +1
Input Data		
Input voltage (adjustable)	$V_{AC, ext}$	120 V (80 V to 150 V)
Input frequency (adjustable)	f_{ext}	60 Hz (54 Hz to 66 Hz)
Maximum AC input current (adjustable)	$I_{AC, ext}$	56 A (0 A to 56 A)
Maximum input power	$P_{AC, ext}$	6.7 kW
Battery Data		
Battery voltage (range)	$V_{Bat, nom}$	48 V (41 V to 63 V)
Maximum battery charging current	$I_{Bat, max}$	140 A
Continuous charging current	$I_{Bat, nom}$	110 A
Battery type		Lead-acid battery: VRLA/FLA/ NiCd battery Lithium-ion battery
Battery capacity for lead-acid batteries and NiCd batteries	C_{Bat}	100 Ah to 10,000 Ah
Battery capacity for lithium-ion batteries	C_{Bat}	50 Ah to 10,000 Ah

Battery Data

Charge control	IUoU procedure with automatic full and equalization charge
----------------	--

Efficiency/power consumption **SI 6048-US-10**

Maximum efficiency	96%
Efficiency > 90%	5 to 120% P _{nom}
CEC weighted efficiency	94.0%

Efficiency curve

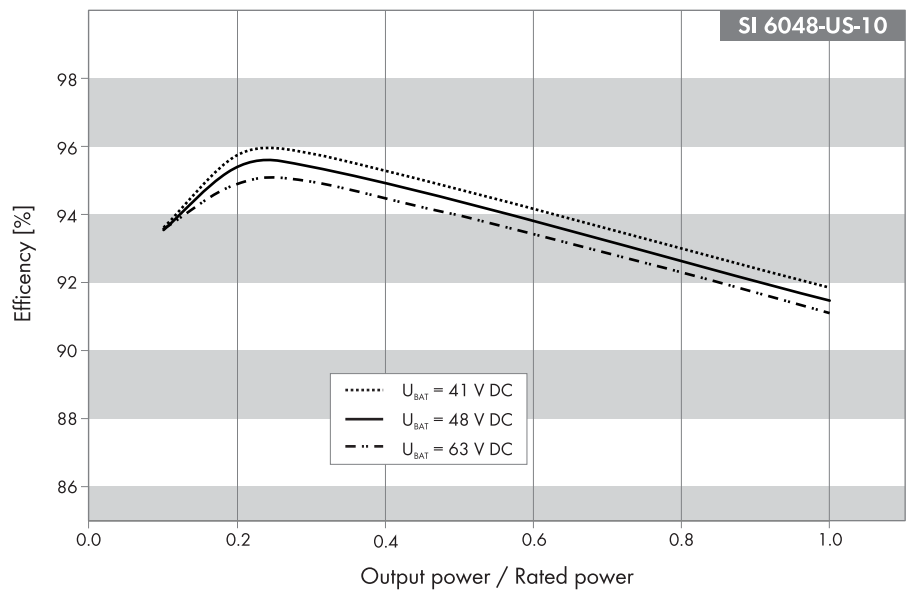

Self-consumption with no load (in standby mode)	25 W (< 4 W)
---	--------------

General Data

Dimensions (W x H x D in mm)	18.39 in x 24.10 in x 9.25 in (467 mm x 612 mm x 235 mm)
Weight	approx. 139 lb (approx. 63 kg)
Certification	UL 1741/UL1998
Degree of protection	NEMA 1

General Data	
Device protection	Short-circuit, overload, overtemperature
Ambient temperature	- 13°F to +140°F (- 25°C to +60°C)
Interfaces	
SI 6048-US-10	
Number of LEDs	2
Number of buttons	4
Display	Two-line display
Multifunction relay	2
Communication	RS485, galvanically insulated (optional)
Memory card	SD memory card
Digital input level (Dig-In)	High level as of 5 V (up to 63 V), low level 0 V to 2 V
Load switching limits multifunction relays 1 and 2	AC: 6 A at 250 V DC: see graphic

Load limitation curve

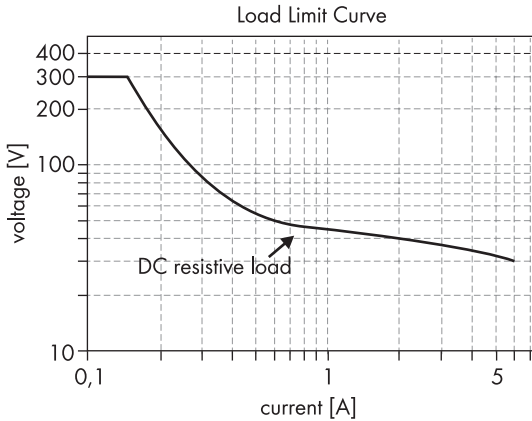

23 Glossary

Absorption Phase

Constant voltage phase: A charging phase using constant charging voltage. The charging current constantly decreases in this phase.

AC

Abbreviation for "Alternating Current"

AC Coupling

The AC side connection between loads, generators and storage devices.

AGM Battery

Absorbent Glass Mat separator battery. This is a battery where the electrolyte (a mixture of water and sulfuric acid) is bound to a glass fiber mat. This is a type of a sealed or valve regulated lead-acid (VRLA) lead-acid battery. A gas mixture (hydrogen and oxygen) is always generated when lead-acid batteries are charged, and in normal operation this internally recombines to form water. This removes the need for regularly refilling the battery cells with water, which is why these batteries are often described as "low maintenance" or even "maintenance free". AGM batteries are available from many different manufacturers for a wide range of applications. They usually have very good high current properties but are not very charge-cycle resistant in relation to deep discharge.

Ah

Abbreviation for "ampere-hour". Unit of electrical charge, one ampere-hour is the charge provided by a constant current of 1 A over a period of one hour.

AI

Abbreviation for anti-islanding. Procedure which prevents unintentional islanding on the utility grid.

Equalization Charge

Equalization charge: allows different series-connected battery cells to be charged to a unified state of charge of 95% to 100%. Without regular equalization charge, the state of charge of the different cells slowly drift apart, which can lead to a poor battery power performance and a premature battery storage system failure.

Battery-Backup System

Backup-backup systems are power supply systems that provide an extra level of security for standard power supply systems. The utility grid is usually the standard power supply system and the battery-backup system which is protected by an additional stand-alone grid system in the case of a power outage. In addition to the battery-backup systems, diesel generators in PV battery systems are also described as backup generators. They perform the same task as a battery-backup system for the utility grid.

Battery

A battery is an electrochemical energy storage that can release previously stored chemical energy as electrical energy. A distinction is made between non-rechargeable batteries (often used in end-customer markets) and rechargeable batteries (batteries). In stand-alone grid systems, lead-acid batteries are almost always used and, very rarely, nickel-cadmium batteries are used as secondary rechargeable batteries.

Battery Charge Mode

Operating mode of the battery inverter in which the inverter takes energy from the AC grid to recharge the battery in a controlled way. In this operating mode, the battery inverter is responsible for correctly charging the batteries and acts like an independent battery charger.

Battery Inverter

See Battery power converter

Battery Management

The battery management is responsible for optimum battery storage system charging and reliable protection against deep discharge. This is the only way of ensuring that the battery service life reflects the manufacturer's specifications.

Battery Power Converter

A bidirectional converter that can regulate voltage and frequency in a stand-alone grid as well as correctly charge the batteries.

Battery Storage System

The combination of serial and possibly also parallel connection of several identical batteries. Typical battery storage systems are 12 V, 24 V, 48 V and 60 V.

CEC

Abbreviation for "California Energy Commission"

Charge Mode

See Battery charging mode

C rate

The nominal capacity specification is always provided with the discharge time on which the capacity is based. The nominal capacity is the product of the constant charging current I_N and the discharge time t_N , which passes between commencement of discharging the fully charged battery and when the final cut-off voltage V_S is reached. For stationary batteries, the C10 capacity is usually specified, i. e. a battery with $C_{10} = 200$ Ah can be discharged for 10 hours at a nominal current of $0.1 \times C_{10} = 10 = 20$ A.

DC

Abbreviation for "Direct Current"

Derating

A controlled reduction in performance, usually dependent on component temperatures.

Derating is initiated in order to avoid the shutting down of the complete plant.

DSP

Abbreviation for Digital Signal Processor. A DSP is a microprocessor chip especially developed for digital signal processing and control.

Electrolyte

A chemical solution that allows the conduction of ions within a battery. In lead-acid batteries, the electrolyte is diluted sulfuric acid and is also a reactant in the electrochemical reaction. Nickel/cadmium batteries use an alkaline electrolyte (potassium hydroxide).

EPROM

See Flash EEPROM

Firmware

Firmware is software that is stored in a chip in various electronic devices, such as Sunny Island, hard disk recorders, DVD burners and players, newer television sets, household appliances and computers – in contrast to software that is stored on a hard drive, CD-ROM or other media. These days, firmware is usually stored in Flash memory or an EEPROM chip.

FLA

Flooded lead-acid battery: a lead-acid battery with liquid electrolyte, also often described as a flooded lead-acid battery.

Flash EEPROM

The abbreviation EEPROM stands for Electrically Erasable Programmable Read-Only Memory. Flash memory is a digital storage chip, the exact designation is Flash EEPROM. In contrast to "normal" EEPROM storage, individual bytes (the smallest addressable storage units) cannot be deleted. EEPROM is a non-volatile, electronic storage component that is used in the Sunny Island, the computer industry (among others) and usually in Embedded Systems. Flash EEPROMs are used where information must be permanently stored in the smallest amount of space, e.g. for storing the firmware.

MSD

See Automatic disconnection unit

Float Charge

Maintenance charge: Allows the batteries to be slowly charged to a state of charge of 100% without the negative effects of overcharging. Complete charging to 100% using float charge takes several days. For this reason, float charge is more important for battery-backup systems and less important for stand-alone grids.

Sealed Lead-Acid Battery

A type of battery in which the electrolyte (a mixture of water and sulfuric acid) is bound into a gel. This is a type of a sealed or valve regulated lead-acid (VRLA) lead-acid battery. A gas mixture (hydrogen and oxygen) is always generated when lead-acid batteries are charged, and in normal operation this internally recombines to form water. This removes the need for regularly refilling the battery cells with water, which is why these batteries are often described as "low maintenance" or even "maintenance free" (see also AGM batteries). Gel batteries are available from many different manufacturers for a wide range of applications. There are gel batteries for high current applications but also for cycle operation with very high deep discharge cycle resistance.

Protected Loads Panel

See "Stand-alone grid system".

I-Loop

I-loop enables generators with inadequate voltage regulation to be used in the Sunny Island system.

Stand-Alone Grid System

An energy generation system that supplies electrical energy completely independently of any external electrical energy supply.

Constant Current Phase

I-Phase: The charging phase in which charging can be done using the maximum allowable charging current.

Capacity

Describes the storage capability of a cell or battery, specified in Ah (ampere-hour).

The capacity of a battery is heavily dependent on the charging cycle, the amount of electrical current strength drawn and the temperature.

State of Charge

Describes the current amount of charge that can be drawn from the battery, in percent of the nominal capacity (100% = battery full, 0% = battery empty).

Maximum Power Point "MPP"

The operating point (current/voltage characteristic curve) of a PV array where the maximum power can be drawn. The actual MPP changes constantly depending e.g. on the level of solar irradiation and the temperature.

MPP Tracker

Regulation of the power drawn so that a PV field remains as close as possible to the MPP. This operating point varies with the solar irradiation and the temperature conditions of the modules. MPP tracking optimizes the extraction of electrical power and is a feature of inverters and charge controllers.

Multi-String Inverter

An inverter that combines the advantages of several string inverters (separate MPP tracking of individual strings) and a central inverter (lower performance specific costs).

Nominal Energy Throughput of the Battery

A nominal energy throughput is the calculated result of one full charge and discharge of the battery.

Grid-Tie Plant

A PV system that is connected to the utility grid, such as the power company.

NiCd

Nickel cadmium battery, contains nickel, cadmium and potassium hydroxide as electrolytes. They require a significantly higher charging voltage, have a lower level of efficiency and are significantly more expensive than lead-acid batteries. Their robustness, cycle resistance and low temperature capabilities allow them to be used in certain special applications.

Parallel Connection

Parallel connection of the batteries (all positive terminals connected and all negative terminals connected) increases the capacity of the battery storage system while keeping the voltage constant.

Example: Two 24 V/100 Ah batteries connected in parallel still have a voltage of 24 V, however, a capacity of $100 \text{ Ah} + 100 \text{ Ah} = 200 \text{ Ah}$.

Piggy-Back (Printed Circuit Board)

A printed circuit board that is plugged into another assembly to increase performance. A Piggy-Back can also replace an individual chip. In this case, the chip is removed and the Piggy-Back is plugged into the empty base.

Photovoltaics

Photovoltaics (PV) is the conversion of solar irradiation into electrical energy using special semiconductors called PV cells.

PV System

Describes the totality of devices required for the exploitation and utilization of solar energy. In grid-tie systems, this includes not only the PV array, but also the inverter, e.g. Sunny Boy or Sunny Mini Central.

PV Field

See PV array

PV Array

Technical device for the conversion of solar energy into electrical energy. All electrically connected (in series and in parallel) PV modules of a PV system are referred to as the PV array.

PV Module

Electrical connection of several PV cells encapsulated in an enclosure to protect the sensitive cells from mechanical stress and environmental influences.

PV Cell

An electronic component that generates electrical energy when irradiated with sunlight.

Since the electrical voltage of a single PV cell is very low (approximately 0.5 V), multiple PV cells are combined as PV modules. The most common semiconductor material presently used for PV cells is silicon which is manufactured in different forms (monocrystalline, polycrystalline, amorphous). In addition to different mechanical variations, that are usually designed to increase the level of efficiency, completely new materials are currently being tested (cadmium telluride, cadmium indium sulfide, titanium dioxide and many others).

Series Connection

In this case the positive terminal of each battery is connected to the negative terminal of the next battery. There is only one circuit where current can flow. Series connection increases the voltage of the entire battery bank. If four 12 V batteries with a capacity of 100 Ah each are connected in series, the total voltage is $4 \times 12 \text{ V} = 48 \text{ V}$, while the total capacity remains at 100 Ah.

Fast Charge

Boost charge: serves to charge the battery as quickly and efficiently as possible to a state of charge of approx. 85% to 90%.

Self Discharge

Loss of battery charge while it is stored or not used. A higher ambient temperature has a strong influence on self discharge.

SOC

State of Charge: the state of charge of the battery, see State of charge. If 25 Ah is taken from a 100-Ah battery, e.g. the state of charge (SOC) is 75%.

Solar Energy

"Solar energy", this means energy from sunlight or other solar irradiation (heat and/or UV radiation).

Split-Phase

A split-phase system is a three-conductor single-phase distribution system, commonly used in North America, the UK, Australia and New Zealand for single-family residential and light commercial applications up to 100 kVA. Its primary advantage is that it saves conductor material since a single-phase system with one neutral conductor is used, while on the supply side of the grid configuration only one line conductor is necessary. Since there are two live conductors in the system, it is sometimes incorrectly referred to as "two-phase system". To avoid confusion with split-phase applications, it would be correct to call this power distribution system a three-conductor, single-phase, mid-point, neutral system.

String

Describes a group of electrical series-connected PV modules. A PV system usually consists of a number of strings, which avoids yield losses due to variations in shading over different modules.

String Inverter

Inverter concept in which the disadvantages of the central inverter concept are avoided. The PV is split into individual strings, each of which is connected to the external transmission line with its own string inverter. This greatly simplifies installation and greatly reduces the yield losses caused by manufacturing deviations or variations in shading of the PV modules.

Overload Capacity

The overload capacity of an inverter describes its ability to supply short-term (seconds or minutes) excessive loads that can be significantly higher than the nominal power of battery inverters. The overload capacity is necessary in order to be able to also start electronic machines that have a nominal power similar to the nominal power of the inverter in the stand-alone grid, since these machines typically need six times more current during start up in relation to the nominal current.

Full Charge

Recharging of the batteries to a level of approximately 95% on a regular basis (at least once a month). This efficiently avoids premature aging of the batteries caused by inadequate charging.

VRLA

Valve Regulated Lead Acid battery: lead-acid battery with immobilized electrolyte or flooded lead-acid battery. Examples of this type of battery are SLA batteries and AGM batteries (Absorbent Glass Mat).

Inverter

A device for converting the direct current (DC) from the PV array into alternating current (AC), which is necessary for the connection of most devices and especially for the feed-in of solar energy into an existing transmission line. Inverters for PV systems usually include one or more MPP trackers, store operating data and monitor the grid connections of the PV system.

Inverter mode

Operating mode of a battery inverter where it supplies the stand-alone grid from the battery energy. In this operating mode, the battery inverter is especially responsible for the control of frequency and voltage in the stand-alone grid.

Central inverter

An inverter concept in which all PV modules are connected to each other (in series and/or parallel) and which uses a single inverter for feeding energy into the utility grid. The low cost of the inverter is usually offset by the much higher installation efforts required and possible yield losses due to variations in shading of different PV modules.

24 Compliance Information

FCC Compliance

This device complies with Part 15 of the FCC Rules. Operation is subject to the following conditions:

1. This device may not cause harmful interference, and
2. This device must accept any interference received, including interference that may cause undesired operation.

NOTE: This equipment has been tested and found to comply with the limits for a Class B digital device, pursuant to Part 15 of the FCC Rules. These limits are designed to provide reasonable protection against harmful interference in a residential installation. This equipment generates, uses, and can radiate radio frequency energy and if not installed and used in accordance with the instructions, may cause harmful interference to radio communications. However, there is no guarantee that interference will not occur in a particular installation. If this equipment does cause harmful interference to radio or television reception, which can be determined by turning the equipment off and on, the user is encouraged to try to correct the interference by one or more of the following measures:

- Reorient or relocate the receiving antenna.
- Increase the separation between the equipment and the receiver.
- Connect the equipment into an outlet on a circuit different from that to which the receiver is connected.
- Consult the dealer or an experienced radio/TV technician for help.

The user is cautioned that changes or modifications not expressly approved by SMA Solar Technology America LLC could void the user's authority to operate this equipment.

25 Contact

If you have technical problems with our products, please contact the SMA Service Line. We need the following information in order to provide you with the necessary assistance:

- Type of Sunny Island
- Serial number of the Sunny Island
- Firmware version of the Sunny Island
- Displayed error message
- Type of battery connected
- Nominal battery capacity
- Nominal battery voltage
- Communication products connected
- Type and size of additional energy sources
- Type of connected generator
- Power of the connected generator
- Maximum current of the generator
- Interface of the generator

United States/ Estados Unidos	SMA Solar Technology America LLC	+1 877-MY-SMATech (+1 877-697-6283)*
Unidos	Rocklin, CA	+1 916 625-0870**

* toll free for USA, Canada and Puerto Rico / Llamada gratuita en EE. UU., Canadá y Puerto Rico

** international / internacional

SMA Solar Technology

www.SMA-Solar.com

