

Conext™ XWPro

XW Pro 6848 NA

XW Pro 5548 NA

Owner's Guide

990-91227A-01

March 2020

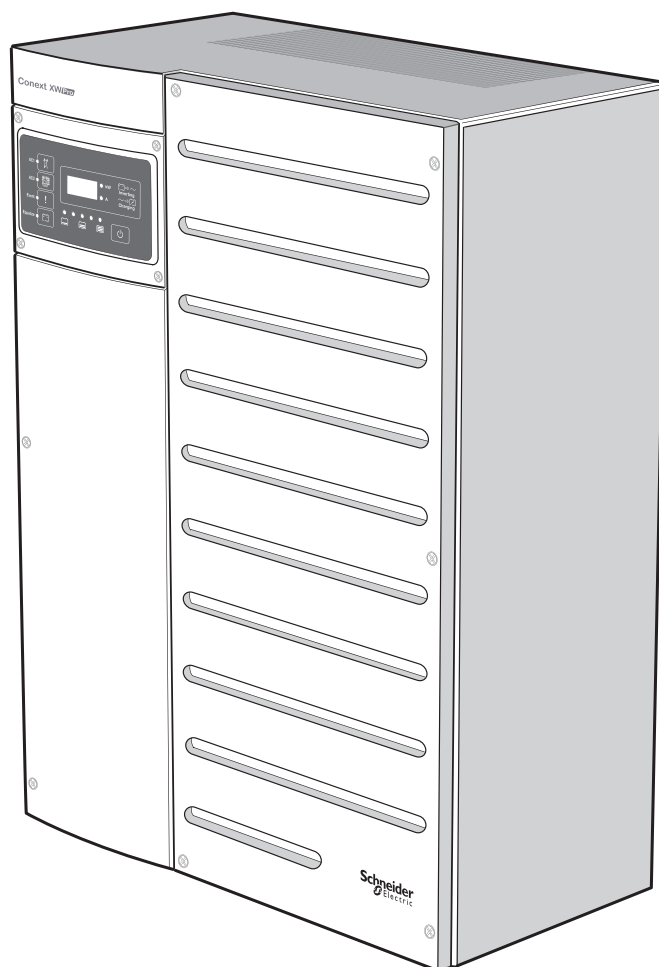

Copyright © 2020 Schneider Electric. All Rights Reserved.

Trademarks are owned by Schneider Electric Industries SAS or its affiliated companies. Other trademarks are owned by their respective companies.

Exclusion for Documentation

UNLESS SPECIFICALLY AGREED TO IN WRITING, SELLER

(A) MAKES NO WARRANTY AS TO THE ACCURACY, SUFFICIENCY OR SUITABILITY OF ANY TECHNICAL OR OTHER INFORMATION PROVIDED IN ITS MANUALS OR OTHER DOCUMENTATION;

(B) ASSUMES NO RESPONSIBILITY OR LIABILITY FOR LOSSES, DAMAGES, COSTS OR EXPENSES, WHETHER SPECIAL, DIRECT, INDIRECT, CONSEQUENTIAL OR INCIDENTAL, WHICH MIGHT ARISE OUT OF THE USE OF SUCH INFORMATION. THE USE OF ANY SUCH INFORMATION WILL BE ENTIRELY AT THE USER'S RISK; AND

(C) REMINDS YOU THAT IF THIS MANUAL IS IN ANY LANGUAGE OTHER THAN ENGLISH, ALTHOUGH STEPS HAVE BEEN TAKEN TO MAINTAIN THE ACCURACY OF THE TRANSLATION, THE ACCURACY CANNOT BE GUARANTEED. APPROVED CONTENT IS CONTAINED WITH THE ENGLISH LANGUAGE VERSION WHICH IS POSTED AT <https://solar.schneider-electric.com>.

Document Number: 990-91227A-01

Date: March 2020

Product Part Number:

XW Pro 6848 NA

865-6848-21

Contact Information

For country-specific details, please contact your local Schneider Electric Sales Representative or visit the Schneider Electric Solar Business website at: <https://solar.schneider-electric.com>

Information About Your System

As soon as you open your product, record the following information and be sure to keep your proof of purchase.

Serial Number _____
Product Number _____
Purchased From _____
Purchase Date _____

READ AND SAVE THESE INSTRUCTIONS

Safety Information

Important Information

Read these instructions carefully and look at the equipment to become familiar with the device before trying to install, operate, service or maintain it. The following special messages may appear throughout this documentation or on the equipment to warn of potential hazards or to call attention to information that clarifies or simplifies a procedure.

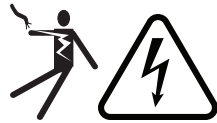

The addition of either symbol to a “Danger” or “Warning” safety label indicates that an electrical hazard exists which will result in personal injury if the instructions are not followed.



This is the safety alert symbol. It is used to alert you to potential personal injury hazards. Obey all safety messages that follow this symbol to avoid possible injury or death.

DANGER

DANGER indicates a hazardous situation which, if not avoided, **will result in** death or serious injury.

WARNING

WARNING indicates a hazardous situation which, if not avoided, **could result in** death or serious injury.

CAUTION

CAUTION indicates a hazardous situation which, if not avoided, **could result in** minor or moderate injury.

NOTICE

NOTICE is used to address practices not related to physical injury.

Please Note

Electrical equipment should be installed, operated, serviced, and maintained only by qualified personnel. No responsibility is assumed by Schneider Electric for any consequences arising out of the use of this material.

A qualified person is one who has skills and knowledge related to the construction, installation, and operation of electrical equipment and has received safety training to recognize and avoid the hazards involved. For more information, see *Audience*.

Label Symbols

NOTE: The term "ground" is equivalent to "earth", and the use of these terms depends on local codes and standards. This document uses the term "ground" throughout.

The following symbols appear on labels on or in the inverter.



Hazardous voltage



Hot surface



Stored energy hazard discharge time



Refer to the Installation or Operation instructions



Protective (grounding) conductor terminal



Direct current

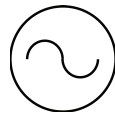

Alternating current

Product Labels

The Conext XW Pro inverter has different product labels designed to provide information on product ratings and specifications, provide safety information, and identify parts and functions of the inverter.

Table 1 Product labels

1	Main product ratings label
2	Front panel label
3	Main product safety label

Main Product Ratings Label

The main product ratings label contains the inverter's product ratings and technical specifications. **Do not remove, cover, deface, or alter the main product label.** A localized main product label is available to install on the product.

Figure 1 Main product ratings label example

Schneider Electric

1 — **Conext XW20 6848 NA**
Inverter/Charger

2 — **Charger Mode (25°C)**

Nominal Input Voltage	120/240V	120V ~
Max. Input Current	48A	48A ~
Input Power Factor	>0,98	>0,98 ~
Input Frequency Range	52-68Hz	52-68Hz ~
Output Voltage Range	40-64V	40-64V ~
Nominal Output Voltage	48.0V	48.0V ~
Max. Output Current	140A	120A =

3 — **Inverter Mode (25°C)**

Nominal Output Voltage	120/240V	120V ~
Nominal Output Frequency	60Hz	60Hz ~
Max. Continuous Output Current	28A	48A ~
Max. Continuous Output Power	6,8kVA	5,76kVA ~
Input Voltage Range	42-60V	42-60V ~
Max. Input Current	180A	180A =

4 — **Grid Interactive Mode (40°C)**

Nominal Grid Voltage	120/240V	120V ~
Grid Voltage Range	211-264V	105,6-132V ~
Nominal Frequency	60Hz	60Hz ~
Output Power Factor	>0,98	>0,98 ~
Max. Continuous Output Current	27A	48A ~
Max. Continuous Output Power	6,0kVA	5,76kVA ~
Input Voltage Range	47-58V	47-58V ~
Max. Continuous Input Current	160A	160A =

5 — Certified for use with 75°C copper conductors

Operating Temperature Range: -25°C to +70°C

Part Number: 865-6848-21

6 — Serial number

7 — Date of Manufacture

This Class B device complies with Part 15 of the FCC Rules and all requirements of the Canadian interference causing equipment regulations. Operation is subject to the following two conditions:

1. This device may not cause harmful interference.
2. This device must accept any interference received, including interference that may cause undesired operation.

Factory Configuration 120/240V, 3 Wire

Optional Configuration 120V, 2 Wire

8 — **IP20** **Type 1, Indoor Use Only** 9

UL 1741
CSA 1021
MC 15949
Listed

UTILITY-INTERACTIVE
INVERTER/CHARGER

All trademarks are owned by Schneider Electric Industries
SAS or its affiliated companies.
www.schneider-electric.com

Designed in Canada Made in Philippines

NOTE: This is for illustration purposes only. Actual ratings vary for each model.

1	Name of the product and model number
2	Charger ratings
3	Inverter ratings
4	Grid interactive ratings
5	Product part number and operating temperature range
6	Product serial number information
7	Product date of manufacture information
8	Regulatory markings
9	Enclosure rating

Front Panel Label

The front panel label contains the LCD display and LED indicators. It also identifies the various buttons used in inverter operation. For information on the indicators and control button, see the *Figure 9 on page 31*.

Figure 2 Inverter Information Panel

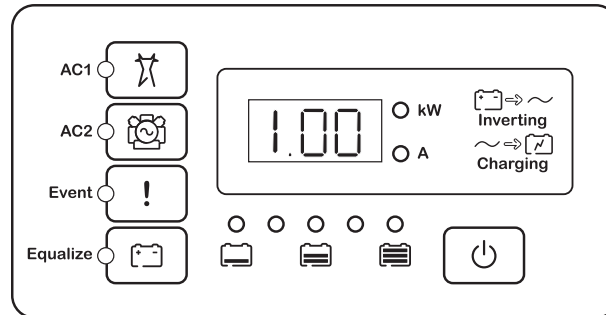

Main Product Safety Label

The main product safety label is the main safety label for the inverter which lists general hazards and instructions on avoiding them. The label is applied on the exterior of the inverter.

Do not remove, cover, deface, or alter the main product safety label. A localized label is available to install on the product.

For information on the symbols appearing in the label, see *Label Symbols on page 4*.

Other Safety Labels

Other safety labels appear on many areas of the equipment to warn of potential hazards within those areas of the inverter or to call attention to information that clarifies or simplifies a procedure. Read and follow all safety labels before proceeding.

Do not remove, cover, deface, or alter safety labels. Localized safety labels are available to install on the product.

For information on the symbols appearing in the label, see *Label Symbols on page 4*.

Radio Frequency Interference Notices

Federal Communications Commission (FCC)

This equipment has been tested and found to comply with the limits for a Class A digital device, pursuant to part 15 of the FCC Rules. These limits are designed to provide reasonable protection against harmful interference in a residential installation. This equipment generates, uses, and can radiate radio frequency energy and, if not installed and used in accordance with the instructions, may cause harmful interference to radio communications. However, there is no guarantee that interference will not occur in a particular installation. If this equipment does cause harmful interference to radio or television reception, which can be determined by turning the equipment off and on, the user is encouraged to try to correct the interference by one or more of the following measures:

- Reorient or relocate the receiving antenna.
- Increase the separation between the equipment and the receiver.
- Connect the equipment to a circuit different from that to which the receiver is connected.
- Consult the dealer or an experienced radio/TV technician for help.

Audience

This guide is intended for use by anyone needs to operate, configure, and troubleshoot the Conext XW Pro inverter/charger. Certain configuration tasks should only be performed by qualified personnel in consultation with your local utility and/or an authorized dealer. Electrical equipment should be installed, operated, serviced, and maintained only by qualified personnel. Keep unqualified personnel away from batteries. Servicing of batteries must only be performed or supervised by qualified personnel with knowledge of batteries and their required precautions. Qualified personnel have training, knowledge, and experience in

- Installing electrical equipment.
- Applying all applicable installation codes.
- Analyzing and reducing the hazards involved in performing electrical work.
- Installing and configuring batteries.
- Selecting and using Personal Protective Equipment (PPE).

This guide does not contain information regarding servicing or de-energization for servicing. No responsibility is assumed by Schneider Electric for any consequences arising out of the use of this material.

About

Purpose

This guide provides explanations and procedures for operating the Schneider Electric Conext XW Pro inverter/charger.

- Installation instructions are available in the *Conext XW Pro Installation Guide* (document number 990-91228)
- Instructions for configuring inverter settings are available in this guide.

For explanations and procedures related to other products, please contact the manufacturer of those products.

Scope

This guide provides safety guidelines and information about operating the Conext XW Pro inverter/charger.

The Owner's Guide provides safety guidelines and information about operating the Conext XW Pro inverter/charger and related system components. It does not provide details about installation, maintenance, or servicing. See the Operation Guide or Owner's Guide of each device for this information. This Owner's Guide does not provide details about particular brands of batteries, photoelectric cells, or generators. Consult individual battery manufacturers for this information.

Abbreviations and Acronyms

CEC	California Energy Commission
CSA	Canadian Standards Association
GT	Grid Tie
LCD	Liquid Crystal Display
LED	Light Emitting Diode
MPPT	Maximum Power Point Tracking
NEC	US National Electrical Code NFPA-70
PV	Photovoltaic
PVGFP	PV Ground Fault Protection
UL	Underwriters Laboratories
VAC	Volts Alternating Current
VDC	Volts Direct Current

Related Information

Find more information about Schneider Electric, as well as its products and services at:
www.schneider-electric.com.

For specific information about Schneider Electric Solar products, visit:
<https://solar.schneider-electric.com>.

For available accessories, see the *Conext XW Pro Installation Guide* (document number 990-91228).

Product Safety Information

IMPORTANT: Remember to read and follow all product safety information in this document.

General Safety Instructions

Before using the inverter/charger, read all instructions and cautionary markings on the unit, the batteries, and all appropriate sections of this manual.

- Use of accessories not recommended or sold by the manufacturer may result in a risk of fire, electric shock, or injury to persons.
- The inverter/charger is designed to be permanently connected to your AC and DC electrical systems. The manufacturer recommends that all wiring be done by a certified technician or electrician to ensure adherence to the local and national electrical codes applicable in your jurisdiction.
- To avoid a risk of fire and electric shock, make sure that existing wiring is in good condition and that wire is not undersized. Do not operate the inverter/charger with damaged or substandard wiring.
- Do not operate the inverter/charger if it has been damaged in any way.
- Most of the parts in this unit are not user-serviceable parts. Do not disassemble the inverter/charger except where noted for connecting wiring and cabling. See your warranty for instructions on obtaining service. Attempting to service the unit yourself may result in a risk of electrical shock or fire. Internal capacitors remain charged after all power is disconnected.
- To reduce the risk of electrical shock, disconnect both AC and DC power from the inverter/charger before attempting any maintenance or cleaning or working on any components connected to the inverter/charger. Putting the unit in Standby mode will not reduce this risk.
- The inverter/charger must be provided with an equipment-grounding conductor connected to the AC input ground.
- Do not expose this unit to rain, snow, or liquids of any type. This product is designed for indoor use only. Damp environments will significantly shorten the life of this product and corrosion caused by dampness will not be covered by the product warranty.
- To reduce the chance of short-circuits, always use insulated tools when installing or working with this equipment.
- Remove personal metal items such as rings, bracelets, necklaces, and watches when working with electrical equipment.
- Do not expose this unit to excessive shock or vibration. This product is designed for stationary indoor use only. Mechanical fatigue caused by excessive shock or vibration can significantly shorten the life of this product and will not be covered by the product warranty.

 **DANGER****HAZARD OF ELECTRIC SHOCK, EXPLOSION, ARC FLASH, AND FIRE**

This document is in addition to, and incorporates by reference, the relevant product manuals for Conext XW Pro inverter/charger. Before reviewing this document, you must read the relevant product manuals. Unless specified, information on safety, specifications, installation and operation is as shown in the primary documentation received with the product. Ensure you are familiar with that information before proceeding.

Failure to follow these instructions will result in death or serious injury.

 **DANGER****HAZARD OF ELECTRIC SHOCK, EXPLOSION, ARC FLASH, AND FIRE**

- Apply appropriate personal protective equipment (PPE) and follow safe electrical work practices. See NFPA 70E or CSA Z462.
- This equipment must only be installed and serviced by qualified electrical personnel.
- Never operate energized with covers removed
- Energized from multiple sources. Before removing covers identify all sources, de-energize, lock-out, and tag-out and wait 5 minutes for circuits to discharge
- Always use a properly rated voltage sensing device to confirm all circuits are de-energized.

Failure to follow these instructions will result in death or serious injury.

 **DANGER****HAZARD OF ELECTRIC SHOCK, EXPLOSION, ARC FLASH, AND FIRE**

- Disconnect negative and positive DC conductors before servicing. DC conductors are to be treated as Hazardous Live and must be disconnected.
- Normally GROUNDED conductors may be UNGROUNDED and ENERGIZED when a GROUND FAULT is indicated on the front panel. Must be serviced by qualified personnel.

Failure to follow these instructions will result in death or serious injury.

Precautions when Working with Batteries

NOTE: Battery work and maintenance must be done by qualified personnel knowledgeable about batteries to help ensure compliance with battery handling and maintenance safety precautions.

DANGER

HAZARD OF ELECTRIC SHOCK, EXPLOSION, OR ARC FLASH

- Remove watches, rings, or other metal objects.
- This equipment must only be installed and serviced by qualified electrical personnel.
- Keep sparks and flames away from the batteries.
- Use tools with insulated handles.
- Wear protective glasses, gloves and boots.
- Do not lay tools or other metal parts on top of batteries.

Failure to follow these instructions will result in death or serious injury.

DANGER

HAZARD OF ELECTRICAL SHOCK, EXPLOSION, OR FIRE

- Battery Circuit Breakers must be installed according to the specifications and requirements defined by Schneider Electric.
- Servicing of batteries must only be performed by qualified personnel knowledgeable about batteries and the required precautions. Keep unqualified personnel away from batteries.
- Disconnect the charging source prior to connecting or disconnecting battery terminals.

Failure to follow these instructions will result in death or serious injury.

Limitations on Use

WARNING

HAZARD DUE TO UNINTENDED USE

The Conext XW Pro inverter is not intended for use in connection with life support systems or other medical equipment or devices. The Conext XW Pro inverter can only be used in grid-interconnected, off grid, and integrated PV systems. It is not suitable for any other application areas.

Failure to follow these instructions can result in death, serious injury, or equipment damage.

Explosive Gas Precautions

WARNING

EXPLOSION HAZARD

The Conext XW Pro is not ignition protected. To prevent fire or explosion, do not install this product in locations that require ignition-protected equipment. This includes any space containing gasoline-powered machinery, fuel tanks, as well as joints, fittings, or other connections between components of the fuel system.

Failure to follow these instructions can result in death, serious injury, or equipment damage.

Working in the vicinity of lead acid batteries is dangerous. Batteries generate explosive gases during normal operation. Therefore, you must read this Owner's Guide and follow the instructions exactly before installing or using your inverter/charger.

To reduce the risk of battery explosion, follow these instructions and those published by the battery manufacturer and the manufacturer of the equipment in which the battery is installed.

Contents

Safety Information	3
Label Symbols	4
Product Labels	5
Radio Frequency Interference Notices	8
Audience	9
About	10
Purpose	10
Scope	10
Abbreviations and Acronyms	10
Related Information	11
Product Safety Information	12
General Safety Instructions	12
Precautions when Working with Batteries	14
Limitations on Use	14
Explosive Gas Precautions	15
Introduction	21
Features	22
Performance Highlights	22
Distinguishing Features	22
Available Conext XW Pro Accessories	23
Regulatory Certification	23
Operation	24
Bidirectional Theory of Operation	24
Surge Performance	27
Islanding Protection	27
AC Coupling	28
Multi-unit Operation	29
Auxiliary Output	30
Transfer Relays	30
Monitoring the Conext XW Pro	31
Conext XW Pro Information Panel	31
Conext Gateway	32
Conext Configuration Tool	32
Monitoring Operation	33
Monitoring Operation with the Inverter Information Panel	34
Monitoring AC Input Status	35
Monitoring Conext XW Pro Status	35

Monitoring Charger Status	36
Monitoring Events	36
Equalizing Batteries	36
Using Startup/Shutdown/Standby Modes	38
Monitoring Battery Level	40
Reading the Display Screen	41
Monitoring Operation with the Conext Gateway	41
Accessing the Device in the Web Application	41
Status Page	41
Performance Page	45
Events Page	45
External Monitoring Control	47
Overview	48
SunSpec Modbus	48
Power Limiting	48
Communications Loss	48
IEEE2030.5	49
Configuration	51
Configuration with the Conext Gateway Web Application	52
Accessing the Web Application	52
Setting the Device Name	53
Setting the Device Number	53
Setting the Time and Date	54
Conext XW Pro Configuration Page	54
Controls Settings	54
Inverter Settings	55
Charger Settings	59
AC Settings	73
Grid Support Settings	75
Generator Support Settings	78
Auxiliary Output Settings	80
Multi-Unit Configuration Menu	83
Associations Settings	85
Advanced Features	87
Advanced Device Settings	89
Battery Management System Settings	89
Device Instance Settings	91
Modbus Settings	92

Prioritizing and Managing Energy Sources with Advanced Features	93
Grid Support	93
Charger Block	96
Peak Load Shaving (PLS)	96
Managing Firmware	98
Managing Compliance Regions	99
Resetting the Conext XW Pro to Default Settings	100
Troubleshooting	101
General Troubleshooting Guidelines	102
Inverter Applications	103
Resistive Loads	103
Motor Loads	103
Problem Loads	103
Inverter Troubleshooting	105
Battery Charger Troubleshooting	108
Faults and Warnings	110
Warning Messages	110
Fault Messages	113
Specifications	121
Electrical Specifications	122
Mechanical Specifications	123
Conext XW Pro Overload Capability	125
Output Power Versus Ambient Temperature	127
Conext XW Pro Efficiency	128
Regulatory Approvals	129
Grid Support Utility Interactive Functions	130
California Rule 21: Smart Inverter Grid-Support Utility Interactive Functions ..	130
Hawaiian Electric Company (HECO) Rule No. 14: Smart Inverter Grid-Support Utility Interactive Functions	142
IEEE 1547-2003 Standard for Interconnecting Distributed Resources with Electric Power System (60Hz and 50Hz)	156
Puerto Rico Energy Power Authority (PREPA) Technical Requirements for Interconnecting Wind and Solar Generation	170
Defaults	183
Default Settings	184

1 Introduction

What's in This Chapter?

Features	22
Performance Highlights	22
Distinguishing Features	22
Available Conext XW Pro Accessories	23
Regulatory Certification	23
Operation	24
Bidirectional Theory of Operation	24
Surge Performance	27
Islanding Protection	27
AC Coupling	28
Multi-unit Operation	29
Auxiliary Output	30
Transfer Relays	30
Monitoring the Conext XW Pro	31
Conext XW Pro Information Panel	31
Conext Gateway	32
Conext Configuration Tool	32

Features

The Conext XW Pro is a modular building block sine-wave inverter/charger that can be used for residential and commercial battery based off-grid, grid backup, and grid interactive applications.

The Conext XW Pro is a self-contained DC to AC inverter, battery charger, and integrated AC transfer switch. It is configurable in a hybrid system to operate with generators and renewable energy sources. These configurations are capable of extending battery based off-grid/backup autonomy.

Performance Highlights

- High-capacity motor load starting with high 30-minute and 5-second power.
- Off-grid AC Coupling with PV inverters using frequency power curtailment method.
- Operation in hot environments up to 40°C without derating.
- Conversion of DC energy to AC energy for export to the utility grid.
- Power factor corrected charging minimizes AC current required for charging.
- Very low distortion sine wave output.

Distinguishing Features

- Grid-interactive feature set enables time management and prioritization of energy sources and power conversion to support advanced modes of operation such as load shifting, self consumption and peak load shaving.
- Dual AC input connections with 60 A automatic transfer switch integrates both utility grid and generator.
- Generator Support functionality assists small generators with heavy loads.
- Auxiliary port assist with relay switching of external devices such as battery room fans, diversion loads and generators.
- Configurable battery parameters for customized battery charging.
- Field serviceable boards and components.

Xanbus™ Network Communications Protocol

The Conext XW Pro uses Xanbus™, a network communications protocol developed by Schneider to communicate with other Xanbus-enabled devices. You can configure and monitor the Conext XW Pro and other Xanbus-enabled devices in the system using the Conext Gateway (part number 865-0329).

Available Conext XW Pro Accessories

Accessory	Part Number
Conext XW Pro Power Distribution Panel	865-1015-01
Conext XW Pro Power Distribution Panel (Without AC Breakers)	865-1014-01
Conext XW Pro Conduit Box	865-1025-01
Conext XW Pro PDP 120/240V 60A Breaker Kit	865-1215-01
Conext Gateway	865-0329
Conext Configuration Tool	865-1155-01
Conext AGS Automatic Generator Start	865-1060-01
Conext MPPT solar charge controller MPPT 60 150	865-1030-1
Conext MPPT solar charge controller MPPT 80 600	865-1032
Conext Battery Monitor	865-1080-01

Regulatory Certification

Conext XW Pro inverter qualifies as a Smart Inverter¹ and complies with multiple jurisdictions grid interconnection standard requirements that are currently in effect in different jurisdictions:

- UL1741, 2nd Edition -2018 ("UL1741SA")
- CSA 107.1-2016
- IEEE 1547-2003 Standard for Interconnecting DER with Electric Power Systems, see *"IEEE 1547-2003 Standard for Interconnecting Distributed Resources with Electric Power System (60Hz and 50Hz)" on page 156*
- IEEE 1547.1-2005
- IEEE 1547a-2014 (Amd 1)
- California Rule 21, see *"California Rule 21: Smart Inverter Grid-Support Utility Interactive Functions" on page 130*
- Hawaiian Electric Company (HECO), see *"Hawaiian Electric Company (HECO) Rule No. 14: Smart Inverter Grid-Support Utility Interactive Functions" on page 142*
- Puerto Rico Energy Power Authority (PREPA), see *"Puerto Rico Energy Power Authority (PREPA) Technical Requirements for Interconnecting Wind and Solar Generation" on page 170*

¹ A Smart Inverter is a Distributed Energy Resource (DER) that autonomously performs functions that minimize the risk of unstable grid operations by providing dynamic active and reactive power support, voltage and frequency ride-through, ramp-rate control and other functions.

Operation

Bidirectional Theory of Operation

NOTICE

EQUIPMENT DAMAGE

- The Automatic Transfer Relays are rated at 60 A.
- Loads connected at AC OUT must not exceed the inverter's overload ratings or the 60 A limit, whichever is lower. Unless an external contactor or external transfer switch is used, the 60 A limit also applies to loads connected to the AC OUT bus of multiple inverters connected in parallel.

Failure to follow these instructions can result in equipment damage.

The Conext XW Pro is a grid forming device consisting of a bidirectional inverter/charger. It is capable of inverting DC power into AC power and controlling the voltage and frequency of its inverter output. It will power external loads attached to AC OUT, see *Figure 4 on page 25*.

The Conext XW Pro is also capable of charging external batteries by converting AC power into DC power, see *Figure 5 on page 25*. The Conext XW Pro accepts AC power through connection AC2 for charging batteries, usually from a generator, see *Figure 6 on page 26*.

The Conext XW Pro will convert externally sourced DC power into AC power for export to the utility grid attached to its AC1 connection, see *Figure 7 on page 26*.

The Conext XW Pro has internal automatic transfer switches (K1, K2), rated at 60 A, which allow either AC1 or AC2 to be connected to the inverter input, but not both at the same time, see *Figure 3 on page 25*. This allows shared AC energy during charging or to directly passthrough from AC1, or AC2, to AC Out.

Through firmware control over power conversion and the management of K1 and K2, Conext XW Pro can facilitate advanced interaction with the utility grid to optimize the utilization of renewable and non-renewable energy sources. Because the Conext XW Pro is a device capable of forming an AC grid signal (AC voltage and frequency) it is also ideal for use off-grid.

The red arrows in the diagrams below represent the direction of power flow in the respective modes of operation. These modes and other special functions will be explained throughout this manual.

Figure 3 Connection Points and Major Power Conversion Components of Conext XW Pro

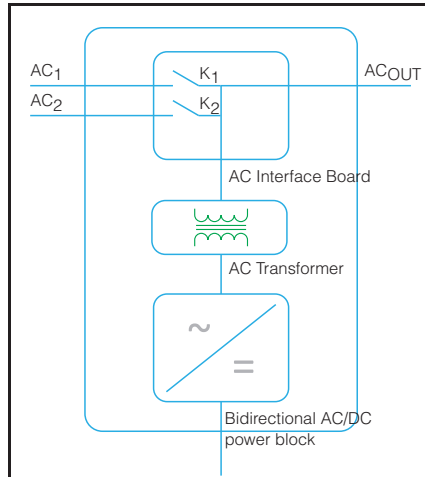

Figure 4 Inverting of DC to AC Connected to AC OUT

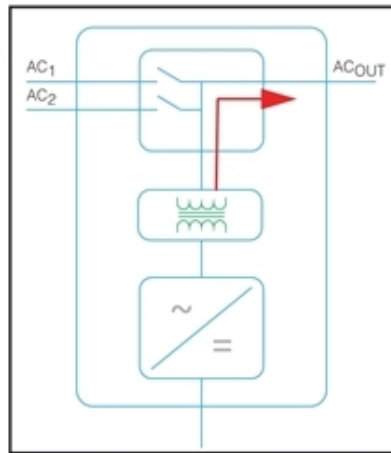

Figure 5 Charging External Batteries and Supplying AC Out with AC Passthrough from AC1 Grid

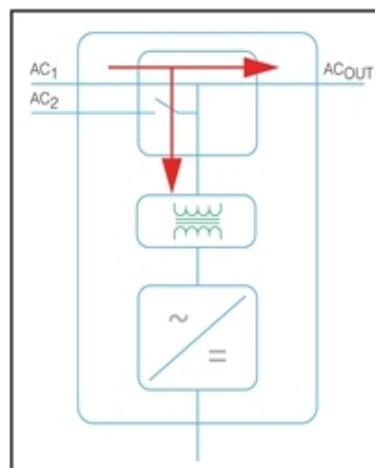

Figure 6 Charging External Batteries and Supplying AC Out with AC Passthrough from AC2 Generator

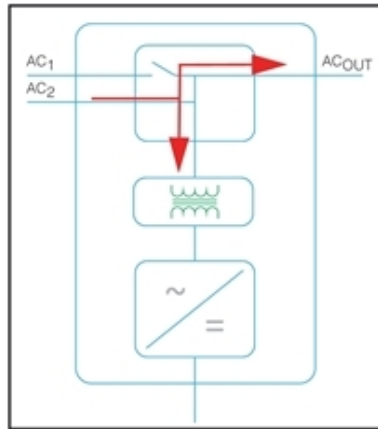

Figure 7 Converting Excess Available DC power for Export to Utility Grid (AC1) and AC Out

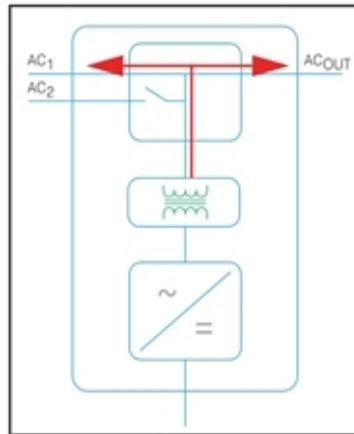
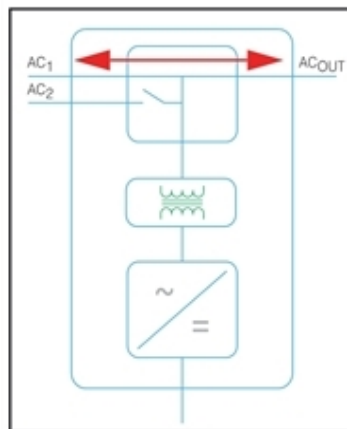

Figure 8 AC Passthrough



Surge Performance

Unlike many other inverters, the Conext XW Pro helps stop voltage from sagging dramatically during surge conditions. The Conext XW Pro handles surges of over twice its rated output power with only a minimal drop in output voltage for limited periods of time.

Islanding Protection

Islanding protection is an essential safety feature that helps reduce harm to those working on the utility grid from a distributed energy source such as the Conext XW Pro. Islanding protection also helps to prevent loads connected to the Conext XW Pro from being damaged by a fluctuating utility grid input. The Conext XW Pro uses proprietary positive feedback control to achieve anti-islanding operation while maintaining low total harmonic distortion at the grid connection. Default software settings are programmed into each Conext XW Pro at the factory so that they comply with applicable safety regulations (such as IEEE 1547 and UL 1741 in North America).

In some instances it may be desirable from both a utility and a customer point of view to adjust the default anti-islanding settings. For example, the Conext XW Pro may experience “nuisance trips” if the grid is weak and the voltage falls outside the allowable range specified by regulations. It may be difficult for a utility to adjust the grid to stop this problem. With permission from the utility, the factory settings may be changed to allow the Conext XW Pro to operate over a wider grid voltage range. These settings must only be changed by qualified service personnel using either Conext Gateway or a special software application (Conext XW Pro Configuration Tool, Order # 865-1155-01) provided by the manufacturer.

While exporting energy, the Conext XW Pro continuously monitors the utility grid voltage and frequency. If the grid voltage or frequency move beyond the Conext XW Pro default ranges (for example, during a power surge or outage) the Conext XW Pro stops exporting energy through AC1 and disconnects from the utility. If disconnected due to a grid voltage disturbance, five minutes is the non-adjustable minimum reconnect time during which the Conext XW Pro does not export energy through AC1 to the grid. The Event LED on the Conext XW Pro information panel will indicate a utility fault. No fault code appears on the three-character display because the fault is with the utility grid, not with the Conext XW Pro.

In addition to the information panel, the Conext Gateway web application indicates any utility faults with details present under all affected instances of Conext XW Pro. The faults cannot be manually cleared. Utility faults will clear automatically when the utility grid voltage and frequency return to within the ranges programmed into the Conext XW Pro. If grid support is enabled and the utility voltage and frequency come back within tolerance, the Conext XW Pro information panel displays a countdown timer for five minutes until the Conext XW Pro can start interacting with the grid again.

AC Coupling

Off-grid AC Coupled system architecture is often used to create a stand-alone grid. Commonly this means that PV inverters are connected to the output of a battery-based inverter/charger putting both on the same AC bus along with the AC loads. In this scenario, the battery powered inverter charger provides the necessary frequency and voltage to enable the PV inverter to produce power. This type of system must be able to maintain power generation in balance with power consumption at all times. If there is more power being generated than can be consumed by the loads, power will flow to the inverter/charger and be converted to DC power which flows into the battery. Once the battery reaches capacity, power generation by the PV inverter must be curtailed to maintain the balance between generation and consumption. As the battery bank reaches capacity, Conext XW Pro curtails PV inverter generation by raising the AC line frequency causing compatible PV inverters to reduce their power output in an orderly manner. This is called Active Frequency Shift Power Curtailment. In some compliance regions, when the grid returns from an outage, Conext XW Pro will cause any AC coupled PV inverter to transition offline via the same mechanism prior to grid reconnection.

During a grid outage even a home with a grid-tie PV inverter system will be without power because PV inverters cannot produce power without the presence of a reference voltage and frequency. To enable the PV inverter to provide power during a grid outage the Conext XW Pro is retrofitted in front of the PV inverter. The PV inverter is rewired from the grid connection to a critical load (sub) panel and is AC Coupled to the Conext XW Pro AC Output port. When the grid is present, PV inverter power feeds the loads and any excess is exported by Conext XW Pro to the grid using AC1 (where permitted by the local utility). During a grid outage, Conext XW Pro anti-islanding protection helps to prevent power from being exported to grid on AC1. Conext XW Pro then uses Active Frequency Shift Power Curtailment to reduce the power output of compatible PV inverters, maintaining the balance of generation and consumption.

Consult the manufacturer's specifications to determine if your PV inverter is compatible with Active Frequency Shift Power Curtailment. Conext XW Pro AC coupling function is enabled by default (Advanced Features Menu).

NOTICE

AC COUPLED PV INVERTER COMPATIBILITY

AC power generated by AC coupling PV inverters with Conext XW Pro must be consumed by AC loads or used to charge batteries. As an alternative, the excess power produced from a PV inverter can be routed to dump loads. Do not AC couple PV inverters with the Conext XW Pro that are unable to reduce, derate or cease the excess PV inverter power in response to the changes in AC line frequency controlled by the Conext XW Pro. Consult the manufacturer's specifications of your PV inverter and confirm compatibility.

Failure to follow these instructions can result in equipment damage.

The AC coupling advanced setting should remain enabled except in cases when the DC voltage level is allowed to have large variations and the line frequency needs to remain constant.

Further details about AC Coupling can be found in the document *AC Coupling of Inverters Solutions Guide (976-0240-01-01)* available at <http://solar.schneider-electric.com>.

Multi-unit Operation

Important: An external transfer switch may be required to protect the internal relays from the combined loads of the system. For more information, see the Conext XW Pro Multi-unit Power System Design Guide (document number 990-91373).

Up to three Conext XW Pro units can be installed together in a split phase configuration with the Conext XW Pro PDP (Power Distribution Panel). The PDP is an ideal optional companion for managing AC connections and integrating a battery bank and other DC connections.

Multiple Conext XW Pro units and other Xanbus devices with common connections to battery banks, PV arrays, the utility grid or a generator require programming during commissioning to enable correct operation.

Inverting

For multiple units, the master Conext XW Pro synchronizes operation of other connected units using the same Xanbus network. When AC loads are present, all units produce power. Refer to the Conext XW Pro Multi-unit Power System Design Guide (document number 990-91373) for total system surge ratings.

Parallel Charging

Multiple Conext XW Pro units on the same Xanbus network synchronize their charging stages to help provide efficient charging of the battery bank. When a single unit transitions from bulk to absorption, so do all other units. In absorption, all units must complete the absorption stage before any of them transition to the next stage. Note that units stop sharing charge current just before completing the bulk stage and only share charging load during the bulk stage.

Each Conext XW Pro unit provides a maximum charging current set by the `Max Charge Rate` setting. The maximum current may be decreased, subject to the internal operating temperature.

When one or more Conext Solar Charge Controllers are installed and operating in the system, Conext XW Pro units synchronize only their bulk charging stage with the charge controllers.

Note: Equalization is device specific. Only the device(s) on which equalization was initiated will perform the equalization. Other devices will stay in float or no-float depending on their settings.

AC Transfer

Multiple Conext XW Pro units monitor each other to determine the quality of AC input. If AC input is deemed to be bad by any of the paralleled units, no transfer to AC Out occurs and the AC LED continues to flash on each unit's information panel until the AC is

qualified by all. If the system was in passthrough and AC fails on any unit, all units transfer to invert simultaneously.

Faults

When the Conext XW Pro detects a fault condition, the fault is displayed on the Conext XW Pro. The Conext XW Pro also turns on the Event LED on the Conext XW Pro and inverter information panel. A fault affects the operation of the unit. See *"Fault Types"* on page 113 for an explanation of the different fault types.

When a single Conext XW Pro slave unit in a multi-unit system has a fault, only the affected device shuts down.

When a master unit has an invert mode fault that causes it to stop inverting, it is considered a system-wide fault and all units shut down. Invert mode faults on slave units only shut down the affected slave unit.

All units shut down when there is a battery-related fault such as battery over-temperature or over-voltage.

Independent Operation of Features

Each Conext XW Pro grid-interactive feature (e.g. enhanced grid support, grid sell, load shave and generator support) operates independently. This enables Conext XW Pro units in a multi-unit system to be configured to perform multiple functions independently and allows greater flexibility in operating the entire system.

Auxiliary Output

Each Conext XW Pro has one programmable 12 V, 0.25 A auxiliary output that is able to run a small fan or operate an external relay to perform other functions. Examples include remotely starting a two-wire start generator in cases where the Xanbus-enabled Conext XW Pro AGS is not used, disconnecting external non-critical loads, or turning on a diversion load for battery voltage regulation. See *"Auxiliary Output Settings"* on page 80 for programming parameters.

Transfer Relays

The built-in transfer relays, designated K1 and K2, are each is rated for 60 amps. Connected loads must not draw currents exceeding this. When an external AC source is detected and qualified on either of the AC1 or AC2 inputs, the relay transfers loads from the Conext XW Pro to the external power source, and then activates the battery charger. The Conext XW Pro design does not allow the K1 and K2 relays to close simultaneously. This design helps stop the generator input (AC2) from back feeding to the utility grid (AC1). Multi-unit systems of three or more require the use of an external AC contactor to manage the AC bus.

Monitoring the Conext XW Pro

Operation of the Conext XW Pro can be monitored using the factory-installed inverter information panel or the optional Conext Gateway. To configure the Conext XW Pro, operators must use the Conext Gateway and service personnel can use the Config Tool or Conext Gateway.

Conext XW Pro Information Panel

The Conext XW Pro information panel features:

- Buttons for Conext XW Pro Startup/Shutdown/Standby control, clearing faults and warnings, and battery equalization.
- A three-character display to indicate power output, charge current, anti-islanding countdown or troubleshooting information.
- LEDs to indicate AC input status, output status, battery condition, and system warnings/faults.

Figure 9 Conext XW Pro Information Panel

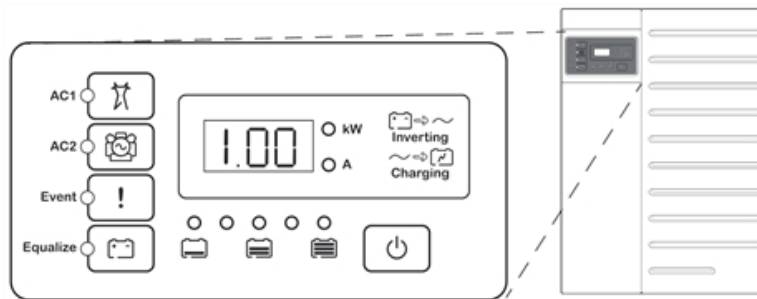

Symbol	Description
	AC input status.
	Second AC input status.
	Event status.
	Equalizing status.
	Battery level of charge.
	STARTUP/SHUTDOWN button.
	Charging status.
	Inverting status.

Conext Gateway

The Conext Gateway is a multi-function communication device that provides an overall view of system performance for residential power monitoring systems. It also provides a communications gateway between a network of Xanbus™-enabled devices and Modbus devices, including third-party controllers. It is the primary tool for monitoring and configuring all Xanbus-enabled devices.

Conext Configuration Tool

The Conext Configuration Tool is used by system installers to simplify the task of system configuration and reduce installation time. It is a PC-based software tool that works on Conext series devices and peripherals.

2 Monitoring Operation

What's in This Chapter?

Monitoring Operation with the Inverter Information Panel	34
Monitoring AC Input Status	35
Monitoring Conext XW Pro Status	35
Monitoring Charger Status	36
Monitoring Events	36
Equalizing Batteries	36
Using Startup/Shutdown/Standby Modes	38
Monitoring Battery Level	40
Reading the Display Screen	41
Monitoring Operation with the Conext Gateway	41
Accessing the Device in the Web Application	41
Status Page	41
Performance Page	45
Events Page	45

Monitoring Operation with the Inverter Information Panel

The inverter information panel on each Conext XW Pro monitors a single Conext XW Pro. The Conext XW Pro information panel displays basic information and performs start up, shut down, equalization and standby functions. LEDs on the information panel indicate AC input status, Conext XW Pro status, battery condition, and charging and equalization status. The Conext XW Pro LEDs and three-character display screen indicate warning and event conditions.

Figure 10 Inverter Information Panel

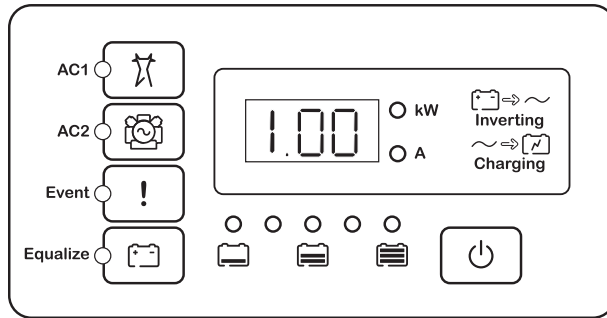

Symbol	Description
	AC input status.
	Second AC input status.
	Event status.
	Equalizing status.
	Battery level of charge.
	STARTUP/SHUTDOWN button.
	Charging status.
	Inverting status.

Monitoring AC Input Status

Grid (AC1)

The green Grid (AC1) LED indicates the presence and status of the AC source connected to the AC1 input.

Symbol	LED On	LED Flashing	LED Off
	AC input is present and qualified. The Conext XW Pro is ready to charge batteries, pass AC through to the loads, or interact with the grid.	AC input is present and is being qualified.	The Conext XW Pro is not connected to the grid. AC input is not present, or AC input is present but not within qualifying range.

Gen (AC2)

The green Gen (AC2) LED indicates the presence and status of a generator or other auxiliary AC source on the AC2 input.

Symbol	LED On	LED Flashing	LED Off
	The AC source is present and AC input is qualified. The Conext XW Pro is ready to charge batteries and pass power through to the loads.	AC input is present and is being qualified.	AC input is not present, or AC input is present but not within qualifying range.

When one AC input LED is on and the other AC input LED is flashing, AC input is present on both AC1 and AC2. However, the Conext XW Pro can qualify and receive AC input from only one source at a time. The qualified source is represented by the steadily lit LED. When two sources of AC input are present, the Conext XW Pro uses the source selected under **AC Priority** in the **AC Settings** menu.

Monitoring Conext XW Pro Status

The Green kW LED indicates the Conext XW Pro is inverting DC input to AC output. When this LED is on or flashing, the display screen shows Conext XW Pro output power in kilowatts.

Symbol	LED On	LED Flashing	LED Off
	The Conext XW Pro is inverting and generating an AC output. Display screen shows output power in kW.	The Conext XW Pro is in Grid Support mode. Display screen shows output power in kW.	The Conext XW Pro is not inverting.

Monitoring Charger Status

The green LED labelled “A” indicates the Conext XW Pro is charging the battery bank. When this LED is on, the numeric display screen shows battery charging current in amps.

Symbol	LED On	LED Flashing	LED Off
	The Conext XW Pro is charging the battery bank. The numeric display screen shows battery charging current in amps.	AC coupled charging is occurring ^a . May flash in AC coupled mode where reverse current greater than 3 A is present. Multiple units are connected in parallel under no load.	The Conext XW Pro is not in charge mode.

When a charge cycle ends or charging is manually disabled, the Conext XW Pro does not leave charge mode immediately, and the charging LED remains on for 60 seconds.

Monitoring Events

The Red Event LED indicates the presence of a fault or warning in the system. To clear active events, briefly press and release the STARTUP/SHUTDOWN button n (see *Figure 10 on page 34*).

Symbol	LED On	LED Flashing
	The Conext XW Pro has stopped charging or inverting due to a event. The LED also turns on steadily if the unit has both a fault and a warning.	The Conext XW Pro has a warning. A warning may escalate to a fault if the warning condition does not go away.

Equalizing Batteries

Button

Pressing the Equalize button ( symbol) for five seconds initiates a battery equalization cycle. This cycle is used to restore battery capacity when battery life has deteriorated due to sulphation. After the button is pressed the Conext XW Pro begins a full charge cycle, which is automatically followed by an equalization cycle. Equalization functions only when AC is present and qualified and the charger is enabled. Otherwise the Conext XW Pro generates a **Cannot Equalize** warning (W96).

^aSee the document “AC Coupling of Inverters Solutions Guide” available at <http://solar.schneider-electric.com> for more information about AC coupling.

⚠ WARNING**EQUALIZATION HAZARD**

- Only lead acid batteries permitted by the manufacturer should be equalize charged. Hydrogen and oxygen gases are produced when batteries are equalized and can potentially cause an explosion if ignited. Corrosive battery acid can escape.
- Provide adequate ventilation and remove all sources of ignition, such as open flames, sparks, electric motors, relays, light switches, etc.
- Equalization voltage is significantly higher than nominal battery voltage. Detach electronics that can be damaged by high DC voltage.

Failure to follow these instructions can result in death, serious injury, or equipment damage.

⚠ WARNING**BATTERY TYPE AND SETUP HAZARDS**

- Incorrect battery configurations or settings for battery types can lead to dangerously high battery temperature, fire and explosion. To avoid damaging your batteries during charging or equalization, and to minimize the risk of fire or explosion consult battery manufacturer's documentation before setting battery parameters and follow the battery manufacturer's recommended settings.
- Always use and connect the Battery Temperature Sensor (BTS) unless an external BMS fulfilling this function is used.
- Always verify that the configured battery type matches the battery type being used.
- Custom battery settings should be configured by qualified personnel only.
- When using Lithium-Ion batteries, ensure that the battery pack being used includes a Battery Management System (BMS) with safety controls. Refer to Li-Ion Battery Technical Note (document number 990-6359) for additional information.

Failure to follow these instructions can result in death, serious injury, or equipment damage.

In a system where more than one device is capable of equalizing batteries (such as a system including multiple Conext XW Pro units and/or Conext XW Pro Solar Charge Controllers), there is no system-wide equalization command for all devices. To equalize with multiple devices, each would have to be enabled individually. Alternatively, equalization can be performed using only the selected device. During the equalization process, one device applies the equalization charge while the other devices continue to operate in synchronized charge mode, typically in float (three-stage charging) or no-float (two-stage charging).

LED

The yellow Equalize LED indicates that the Conext XW Pro is equalizing batteries.

Symbol	LED On	LED Flashing
	The Conext XW Pro has begun equalizing the batteries.	Equalization has been requested but has not begun. The Conext XW Pro must complete a charge cycle before applying the equalization charge.

Using Startup/Shutdown/Standby Modes

Startup/Shutdown control

When the Conext XW Pro is operating, pressing and holding the STARTUP/SHUTDOWN button (see *Figure 10 on page 34*) for five seconds shuts down the unit. To return the unit to its operating state, press the STARTUP/SHUTDOWN button again.

While the Conext XW Pro is turning off, the other inverter information panel buttons stop working. The shutdown process cannot be cancelled. The Conext XW Pro can only be restarted once the display is blank.

Standby mode

In Standby mode, the Conext XW Pro stops charging and inverting. Also in Standby mode, the Conext XW Pro disconnects its internal transfer switches which stops AC to pass through to the AC output. However, the unit remains powered and present on the Xanbus network. Lastly, in Standby mode, Conext XW Pro basic and advanced settings can be changed and put into effect.

To put the Conext XW Pro into Standby mode, press and hold the STARTUP/SHUTDOWN button and the Equalize button simultaneously for about five seconds. The display shows Stb. To return the Conext XW Pro to operating mode, press the STARTUP/SHUTDOWN button momentarily.

Pressing the STARTUP/SHUTDOWN button momentarily while the Conext XW Pro is operating clears active faults and warnings.

Single-unit installations

In a single-unit installation, when the Conext XW Pro is shut down using the STARTUP/SHUTDOWN button, Xanbus network power is off. When Xanbus network power is off, network-connected accessories such as the Automatic Generator Start (Conext AGS) and Conext Gateway could lose power and stop operating. Conext MPPT solar charge controllers continue to operate if Xanbus network power is removed, but they do not continue to communicate with each other.

If the STARTUP/SHUTDOWN button is pressed and held on a Conext XW Pro and a Conext AGS is installed in the system, the unit stops inverting or charging immediately and shuts down completely in 120 seconds. During this time, the display shows OFF. This interval allows the Conext AGS to stop the generator after a cool down period. During the 120 second shutdown time, all network communication is blocked and the unit sends a shutdown command to all other devices in the system. As well, the inverter information panel buttons stop working. The shutdown process cannot be canceled. The Conext XW Pro can only be restarted again once the display is blank.

Multiple-unit installations

If the STARTUP/SHUTDOWN power button is pressed and held on a master Conext XW Pro and a Conext AGS is installed in the system, the unit stops inverting or charging immediately and turns off completely in 120 seconds. During this time, the display shows OFF. This interval allows the Conext AGS to stop the generator after a cool down period. During the 120 second shutdown time, the master unit stops network communication and the slave units issue an external sync fault (F69) or a system configuration fault (F66). As well, the inverter information panel buttons stop working. The shutdown process cannot be cancelled. The Conext XW Pro can only be restarted once the display is blank.

In a multiple-unit installation, when a slave Conext XW Pro is shut down, other Conext XW Pro units continue to supply Xanbus network power and the Conext AGS and Conext Gateway continue to operate.

Monitoring Battery Level

When the Conext XW Pro is inverting, the row of five LEDs indicates the approximate available SOC (State of Charge) of the batteries connected to the system. This capacity reading is based on battery voltage.

The battery LEDs can retrieve information from various sources depending on the devices installed in the system. SOC information is reported from one of the following devices, listed in order of priority:

1. Conext Battery Monitor (If installed)
2. Conext MPPT solar charge controller (When operating)
3. Conext XW Pro

When the Conext XW Pro is reporting, there are five battery states from empty to full. When the available battery state is empty, no LEDs are lit. The battery is considered empty when its depth of discharge exceeds approximately 50 per cent. When the battery capacity is low, the two leftmost LEDs are lit. When the battery is at medium capacity, the four leftmost LEDs are lit. When the battery capacity is full, all five LEDs are lit. When the Conext Battery Monitor or Conext MPPT solar charge controller devices are reporting, the true SOC will be indicated on the battery level LEDs and all LEDs will be utilized.



NOTE: The battery LEDs are not a precise indicator of battery level. They are to be considered a general guideline rather than an exact measurement. For greatest accuracy, install the Conext Battery Monitor (Part # 865-1080-01) or refer to the external BMS readings, if installed.

Figure 11 Battery Level LEDs



Reading the Display Screen

The numeric display screen shows the following information about the operational state of the Conext XW Pro:

- Output power in kilowatts (when the  (kW) LED is lit).
- Battery charger current in Amps (when the  (A) charging LED is lit).
- **Stb** when the Conext XW Pro is in Standby mode.
- **Sch** when the Conext XW Pro is in Search mode.
- **OFF** when the STARTUP/SHUTDOWN button is pressed and held for five seconds. **OFF** is displayed briefly before the unit turns off.
- “—” appears when the Conext XW Pro is in transition between modes, when inverter selection is disabled via the Conext Gateway, or operating in AC passthrough mode.
- **En** appears momentarily when the Conext XW Pro is enabled.
- **dIS** appears momentarily when the Conext XW Pro is disabled.
- 5 minute countdown timer value may appear if there is no other more significant information to display after grid interruption during energy export operation.

Monitoring Operation with the Conext Gateway

The Conext Gateway provides remote configuration and monitoring capability for the Conext XW Pro and all other Xanbus-enabled devices in the network via its browser-based web application. It is the primary and recommended way to monitor operations of all networked devices.

Accessing the Device in the Web Application

Refer to *Logging in to the Conext Gateway Web Application* in the Conext Gateway Owner's Guide to gain access to the web application. If connectivity between system components are working, networked Conext XW Pro units can be accessed by clicking the device icon in the **Dashboard** screen, or its instance under the **Devices** menu.

Status Page

The Conext XW Pro Status page displays real-time operational data specific to the selected Conext XW Pro instance. In Tables 2 and 3 are all possible states that can be shown for Inverter Status and Charger Status.

Figure 12 Status page

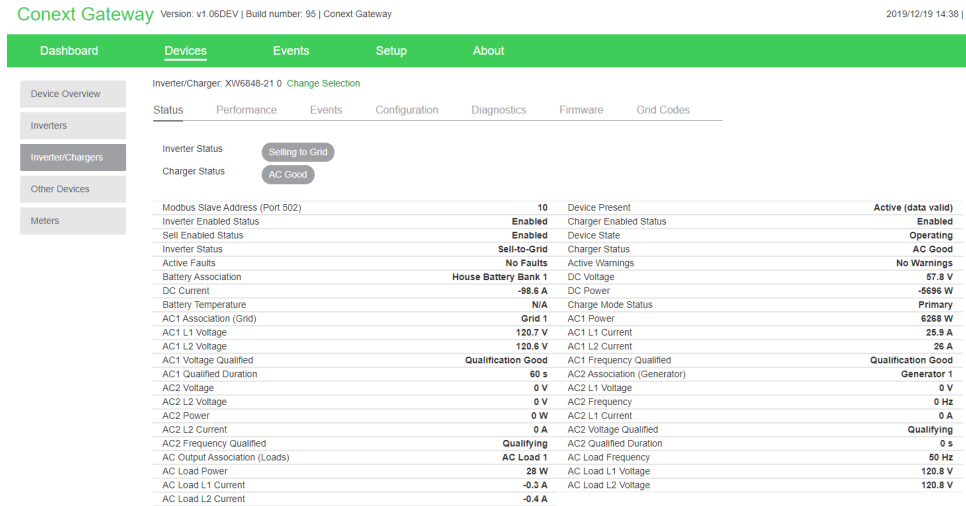

Table 2 Status page inverter states

Status	Displayed when...
Inverting	The Conext XW Pro is supplying power to loads on AC OUT by inverting power from the batteries. AC input from the utility (AC1) or generator (AC2) is absent or out of nominal range.
AC Pass-through	The AC connected to the AC1 or AC2 input is passing directly through the Conext XW Pro to the loads attached to AC Out. The batteries are not being charged or discharged in this state.
APS only	Battery power is being consumed to power the control circuitry only. During grid outages, the inverter is disabled. To enable the inverter for grid-forming, refer to the Controls submenu in the Configuration menu.
Inverter Disabled	Inverter is disabled or the unit has been placed in standby mode using the Conext Gateway web application or the Standby key press (STARTUP/SHUTDOWN and Equalization) on the inverter information panel. To enable the inverter, see <i>"Configuration" on page 51</i> .
Inverter Fault	The Conext XW Pro has an active fault.
Grid Support	There is AC input from the utility grid on AC1, however the priority for the Conext XW Pro is to supply energy converted from external DC sources to the critical loads on AC Out. The Conext XW Pro enters this state only when Grid Support is set to ON and battery voltage is above the Grid Support Voltage or SOC setting.

Status	Displayed when...
Gen Support	<p>There is AC input from the generator on AC2, and the Conext XW Pro is supporting the generator by supplying additional power to the loads attached to AC Out.</p> <p>The Conext XW Pro supports the generator (or other power source connected to the generator [default AC2] input) when the AC load current drawn from the generator exceeds the Generator Support Amps setting for 1 to 2 seconds.</p> <p>The Conext XW Pro uses stored battery energy to load share with the generator until the total AC load current (generator plus Conext XW Pro output) drops by 2 amps plus 10 per cent of the Generator Support Amps setting for 0.5 seconds.</p> <p>For example, if Generator Support Amps is set to 10 amps, the Conext XW Pro starts to support when the load exceeds 10 amps for 2 seconds and stops when it drops more than 3 amps below the Generator Support Amps setting, or 7 amps (2 amps plus 10 per cent of 10 amps = 3 amps).</p> <p>The system can enter this state if the battery voltage is above Low Batt Cut Out +2V and generator support is enabled. Refer to <i>"Configuration" on page 51</i>.</p>
Selling to Grid	<p>The Conext XW Pro is grid-tied and is exporting energy to the utility grid on AC1. Both Grid Support and Sell must be enabled in order to sell power back to the utility. Refer to <i>"Configuration" on page 51</i>. All configurations must comply with local and national electrical codes.</p>
Load Shaving	<p>The Conext XW Pro supports the utility grid when there is AC input on AC1 and the current required to power the loads rises above the Load Shave Amps setting between the Load Shave Start and Load Shave Stop times set on the Grid Support menu. However, AC charging including force charging is disabled during these times. AC charging is enabled when battery voltage falls below [LBCO + 1V], or when battery SOC falls below the SOC LBCO. For an illustration, refer to <i>Figure 18 on page 77</i>.</p> <p>When load shaving, the Conext XW Pro uses stored battery energy to reduce the peak load on the AC1 input by providing the difference between the actual load current and the Load Shave Amps setting. The Conext XW Pro enters this state only when Grid Support is enabled, the load shave time window is valid and the load draw exceeds the Load Shave Amps setting. The battery voltage must also be between Recharge Volts +0.5 V and the Grid Support Voltage setting or Recharge SOC and Grid Support SOC settings respectively if SOC control is enabled. Refer to <i>"Configuration" on page 51</i>.</p>
AC Coupling	<p>If AC Coupling is enabled, the Conext XW Pro is modulating the incoming power from any AC-coupled PV inverters as needed via frequency-shifting.</p>

Table 3 Status page charger states

Header 1	Header 2
Absorption Exit Pending	The Conext XW Pro has completed the absorption stage and is waiting for other Conext XW Pro units in the system to complete absorption. This status can occur only when there is another Conext XW Pro also charging the battery.
Bulk	The Conext XW Pro is bulk charging the batteries from qualified AC input from the utility grid (AC1) or a generator (AC2). AC input is also passed through to the load while bulk charging.
Absorption	The Conext XW Pro is absorption charging the batteries from qualified AC input from the utility grid (AC1) or a generator (AC2). AC input is also passed through to the load while absorption charging.
Equalize	Equalization has been turned on and the Conext XW Pro is equalizing the batteries after completing a full charge cycle.
Float	The Conext XW Pro is float charging the batteries from qualified AC input from the utility grid (AC1) or a generator (AC2). The Conext XW Pro is set for three-stage charging. AC input is also passed through to the load while float charging.
Constant Voltage and Current	Charging state when External BMS is selected for Charge Cycle.
Charger Disabled	Charging functionality is disabled. To enable this, refer to <i>"Configuration"</i> on page 51.
Qualifying AC	The Conext XW Pro is determining if AC input on AC1 or AC2 is within a usable voltage and frequency range. Qualifying AC is also displayed when the Conext XW Pro is awaiting application of AC power or a command to enable invert mode.
Qualifying APS	The Conext XW Pro is undergoing a self-test to ensure the power to the control circuitry (Auxiliary Power Supply) is adequate for use.
AC Good	The unit has qualified the input at AC1 or AC2 as within a usable voltage and frequency range.
APS Good	The unit has qualified the Auxiliary Power Supply.
AC Fault	The unit has encountered a fault. The fault description is displayed in the Status or Events menus along with suggested remedies. To clear the fault, refer to the Controls submenu in the Configuration menu.
Charge	The Conext XW Pro is charging the batteries from qualified AC input from the utility grid (AC1) or a generator (AC2). The charge state is in transition to either bulk, absorption, float, or equalize. AC input is also passed through to the load while charging.
Ground Fault	A ground fault has been detected by the system.

Performance Page

The Performance page provides a more graphical dashboard-type interface of energy and power flow through the system, as well as the ability to plot historical incoming/outgoing energy and to export the data into various file formats.

Figure 13 Performance Page

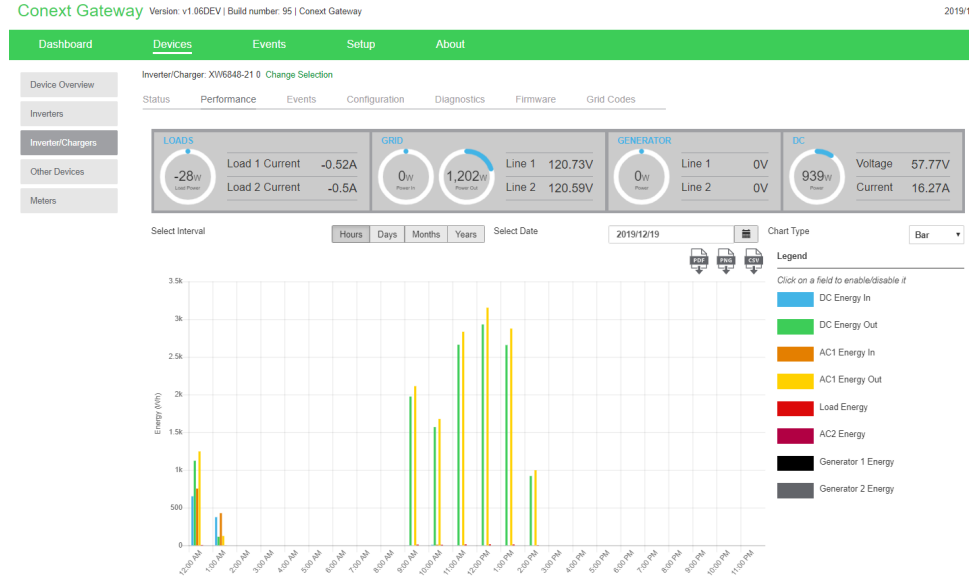

Events Page

The Events page displays all active faults and warnings and maintains a record of all that has occurred in the past until it is cleared. To clear logged Events, refer to the **Configuration** menu for the Conext XW Pro device instance in the Conext Gateway web application, under the **Controls** submenu.

3 External Monitoring Control

What's in This Chapter?

Overview	48
SunSpec Modbus	48
Power Limiting	48
Communications Loss	48
IEEE2030.5	49

Overview

The Conext XW Pro digital communications interface with the Conext Gateway supports commands from external equipment to control power output and operational modes, which allows support for industry-accepted communication standards SunSpec Modbus and IEEE2030.5.

Figure 14 SunSpec Configuration

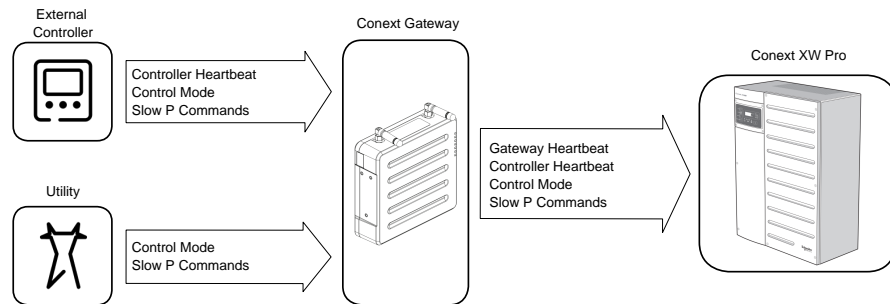

SunSpec Modbus

The Conext XW Pro supports the following data models from the SunSpec Modbus specification via the Conext Gateway.

SunSpec Model Name	Description
Model 1	Equipment Identification
Model 102	Split-Phase Inverter Monitoring
Model 121	Basic Settings
Model 123	Immediate Controls
Model 124	Storage Controls
Model 20001	Inverter Custom Model

Power Limiting

Externally-controlled power limits are applied at the AC transformer at the inverter output prior to connecting with the AC bus. During Selling, Conext XW Pro arbitrates between all sources of power limitation, including externally-controlled limits, by taking the minimum. If the system receives a lower power request than what is currently in effect, the Conext XW Pro will control power flow to the new limit.

Similarly, during Peak Load Shaving, the lower of Load Shave Amps and the externally-controlled limit minus the load power is taken.

Communications Loss

Communications with the SunSpec Controller is continuously monitored. When a communications loss with either the Conext Gateway or the SunSpec Controller is detected, the Conext XW Pro supports the following configurable responses via a

datapoint in Model 20001. This setting cannot be set in the Conext Gateway web application.

Fallback Action	Datapoint Value	Description
Heartbeat Disabled	0 (default)	Commands revert to default until communication is re-established. A warning will not appear.
Do Nothing	1	Continue with the last received set of control parameters. A warning will appear.
Autonomous Operation	2	Commands revert to default until communication is re-established. A warning will appear.
AC Passthrough	3	3 Conext XW Pro transitions to AC Passthrough mode. A warning will appear.

IEEE2030.5

The Conext XW Pro is IEEE2030.5-certified when connected to the Conext Gateway and External Monitoring & Control is done by client-server communication type. This includes California Rule Phase 3 Functions 1, 2, 3 and 8:

Phase 3 Function 1	Monitor Key DER Data <ul style="list-style-type: none"> ■ Reactive power (Vars) ■ Phase voltage ■ Frequency ■ Energy storage state of charge (%) ■ Operational state
Phase 3 Function 2	DER Disconnect and Reconnect Command
Phase 3 Function 3	Limit Maximum Active Power Mode
Phase 3 Function 8	Scheduling Power Values and Modes <ul style="list-style-type: none"> ■ Volt-Var curve control ■ Fixed power factor control ■ Volt-Watt curve control

4 Configuration

What's in This Chapter?

Configuration with the Conext Gateway Web Application	52
Accessing the Web Application	52
Setting the Device Name	53
Setting the Device Number	53
Setting the Time and Date	54
Conext XW Pro Configuration Page	54
Controls Settings	54
Inverter Settings	55
Charger Settings	59
AC Settings	73
Grid Support Settings	75
Generator Support Settings	78
Auxiliary Output Settings	80
Multi-Unit Configuration Menu	83
Associations Settings	85
Advanced Features	87
Advanced Device Settings	89
Battery Management System Settings	89
Device Instance Settings	91
Modbus Settings	92
Prioritizing and Managing Energy Sources with Advanced Features	93
Grid Support	93
Charger Block	96
Peak Load Shaving (PLS)	96
Managing Firmware	98
Managing Compliance Regions	99
Resetting the Conext XW Pro to Default Settings	100

Configuration with the Conext Gateway Web Application

The Conext XW Pro is configured primarily using the Conext Gateway web application interface. The Conext Gateway provides access to settings relating to AC input and output, battery charging, compliance regions, and grid-tie operation. Refer to the *Conext Gateway Owner's Guide* more details.

Accessing the Web Application

Refer to "Logging in to the Conext Gateway Web Application" in the *Conext Gateway Owner's Guide* to gain access to the web application. If connectivity between system components are working, a Conext XW Pro can be accessed by clicking the device figure in the **Dashboard** screen, or its instance under the **Devices** menu. Device configuration is available only to the Administrator access level.

NOTICE

EQUIPMENT DAMAGE

Ensure you put the Conext XW Pro in Standby mode prior to changing basic or advanced settings. Return to Operating mode for the settings to take effect.

Any configuration (change in settings) made when the Conext XW Pro is in Operating mode will not be saved unless the Conext XW Pro is put in Standby mode and then back to Operating mode.

Failure to follow these instructions can result in equipment damage.

Setting the Device Name

The **Dev Name** setting allows you to customize the name of the Conext XW Pro as it is displayed on other screens and menus.

The characters available are:

- A to Z
- a to z
- 0 to 9
- space

NOTE: Increasing the number of characters in a device name may cause other text on the same line to run off the edge of the screen. Device names should be limited to 10 characters or less.

The Conext XW Pro device name can be set at the device's **Configuration** page in the Conext Gateway web application under the **Device Instance** menu.

NOTE: It is also possible to change the device name using the Conext Configuration Tool. Please refer to the Owner's Guides for the Conext Configuration Tool for further information.

Setting the Device Number

When several devices of the same type are installed in the Xanbus network, setting the device number is required to give a Xanbus-enabled device a unique identity. When each identical device has a unique number, the Conext Gateway web application can correctly identify and display status information for each device. A device number consists of two digits ranging from 0 (default) to 247.

If only one of each type of device is installed in the networked power system, a device number is not needed. However, setting the device number to a value other than 0 is recommended in case you need to use the **Restore Defaults** command. This command resets the device number to 0. After performing the command, checking that the device number has returned to 0 indicates that the command was successfully completed. The Device Number can be set at the device's **Configuration** page in the Conext Gateway web application under **Device Instance**.

Setting the Time and Date

Conext XW Pro advanced features such as peak load shaving, charger block, and time-stamped events (faults, warnings, and logged historical data) require that the system be set to the correct time. The Conext Gateway has an internal clock that controls the time for the Xanbus-enabled devices in the system. You can set the time, time format, and date on the **clock** menu. The **Time Setup** menu is accessible under **Configuration** in the **Conext Gateway Setup Screen** where the time zone, time, and date are adjustable.

For more information, see “Changing the Time” in the *Conext Gateway Owner's Guide*.

Conext XW Pro Configuration Page

The Conext XW Pro device's configurable operating parameters can be found on the **Configuration** page within the Conext Gateway web application in the device instance's own menus. This document will also cover the additional parameters available in the Advanced view.

Controls Settings

The **Controls Settings** menu provides the high-level controls that are expected to be used often.

Table 4 Controls Settings Menu

Item	Description
Operating Mode	Places the Conext XW Pro into Standby or Operating mode.
Reset	Allows the user to either do a software reset or revert all configuration parameters to factory defaults.
Clear	Allows the user to clear active or logged faults and warnings, and other logged statistics
Inverter Enable/Disable	Enable or disable grid-forming functionality

<p>Grid Support Sell Enable/Disable</p>	<p>Enables or disables grid-interactive Conext XW Pro features, such as grid support and grid sell mode. Unless an external BMS is utilized and Charge Cycle is set accordingly, to allow grid support to function after battery charging has completed, it is recommended to set the Charge Cycle to 2- Stage. The MPPT controllers must still be set to 3-stage. When using load shave, turning ON Sell and setting Maximum Sell Amps to 0.0 is a way to make the net power flow to the grid zero. If sell is not enabled, there will be a net purchase of as much as 2.0 - 3.0 kWh per day due to the current control loop not allowing any outgoing current. If you wish to further reduce grid draw using this function, enable sell mode even if you do not wish to export power and set Maximum Sell Amps to a value of 0.</p>
<p>Charger Enable/Disable</p>	<p>Enable or disable the charger.</p>
<p>Force Charger State</p>	<p>Manually changes the charge stage to either bulk or float (when 3- Stage cycle is selected), bulk or no float (when 2-Stage cycle is selected), or Constant Voltage and Current. (when Lithium Ion is selected)</p> <p>This command has no effect if load shaving is enabled. For more information, see "Load Shaving" in <i>Table 2 on page 42</i>.</p>
<p>Manual Aux</p>	<p>Sets the state of the auxiliary output. ManualOn or ManualOff allow manual control of the auxiliary output. When set to Automatic, a trigger source can then be selected.</p>

For default settings, see "*Controls Settings Menu*" on page 184.

Inverter Settings

The **Inverter Settings** menu contains settings that control when the Conext XW Pro starts and stops producing AC output.

Table 5 Inverter Settings Menu

Item	Description
<p>Low Battery Cut Out</p>	<p>Low Battery Cut Out (LBCO) controls when the inverter stops producing AC output due to a low battery voltage condition. The inverter will stop producing AC output only after this level has been reached for the period of time set by the Low Battery Cut Out Delay. This setting is not temperature compensated.</p>

Item	Description
<p>Low Battery Cut Out Delay</p>	<p>Low Battery Cut Out Delay controls how long the inverter is allowed to operate at or below the Low Battery Cut Out level before turning off due to a low battery voltage condition. The inverter will stop producing AC output only after the Low Battery Cut Out level has been reached for this uninterrupted period of time.</p> <p>Once the inverter has shut off, the battery voltage must rise the amount of volts set in Low Battery Cut Out Hysteresis above the Low Battery Cut Out setting for inverter operation to resume.</p>
<p>Low Battery Cut Out Hysteresis</p>	<p>The voltage increment on top the Low Battery Cut Out parameter above which the battery voltage must be for inverter operation to be allowed to resume.</p>
<p>High Battery Cut Out</p>	<p>High Battery Cut Out sets the maximum battery voltage at which the inverter will operate. If the battery voltage exceeds this limit for more than 1 minute, the Conext XW Pro displays a fault message (F49) and shuts down. The inverter will not support AC loads when in this condition. If a qualified AC source is present, the unit passes AC through to the loads. The inverter automatically restarts when the voltage drops to 6 volts below the High Battery Cut Out setting. If battery voltage continues to rise after shutdown, an external charger may still be charging the batteries. The Conext XW Pro cannot control how external chargers operate.</p>
<p>High Battery Cut Out Delay</p>	<p>High Battery Cut Out Delay controls how long the inverter is allowed to operate at or above the High Battery Cut Out level before turning off due to a high battery voltage condition. The inverter will stop producing AC output only after the High Battery Cut Out level has been reached for this uninterrupted period of time.</p>
<p>Search Mode</p>	<p>Enable or disable Search Mode.</p>
<p>Maximum Search Watts</p>	<p>Maximum Search Watts sets search sensitivity for the Conext XW Pro when search mode is enabled. When a load larger than this setting is present on AC OUT, the inverter starts producing AC output from battery power. Enabling search mode from the same menu can minimize power draw from the battery during periods of low demand from loads. Note that energy-efficient light bulbs may not provide enough power to wake the inverter from Search mode.</p>

Item	Description
Search Delay	Search Delay sets the time between search pulses. When searching for loads, the Conext XW Pro sends out search pulses on AC OUT to determine the presence of a load above Search Watts. Conext XW Pro power draw while in search mode decreases when Search Delay is increased, but the Conext XW Pro response time to active loads is slower.
High SOC Cut Out	The upper limit of where Conext XW Pro will charge its connected battery pack when State of Charge Control is enabled. When the battery pack has been charged at or above this level after a delay set in High SOC Cut Out Delay, charging will terminate.
High SOC Cut Out Delay	The time duration for which the battery State of Charge must be at or above High SOC Cut Out before terminating.
Low Battery Cut Out SOC	The lower limit of where Conext XW Pro will discharge its connected battery pack when State of Charge Control is enabled. When the battery pack has been discharge at or below this level after a delay set in Low Battery Cut Out SOC Delay, the discharging activity will terminate.
Low Battery Cut Out SOC Delay	The time duration for which the battery State of Charge must be at or below Low Battery Cut Out SOC before terminating the discharge.
Action on Communication Loss	Configures the action taken during a general communications loss with the Conext Gateway.

For default settings, see "Inverter Settings Menu" on page 184.

Using the Low Battery Cut Out and LBCO Delay Settings

<p> WARNING</p> <p>ADVANCED CONFIGURATION HAZARD</p> <ul style="list-style-type: none"> ■ Advanced menu settings should be used by qualified personnel only. ■ Three phase operation should be configured by qualified personnel only. ■ Consult with the local utility before enabling Conext XW Pro sell mode or grid support functions. ■ Do not change these settings unless you are under the supervision and direction of qualified personnel. ■ Connect the Conext Gateway and the network router connected to the Conext Gateway to an assured power source during configuration. <p>Failure to follow these instructions can result in death, serious injury, or equipment damage.</p>
--

The **Low Battery Cut Out** setting is the lowest battery voltage or SOC level acceptable for use by the inverter. When the batteries discharge to the **Low Battery Cut Out** setting, and are held at or below this level for the **LBCO Delay** time, the inverter output shuts down and connects any available AC source (AC1 or AC2) to the charger to bring the battery level back above the **Low Battery Cut Out** setting. After shutdown, the inverter does not support loads on AC OUT, and AC loads must be powered by either a generator (AC2) or grid power (AC1). If the battery voltage or SOC stays below the LBCO threshold for more than 24 hours, the Conext XW Pro shuts down.

If using the Conext Automatic Generator Start system, it is recommended to set the AGS voltage or low SOC trigger setting higher than the Conext XW Pro **Low Battery Cut Out** voltage or SOC level.

Although not recommended, if using the Conext Automatic Generator Start system with the start trigger set to the same voltage as the LBCO voltage, do not set the **LBCO Delay** for less than the amount of time it takes the generator to start and connect.

Otherwise – in both of the scenarios above – inverter output turns off before the generator automatically starts, causing the battery voltage to recover slightly. This may then stop the AGS from starting the generator or result in the Conext XW Pro cycling on and off multiple times before the generator automatically starts.

Using Search Mode

Why use Search mode?

Search mode allows the inverter to selectively power only items that draw more than a certain amount of power, which can result in energy savings. The Conext XW Pro has a no-load power draw of about 28 watts. Enabling search mode reduces this power draw to less than 8 watts. Search mode operates differently in single-unit and multi-unit installations.

Single units

When a single Conext XW Pro has search mode enabled, the inverter sends electrical search pulses through its AC output. These search pulses look for connected AC loads. The delay between search pulses is set using the **Search Delay** setting. After a load larger than the **Search Watts** setting is detected, the inverter starts producing AC output.

Multiple units

It is not recommended to use search mode for Conext XW Pro inverters in a multi-unit configuration.

When to set up Search mode

The search mode feature is only valuable if the inverter can spend a fair amount of time “sleeping” each day. Therefore, if search mode is to be used it must be adjusted properly. The initial adjustment should be made so that the Conext XW Pro comes on only when needed.

Certain types of loads can cause search mode to work improperly. These types of loads are described in "*Problem Loads*" on page 103. If these kinds of loads are in the system, follow the suggestions given to resolve the problem.

If the problem loads cannot be resolved, there are two workaround solutions:

Disable search mode from the main Conext XW Pro Setup menu, causing the inverter to remain at full output voltage.

Use a search friendly companion load whose only purpose is to be switched on to wake up the inverter to power the load that is unable to bring the inverter out of search mode.

NOTE: Search mode, by function, cannot work with clocks and timers or devices that need power 24 hours a day. Examples of devices with timers include video recorders, coffee makers with brew timers, refrigerators, and freezers with defrost timers.

Examples of devices that need power 24 hours a day include telephone answering machines, alarm systems, motion detection lights, and some thermostats.

When the inverter is searching the output for loads, lights that have a wattage lower than this setting may flash momentarily.

Charger Settings

WARNING

ADVANCED CONFIGURATION HAZARD

- Advanced menu settings should be used by qualified personnel only.
- Three phase operation should be configured by qualified personnel only.
- Consult with the local utility before enabling Conext XW Pro sell mode or grid support functions.
- Do not change these settings unless you are under the supervision and direction of qualified personnel.
- Connect the Conext Gateway and the network router connected to the Conext Gateway to an assured power source during configuration.

Failure to follow these instructions can result in death, serious injury, or equipment damage.

⚠ WARNING

BATTERY TYPE AND SETUP HAZARDS

- Incorrect battery configurations or settings for battery types can lead to dangerously high battery temperature, fire and explosion. To avoid damaging your batteries during charging or equalization, and to minimize the risk of fire or explosion consult battery manufacturer's documentation before setting battery parameters and follow the battery manufacturer's recommended settings.
- Always use and connect the Battery Temperature Sensor (BTS), unless an external BMS fulfilling this function is installed.
- Always verify that the configured battery type matches the battery type being used.
- Custom battery settings should be configured by qualified personnel only.
- When using Lithium-Ion batteries, ensure that the battery pack being used includes a certified Battery Management System (BMS) with safety controls. Refer to Li-Ion Battery Technical Note (document number 990-6359) for additional information.

Failure to follow these instructions can result in death, serious injury, or equipment damage.

The **Charger Settings** menu provides options for configuring the Conext XW Pro to operate from your battery bank.

Table 6 Charger Settings Menu

Item	Description
Batt Type	Sets the system battery chemistry and type: Flooded (default), AGM , Gel , Lithium Ion , and Custom .
Battery Bank Capacity	Selects the system battery capacity in Ah (amp hours). Setting the Battery Bank Capacity to 0 resets the charging current to its default values. Zero Ah battery capacity implies there is no absorption exit current criteria and absorption only exits when the absorption timer (default 3 hours, range 1 minute-8 hours) expires.
Maximum Charge Rate	<p>Sets the percentage of the maximum DC output current that is available to the charger. The maximum DC output current for different models is:</p> <ul style="list-style-type: none"> ■ XW Pro 6848 NA—140 A <p>If multiple Conext XW Pros are charging the same battery bank, set each inverter's Maximum Charge Rate to 1/n of the desired charge rate (where n is the number of inverter/chargers).</p> <p>Always refer to the battery manufacturer's specifications before setting the Maximum Charge Rate. Do not set the Maximum Charge Rate above these specifications.</p>

Item	Description
Maximum Bulk Charge Current	Adjustable only when the Batt Type is set to Li-Ion. Sets the bulk current for a lithium ion battery type. This configures the current limit when the Conext XW Pro is in Bulk Charge Mode. However, between the maximum charge current (Maximum Charge Rate × maximum DC output current) and the value set here, the Conext XW Pro charger will charge at the lesser of these two values.
Maximum Absorption Charge Current	Adjustable only when the Batt Type is set to Li-Ion. Sets the absorb current for a lithium ion battery type. This configures the current limit when the Conext XW Pro is in Absorption Charge Mode. However, between the maximum charge current (Maximum Charge Rate × maximum DC output current) and the value set here, the Conext XW Pro charger will charge at the lesser of these two values.
Maximum Float Charge Current	Adjustable only when the Batt Type is set to Li-Ion. Sets the float current for a lithium ion battery type. This configures the current limit when the Conext XW Pro is in Float Charge Mode. However, between the maximum charge current (Maximum Charge Rate × maximum DC output current) and the value set here, the Conext XW Pro charger will charge at the lesser of these two values.
Charge Cycle	Sets the charging method: 3-Stage (bulk, absorption, float), 2-Stage (bulk, absorption, no float), or External BMS .
Default Battery Temperature	Selects the battery temperature charging compensation if a battery temperature sensor is not installed. In the absence of a battery temperature sensor, the charger uses one of three settings: Cool (5 °C/41 °F), Warm (25 °C/77 °F), or Hot (40 °C/104 °F).
Recharge Voltage	When charger is set for 2-stage operation, sets the battery voltage level at which a new charge cycle begins. Recharge Voltage is automatically temperature compensated to be consistent with the charge voltage (also temperature compensated).
Absorption Time	Sets the maximum time spent in the absorption stage, before transitioning to float or no float.
Charge Block Start	Sets the time to halt charging on AC1 (Grid). The AC2 (Gen) port is unaffected by the Conext XW Pro block settings. The charger block start and stop settings allow you to select when the charger stops charging on AC1. To disable the charger block function, set Charge Block Start and Charge Block Stop to the same time.
Charge Block Stop	Sets the time that charging on AC1 can resume. At the Charge Block Stop time, charging on AC1 is enabled again.
Equalize Support	Enables or disables the ability to enter an equalization cycle. Refer to the battery manufacturer's specifications to determine whether equalization is recommended.

Item	Description
Equalize Now	Set to Enable to force an equalization process.
Equalize Voltage Set Point	Selects the equalization voltage for a Custom battery type. Consult your battery manufacturer for equalization voltage setting.
Bulk/Boost Voltage Set Point	Sets the bulk voltage for a custom battery type. When set above the absorption voltage set point, this value becomes the reference for boost voltage.
Absorption Voltage Set Point	Sets the absorption voltage for a custom battery type.
Float Voltage Set Point	Sets the float voltage for a custom battery type.
Battery Temperature Coefficient	<p>Battery temperature compensation for a custom battery type. This setting is the reference that the BTS uses to adjust the charging voltage when the temperature is above or below 25 °C (77 °F).</p> <p>The following voltage thresholds are not temperature compensated:</p> <ul style="list-style-type: none"> ■ Grid Support entry voltage ■ Grid Support exit voltage ■ Low Battery Cut-Out trigger voltage ■ Low Battery Cut-Out condition clear voltage <p>The following battery voltage set points are temperature compensated:</p> <ul style="list-style-type: none"> ■ Float exit voltage ■ Bulk exit voltage ■ Float and Gassing voltages used in Constant Voltage exit criteria ■ Recharge Volts ■ Charge Control target voltage
Max Discharge Current	Each Lithium Ion battery has an internal contactor and over load protection which is based on maximum current. If exceeded, the contactor may open, resulting in complete isolation of the battery pack, thus removing power to the Conext XW Pro. In this case the Xanbus communication as well as devices powered from the Conext XW Pro could become unusable. When the Conext XW Pro current draw exceeds the set value for a period defined in Max Discharge Time Interval , the Conext XW Pro disables INV output.
Max Discharge Time Interval	Allows the Conext XW Pro current in Invert mode to exceed the Max Discharge Current limit for inrush periods to startup loads such as pumps/motors. When the timer expires, the Conext XW Pro disables INV output.

Item	Description
Bulk Termination Voltage	Sets the voltage at or above which the Conext XW Pro begins the timer to exit the bulk charging stage.
Bulk Termination Time	Sets the time delay to exit the bulk charging stage once the bulk termination voltage has been reached or exceeded.
Absorption Period Timeout	Sets the time period that the Conext XW Pro will remain in the absorption charge stage
Recharge SOC	Sets the SOC at or under which the Conext XW Pro will terminate any discharging activity and begin to charge the battery if a qualified AC source is available. Takes effect only when State of Charge Control is enabled..
Recharge SOC Delay	Sets the time delay after which the Conext XW Pro will begin to charge the battery when SOC falls below the Recharge SOC , if a qualified AC source is available.
EPC Max Charge Power	Maximum charge power controllable via external interface.

For default settings, see *"Charger Settings Menu" on page 185.*

Battery Charger Functions

When AC power is available, the Conext XW Pro can operate as a battery charger. Different battery types and chemistries require different charging voltage levels. Not charging batteries at the required levels can shorten battery life or damage the batteries. The Conext XW Pro is configured at the factory to work with the battery types recommended for inverter applications. If the default settings do not work for your specific installation, you can adjust the charge stage settings (as recommended by the battery manufacturer) by setting the **Battery Type** to Custom.

NOTE: This information is provided for guidance only. Variations in battery chemistry and site-specific environmental considerations mean that you should consult your system designer or battery manufacturer for specific recommendations for appropriate battery voltage and current settings.

Battery Monitoring

The following table illustrates how to configure the Conext XW Pro for the available battery monitoring methods.

	No External Battery Monitoring	Conext Battery Monitor	External Battery Management System (BMS)
Battery Type	Any ¹	Any	Li-ion
Charge Cycle	2-stage or 3-stage	2-stage or 3-stage	External BMS
State of Charge Control	Disabled	Enabled	Enabled

Without any external battery monitoring, Conext XW Pro operational state transitions, charge control, and AC coupling functions are completely based upon the measured battery voltage.

The Conext Battery Monitor is a dedicated piece of hardware that determines the hours of battery-based runtime and battery bank state of charge, and shares this information with other devices on the same Xanbus network. With the Battery Monitor installed, enabling State of Charge Control is recommended. State transitions will be based on the reported State of Charge and will utilize the corresponding SOC threshold settings. Charge control will still be based on battery voltage.

Typically installed with lithium-ion battery packs, external battery monitoring systems take on a more extensive role in monitoring the battery and ensuring it does not operate outside of its safe parameters. When Charge Cycle is set to External BMS, charge control on the Conext XW Pro will be based on the SOC readings from the BMS and will utilize the corresponding SOC threshold settings.

Multi-Unit Charger Settings

NOTICE

DAMAGE FROM HAVING DIFFERENT CHARGER SETTINGS

- Make sure that all Conext XW Pro units in the multi-unit setup have the same Charger Settings. For example, if one unit has a Battery Type of Flooded, all Conext XW Pro units **must have** the same Battery Type. To copy the settings to one unit from another, see *Configuration with the Conext Gateway Web Application on page 52*.
- Make sure that all Xanbus devices in the same network, such as connected MPPT solar charge controllers and the Battery Monitor, have the same Charger settings. Refer to each device's owner's guide for information on how to change the charger settings.

Failure to follow these instructions can result in battery damage.

NOTE: Make sure that every Conext XW Pro unit in the multi-unit configuration is set to **Charger = Enabled** under the **Controls** menu for each inverter.

¹ When using Lithium Ion, the flat voltage profile introduces difficulty in precisely monitoring state of charge. A BMS or Conext Battery Monitor is highly recommended in these applications.

Multi-Stage Charging Process

The charging cycle is a multi-stage process. Whenever qualified AC power is present at the AC1 or AC2 input, power runs through to the connected load and begins charging the batteries in parallel.

Figure 15 Three-Stage Battery Charging Cycle

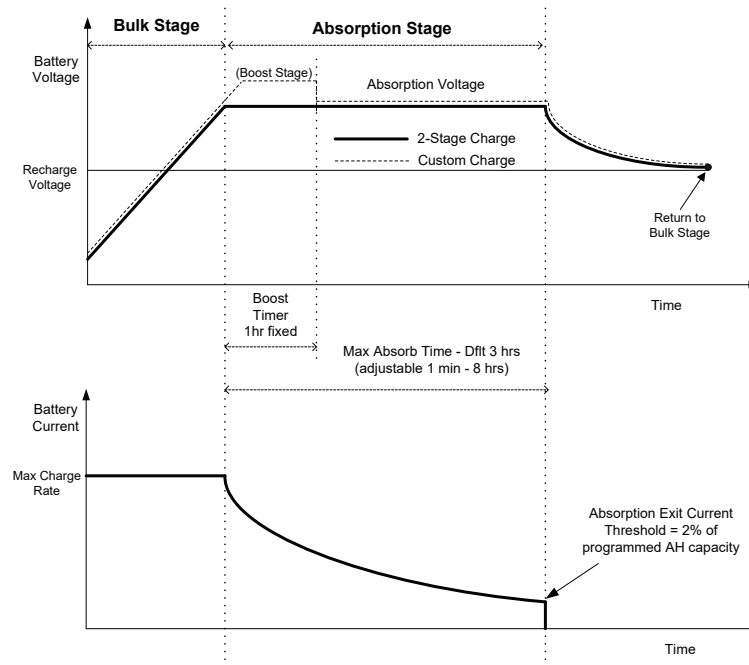

NOTES:

- When the charge cycle is interrupted, the charger will restart charging at the beginning of the multi-stage algorithm.
- Exit Current Threshold can be effectively disabled by programming the amp-hour capacity to 0. In this case, absorption will only exit once the Max Absorption timer expires.
- Charge current during equalize state (optional state not shown here) is normally limited to 10% of the programmed amp-hour capacity setting. If this setting is programmed to 0 Ah, the charge current during equalize is instead limited to whatever is programmed for the maximum current limit of the unit (the default current limit in equalize mode is 60 A).
- Synchronized charge states are active when more than one charging device (Conext XW Pro or Conext MPPT solar charge controller) is connected in the system via the Xanbus network.
- The first Conext XW Pro or Conext MPPT solar charge controller to enter bulk, causes the other chargers to enter bulk.
- The first Conext XW Pro to enter absorption causes the other chargers to enter absorption.

- The last Conext XW Pro ready to exit absorption triggers the rest to exit absorption and exit charge. The Conext XW Pro will not wait for any connected Conext MPPT solar charge controllers to transition to absorption or float.

Bulk Stage

Bulk charge is the first stage in the charging process and provides the batteries with a controlled, constant current. Once the battery voltage rises to the **Bulk Termination Voltage**, the charger switches to the absorption stage.

Absorption Stage

During the absorption stage, the Conext XW Pro begins operating in constant voltage mode and the DC charge current falls gradually as energy is returned to the battery. For the first 60 minutes of the absorption stage, the Conext XW Pro regulates the battery voltage at the **Bulk/Boost Voltage Set Point** setting. The voltage limit used for the remaining time in this stage is the **Absorption Voltage Set Point** setting. By default, the bulk and absorption voltage settings are the same for each battery type. The voltage limit settings for bulk and absorption can be adjusted independently if the battery type is set to **Custom**. The Conext XW Pro transitions to the float stage if either one of the following two conditions are met:

The charge current allowed by the batteries falls below the exit current threshold, which is equal to 2% of the programmed battery capacity (for a 500 Ah battery bank, this would be 10 A), for three minutes.

The Conext XW Pro has been in absorption for the programmed maximum absorption time limit. The default is 3 hours, but the time limit is programmable from 1 minute to 8 hours. The timer begins when the battery voltage is above the **Bulk Termination Voltage** for three minutes.

NOTE: If there are DC loads on the batteries, the charger's current may not decrease to a level to transition to the next stage of charging. In this case, the charger stays in absorption until the **Absorption Time** setting is reached.

To avoid having the charger remain in absorption for too long, adjust **Absorption Time** on the **Charger Settings** menu. The timer begins at the start of the absorption stage and terminates absorption charging if the charge current does not decrease to below 2 per cent of the battery capacity before the **Absorption Time** setting expires. The **Absorption Time** setting may be increased if the charge cycle continually runs the complete **Absorption Time** in the absence of DC loads. This is an indication of too large a battery bank for the selected **Absorption Time** setting.

Boost Charging

- Boost charging allows for better utilization of flooded lead acid batteries under moderate cycling in off-grid or grid support applications. Boost charging encourages a short duration charging voltage—above the gassing voltage—at the beginning of the absorption charge state. Testing has shown that boost charging improves battery performance by providing a regular mixing of the liquid electrolyte. Boost charging specifically discourages capacity robbing acid stratification and plate sulfation.
- Boost mode charging can be enabled by selecting the Custom battery type and by setting the **Bulk/Boost Voltage Set Point** higher than the absorption voltage. The multi-stage charge algorithm then attempts to use the higher voltage for the first hour of the absorption stage, unless it is interrupted by the max absorption timer or exit current threshold.
- Boost charging encourages gassing of flooded lead acid batteries.
- Boost charging is NOT recommended for AGM, GEL or any other electrolyte-limited and/or valve-regulated sealed battery application.
- Boost charging may result in higher than normal water consumption. However, the benefits of boost charging are likely to be greater than the extra watering effort. Check battery water levels at least once per month.
- Boost charging has maximum benefit when used on batteries that experience moderate cycling. An unoccupied cottage, for example, where batteries are full the majority of the time may not benefit from boost charging, especially if battery watering is difficult.
- For equalize charging, a custom Boost charge profile can be configured if the equalize method is not periodically used. Boost charging occurs in the first hour of the absorption stage. It allows for a higher constant voltage than absorption voltage to encourage a “mini equalize” each time the battery is charged.
- The boost voltage is defined by the **Bulk/Boost Voltage Set Point** setting. The Conext system will still allow manual equalize charging when the boost absorption voltage is implemented. This is for advanced users only who pay strict attention to battery maintenance and have an appropriately vented and protected battery installation. Consult your battery manufacturer for appropriate voltages.

Float Stage

Float charge maintains the batteries slightly above the self discharge voltage of the batteries. The charge current in float is the current necessary to maintain the batteries at the **Float Voltage** setting, limited only by the inverter's capability or other settings that limit the inverter's maximum charge rate. Float charging reduces battery gassing, minimizes watering requirements (for flooded batteries), and helps the batteries remain in a constant state of readiness. When three-stage charging is selected, the charger automatically switches to the float stage after the batteries have received a bulk and absorption charge. The batteries are maintained at the default float voltage level for the selected battery type or the voltage selected under **Float Voltage Set Point** on the **Charger Settings** menu.

NOTE: The battery voltage can increase above the float voltage when using an external charging device such as charge controllers attached to PV arrays, wind turbines, and micro-hydro generators. Be sure to include appropriate charge management equipment with all external DC sources.

Two-Stage

Two-stage (or no float) mode differs from an ordinary three-stage charge mode in that it does not continuously maintain the battery at float voltage. Instead, the Conext XW Pro begins charging the battery in bulk mode whenever the battery voltage drops below the recharge level. While the battery voltage is above the recharge level the inverter's AC transfer switch continues to pass through power from the utility grid to the loads, but does not actively charge the batteries.

Two-stage mode increases efficiency of utility connected systems by reducing the amount of power consumed by the inverter and batteries compared to when the battery is continuously maintained at **Float Voltage**. This feature can extend the life of many batteries.

Unless an external BMS is installed and **Charge Cycle** is set accordingly, to allow grid support and sell mode to function after battery charging has completed, it is recommended to set **Charge Cycle** to **2-stage**.

NOTE: If the AC input stops or drops below the lower VAC limit (as set in **AC Settings**), the complete multi-stage charge cycle (bulk, absorption, float/no float) restarts once the source AC recovers to within the acceptable range. If the batteries are already nearly full, the charge cycle will take little time to complete.

Figure 16 Two-Stage Charging Cycle

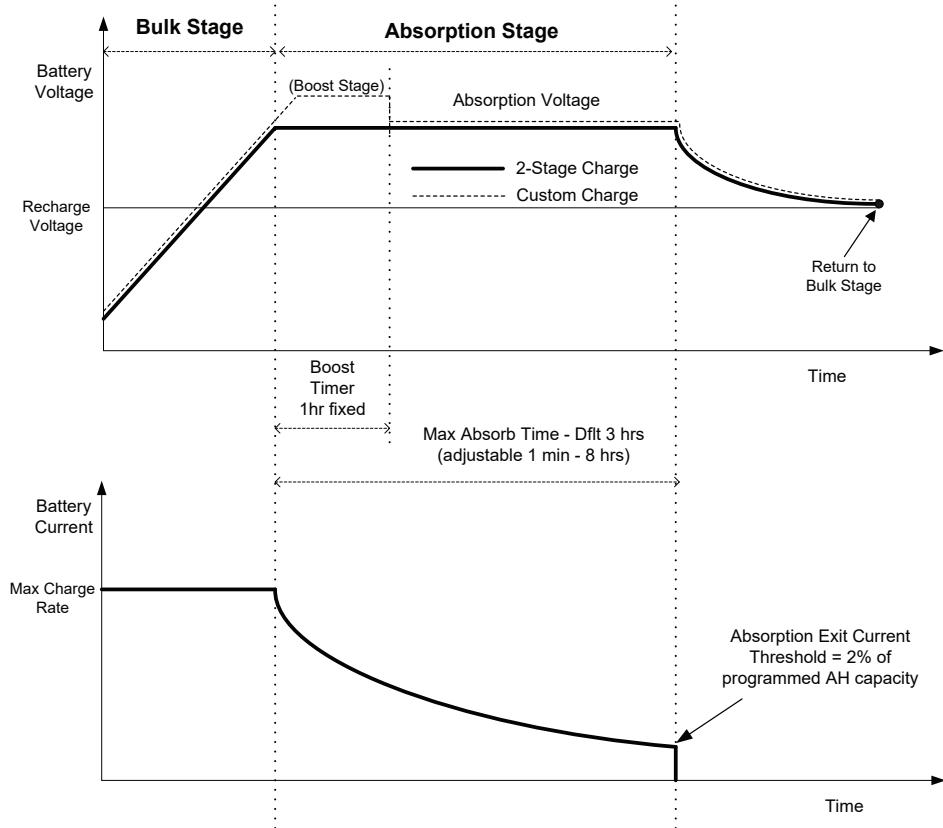

When the charge cycle is interrupted, the charger will restart charging at the beginning of the multi-stage algorithm.

Exit Current Threshold can be effectively disabled by programming the amp-hour capacity to 0. In this case, absorption will only exit once the **Absorption Time** timer expires.

Charge current during equalize state (optional state not shown in graph) is normally limited to 10% of the programmed amp-hour capacity setting. If this setting is programmed to 0 Ah, the charge current during equalize is limited to whatever is programmed for the max current limit of the unit (the default current limit in equalize mode is 60 A).

Synchronized charge states are active when more than one charging device (Conext XW Pro or Conext MPPT solar charge controller) is connected in the system via the Xanbus network.

The first unit (Conext XW Pro or Conext MPPT solar charge controller) to enter bulk, causes the other chargers to enter bulk.

The first Conext XW Pro to enter absorption causes the others to enter absorption.

The last Conext XW Pro ready to exit absorption triggers the others to exit absorption and exit charge. The Conext XW Pro will not wait for any connected Conext MPPT solar charge controllers to transition to absorption or float.

Equalize Charging

Many lead acid battery manufacturers recommend periodic equalize charging to counter cell charge imbalance and capacity robbing sulphation. Equalizing helps to improve battery performance and lifespan by encouraging more of the battery material to become active.

Battery equalization is a controlled overcharging method that reduces sulphation and mixes up stratified electrolyte and reactivates unused areas of the plate material. Periodic equalizing can help to regularly restore flooded lead acid batteries to a healthy state of charge.

Consult the battery manufacturer's recommendation for equalize charging settings. Sealed lead acid, gel, AGM, and lithium ion batteries should not be equalized unless recommended by the battery manufacturer. Consult the battery manufacturer for optimal charging procedures when using sealed batteries.

When **Equalize** mode is enabled, the battery is charged from bulk to absorption, and then to the equalize phase. The Conext XW Pro will transition from the absorption phase to equalize if:

- The DC charge current is below 2% of the configured battery capacity (for example, 8.8 A for 440 Ah).
- The absorption time is exceeded (for example, 180 minutes).

After absorption, the maximum charge DC current is set to 10% of battery capacity (for example, 44 A for 440 Ah). This constant current charge will continue until the voltage has increased to the equalize voltage at which point the battery will be regulated at the temperature compensated equalize voltage.

If the battery capacity is set to zero, the equalize charge current is fixed at maximum 44 A (Ah=0 effectively disables the exit current criteria for the absorption charge stage, making the absorption stage defined by time only).

Equalization duration is fixed at one hour.

NOTE: The graphs below apply only to flooded battery types.

Figure 17 Equalize Charging Grid-tie Sell Mode

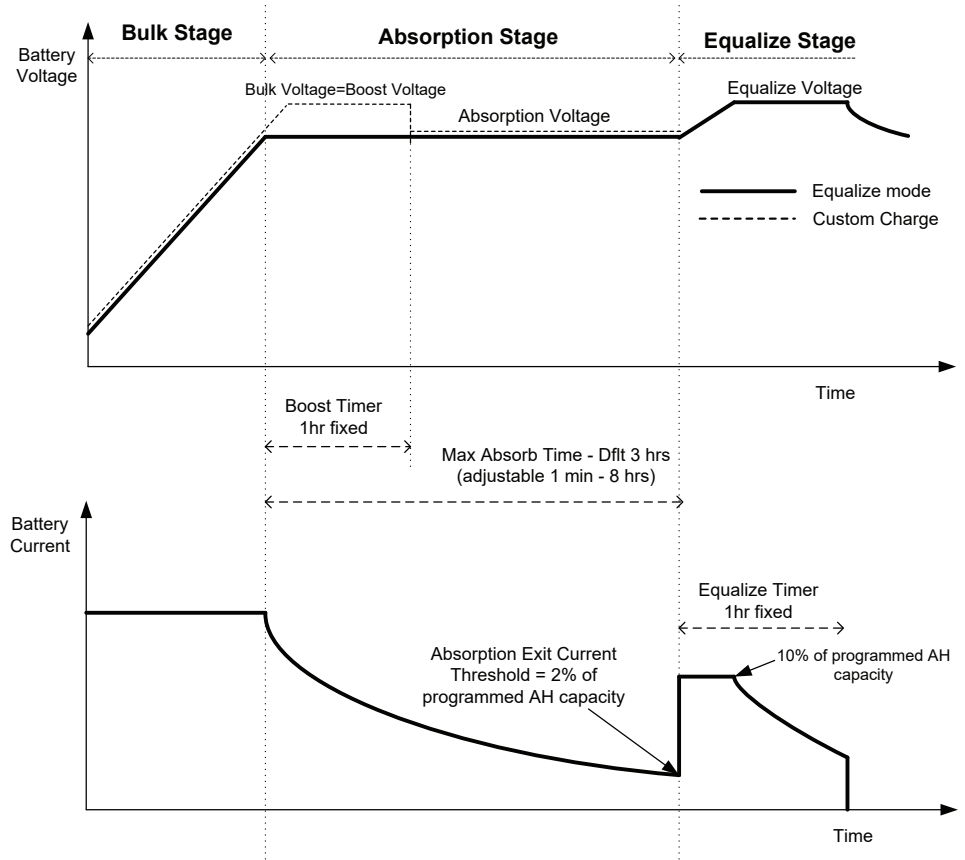

Equalization Procedure

To start equalizing the batteries, do one of the following:

1. On the **Charger Settings** menu, toggle the **Equalize Now** toggle switch to **Enabled**.
2. Press the **Equalize** button on the inverter information panel for five seconds.

If the Conext XW Pro will not perform the equalization, see Warning W96 “Cannot Equalize” in *Table 23 on page 110*.

 WARNING
<p>EQUALIZATION HAZARD</p> <p>Only flooded lead acid batteries should be equalize charged. Hydrogen and oxygen gases are produced when batteries are equalized and can potentially cause an explosion if ignited. Corrosive battery acid can escape.</p> <ul style="list-style-type: none"> ■ Provide adequate ventilation and remove all sources of ignition, such as open flames, sparks, electric motors, relays, light switches, etc. ■ Equalization voltage is significantly higher than nominal battery voltage. Detach electronics that can be damaged by high DC voltage. <p>Failure to follow these instructions can result in death, serious injury, or equipment damage.</p>

NOTE: In a system where more than one device is capable of equalizing batteries (such as a system including multiple Conext XW Pro units and Conext MPPT solar charge controllers, there is no system-wide equalization command for all devices. To equalize with multiple devices, each would have to be enabled individually. Alternatively, equalization can be performed using only one device. During the equalization process, one device applies the equalization charge while the other devices continue to operate in synchronized charge mode, typically in float (three-stage charging) or no-float (two-stage charging).

AC Settings

 **WARNING**

ADVANCED CONFIGURATION HAZARD

- Advanced menu settings should be used by qualified personnel only.
- Three phase operation should be configured by qualified personnel only.
- Consult with the local utility before enabling Conext XW Pro sell mode or grid support functions.
- Do not change these settings unless you are under the supervision and direction of qualified personnel.
- Connect the Conext Gateway and the network router connected to the Conext Gateway to an assured power source during configuration.

Failure to follow these instructions can result in death, serious injury, or equipment damage.

The **AC Settings** menu configures the voltage and frequency limits for AC port 1 (Grid) and AC port 2 (Gen). These are the limits at which the Conext XW Pro considers AC input voltage qualified—that is, suitable for charging batteries or passing through to loads attached to AC OUT. If the input voltage is not qualified according to these settings, the Conext XW Pro reverts to inverting external DC energy to AC energy for loads on AC OUT.

Table 7 AC Settings Menu

Item	Description
AC Priority	<p>Sets the priority for the AC input source (AC1 or AC2) for qualification and transfer.</p> <p>In systems that use both utility grid (AC1) and generator (AC2) input, it is recommended that you set AC Priority to AC1. Assuming the generator is intended for occasional use only, the Conext XW Pro will use utility power. It will use the generator only if AC1 is unavailable, and if the generator is running.</p>
AC1 Breaker	<p>Sets the AC1 (Grid) breaker size, based on the size of the breaker installed upstream from the AC1 connection port. The installed breaker size must not exceed the capacity of the upstream distribution panel. The Conext XW Pro helps to limit the maximum current draw on AC1 by derating its charging current to an equivalent of 80% of the AC1 breaker setting.</p> <p>However, if the connected loads on AC OUT exceed the AC1 breaker setting, the upstream AC breaker trips. The breaker may not trip if grid support is enabled and battery voltage is above the Grid Support Voltage setting, or if peak load shave is enabled and the load shave time window is active.</p>

Item	Description
AC1 Lo Volt	Minimum acceptable input voltage level from the utility grid.
AC1 Hi Volt	Maximum acceptable input voltage level from the utility grid.
AC1 Lo Freq	Minimum acceptable utility grid input frequency.
AC1 Hi Freq	Maximum acceptable utility grid input frequency.
AC1 Transfer Switch Delay	The time delay between qualifying AC1 and closing its contactor.
AC2 Breaker	<p>Sets the AC2 (Gen) breaker size, based on the size of the installed AC breaker upstream from the AC2 connection port. The installed upstream breaker and the AC2 breaker set point must not exceed the capacity of the generator. The Conext XW Pro helps to limit the maximum current draw on AC2 by derating its charging current to an equivalent of 80% of the AC2 breaker setting.</p> <p>However, if the connected loads on AC OUT exceed the AC2 breaker setting, the upstream AC breaker trips. The breaker may not trip if Gen Support is enabled and Gen Amps is configured not to exceed the generator's rated output current.</p>
AC2 Lo Volt	Minimum acceptable input voltage level from the generator.
AC2 Hi Volt	Maximum acceptable input voltage level from the generator.
AC2 Lo Freq	Minimum acceptable generator input frequency.
AC2 Hi Freq	Maximum acceptable generator input frequency.
AC2 Transfer Switch Delay	The time delay between qualifying AC2 and closing its contactor.
External Contactor Mismatch Fault Delay	<p>The trip time needed to activate fault F72 if the external contactor command does not match the actual status of the external contactor. Adjust this parameter to account for varying close and opening times of the contactors available for use.</p>
Inverter to Grid Overlap	The time delay from closing the external contactor (if equipped) due to grid qualification to exiting grid-forming operation. Depending on the external contactor installed, this value must be tuned to accommodate its closing time reliably. By default, this value is set to 0.015 seconds.
Grid to Invert Delay	The time delay from opening the external contactor (if equipped) due to a grid outage to grid-forming operation. Depending on the external contactor installed, this value must be tuned to accommodate its opening time reliably. By default, this value is set to 0.1 seconds.

For default settings, see "AC Settings Menu" on page 186.

Configuring Nominal Grid Frequency

This adjustment is performed by selecting the appropriate compliance region for each Conext XW Pro. For instance, by selecting California Rule 21-2018, the unit being

configured will adopt a 60 Hz nominal grid frequency. Selecting IEEE 1547-2003 50Hz will similarly configure a 50 Hz nominal grid frequency. All frequency-related functions, including over/underfrequency detection, are based upon these settings. Refer to *"Managing Compliance Regions"* on page 99 for information on how to select a compliance region.

Grid Support Settings

The **Grid Support Settings** menu contains configuration options for grid-tie operation. To enable these settings, **Grid Support** must be enabled in the **Grid Support** menu. Individual grid-interactive features such as PLS and Sell are enabled individually.

In grid support mode, the Conext XW Pro supports the utility grid by limiting the power drawn from the utility to close to zero. This mode is desirable for using excess energy from auxiliary DC sources like PV, while still maintaining a charged battery bank. No power is sold to the utility in this mode.

NOTE: Grid support and sell functions are modes of operation that are subject to local and/or national grid interconnection requirements in most jurisdictions. It is the responsibility of the installer and system operator to ensure that all applicable procedures and technical requirements are complied with before turning on either of these modes. The interconnect codes and standards with which the Conext XW Pro complies are listed in *"Regulatory Approvals"* on page 129.

NOTE: Upon startup, the Conext XW Pro does not enable grid support functions for five minutes (300 seconds). During this period the Conext XW Pro connects to AC input and determines whether the utility grid voltage and frequency are stable and within nominal range. If **Grid Support** is enabled, the inverter information panel also displays a 300 second countdown during this period. For more information, see *"Islanding Protection"* on page 27.

NOTE: In grid support mode, the Conext XW Pro should not draw a large amount of current from the grid. If the Conext XW Pro is drawing more than expected, it is important to note that it cannot distinguish between real power and reactive power. Large current draw will only affect reactive power and not real power, and utility companies generally only charge by real power consumed.

Table 8 Grid Support Menu Values

Setting	Description
Grid Support	Turns the Grid Support feature on and off.
Grid Support Voltage	Sets the voltage level above which Grid Support features are enabled. Takes effect when State of Charge Control is disabled.
Maximum Sell Scale Percentage	Scale the sell current limit with respect to the Maximum Sell Amps setting.
Maximum Sell Amps	Maximum amount of current to sell to the grid.
Load Shave	Turns the Load Shave feature on and off.

Load Shave Amps	The load current above which Peak Load Shaving activates and begins to supplement the power drawn from the grid.
Load Shave Start	The time of day from which Peak Load Shaving is permitted to operate.
Load Shave Stop	The time of day when Peak Load Shaving is no longer permitted to operate.
Sell Block Start	The time of day from which the selling of power to the grid is permitted.
AC PV Charge SoC	The SoC upper limit during grid forming when AC coupled PV inverters are equipped. Below this level, excess power from the PV inverters would charge the battery. As the actual SoC approaches this level, the Conext XW Pro will shift the grid forming frequency to moderate the PV inverter output power as to prevent further charging of the battery. Takes effect when State of Charge Control is disabled
Sell Block End	The time of day when the selling of power to the grid is no longer permitted.
State of Charge Control	Enable if equipped with a Conext Battery Monitor or an external BMS (Eg. With lithium-ion batteries) to utilize State of Charge to control mode transitions instead of battery voltage.
Grid Support SoC	The SoC threshold above which grid support features are enabled. This threshold takes effect when State of Charge Control is disabled
Grid Support SoC Exit Delay	Sets a delay period between when SoC falls below the Grid Support threshold and when grid support functions cease.
EPC Maximum Discharge Power	Maximum battery discharge power available to an external power controller.

For default settings, see "*Grid Support Menu*" on page 187.

Figure 18 Load Shave Mode

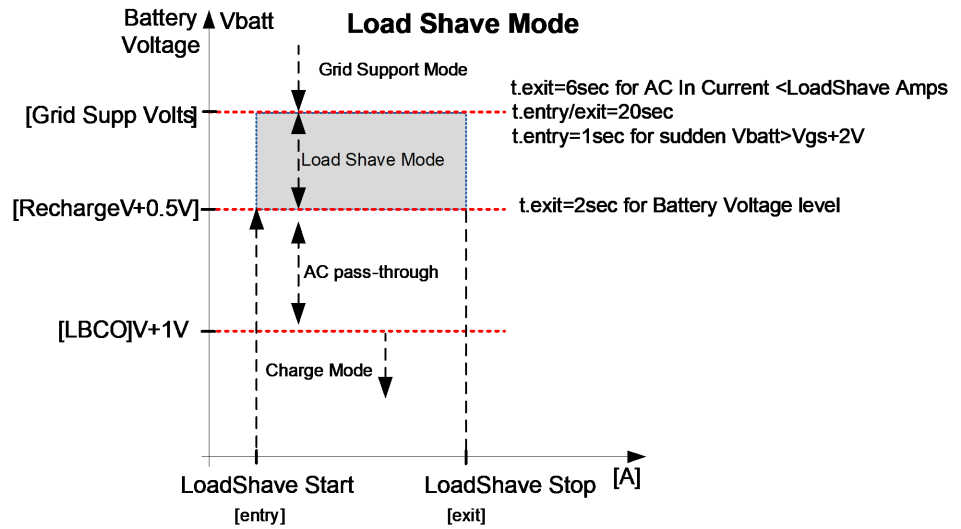

State of Charge Control

Different battery chemistries have associated charge and discharge SOC (State of Charge) versus voltage profiles. Some batteries, such as lead acid, have reasonably large changes in battery voltage across the nominal operating range of 20-80% SOC, allowing the inverter to control battery charging and discharging based on measured voltage. Other batteries, such as Li-Ion, have a very small change in voltage across the nominal 20-80% SOC operating range making control decisions based on battery voltage difficult (see Figure 19 for illustrative purposes only). To accommodate battery chemistries such as these, SOC-based control can be enabled in the Conext XW Pro under the **Grid Support** menu in the **Configuration** tab of the Conext Gateway web application. When enabled, all SOC-based threshold configurations for transitioning between operating modes shall take effect, and their voltage-based counterparts shall be deactivated.

Figure 19 SOC vs. voltage for battery profiles

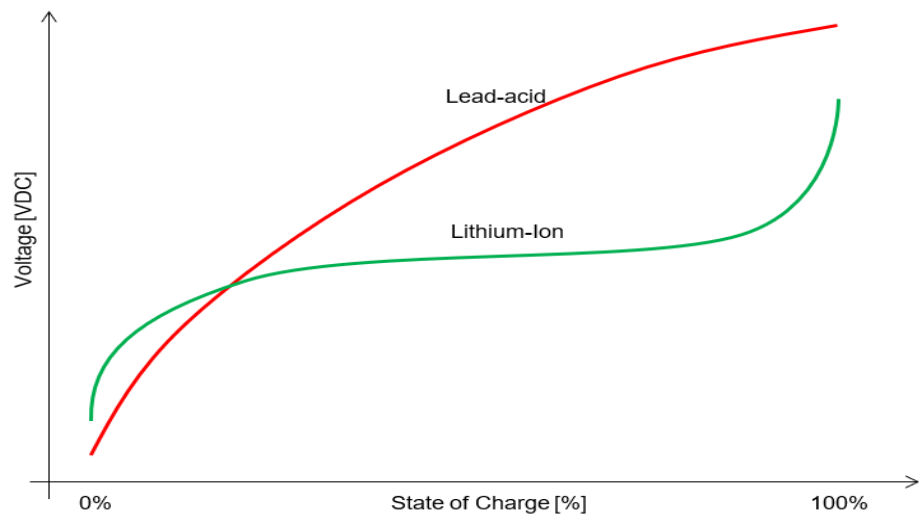

The battery SOC is typically calculated by a third-party Battery Management System, Conext Battery Monitor, or any other external device with such a function. The BMS also ensures safe operation of the batteries by establishing operational limits for the attached inverter-charger unit.

With lead-acid, the Conext XW Pro utilizes battery voltage to transition between operational modes. A duplicate set of SOC-based thresholds are used when State of Charge Control is enabled, and their voltage-based counterparts are ignored. The following figure depicts the SOC settings available assigned with some typical values.

Figure 20 State of Charge Thresholds

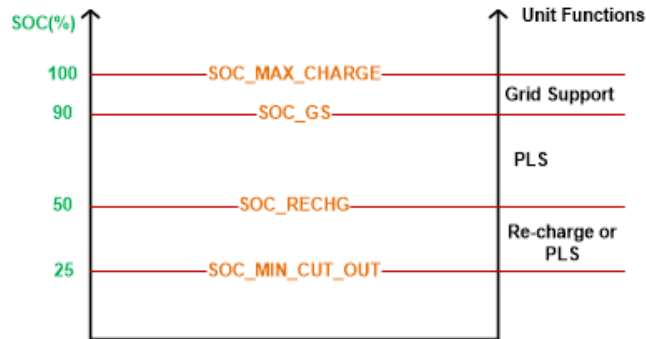

Generator Support Settings

⚠ WARNING

ADVANCED CONFIGURATION HAZARD

- Advanced menu settings should be used by qualified personnel only.
- Three phase operation should be configured by qualified personnel only.
- Consult with the local utility before enabling Conext XW Pro sell mode or grid support functions.
- Do not change these settings unless you are under the supervision and direction of qualified personnel.
- Connect the Conext Gateway and the network router connected to the Conext Gateway to an assured power source during configuration.

Failure to follow these instructions can result in death, serious injury, or equipment damage.

Generator support allows power to be automatically drawn from the batteries to assist an AC generator on AC2 to support heavy loads on AC OUT (loads that exceed the available power from the generator).

Generators have a limited output current and it is possible to reach this limit when operating heavy loads. The Conext XW Pro is designed to assist the generator when heavy current demands load down the generator by supplying additional power from the batteries.

In addition, the battery charger can reduce its charging current to the batteries so the combined AC current required for charging and the total load current do not exceed the capacity of the generator or trip its output breakers or fuses.

For imbalanced loads and small generators, the generator support feature may be used. When **Generator Support Plus** is enabled, the Conext XW Pro will connect the center of its transformer to the AC2 input neutral to act as a load balancing transformer. This feature will attempt to balance the load between L1 and L2. Generator support is most effective for generators under 5 kW. See "Advanced Features" on page 87.

NOTE: The passthrough running and startup (peak) currents of generators attached to AC2 are limited to the maximum current limits of the Conext XW Pro.

NOTE: If generator support is used with generators larger than 5 kW, it is possible for current to recirculate. In this case, the efficiency losses would outweigh the benefit of generator support.

Figure 21 Gen Support Mode Graph

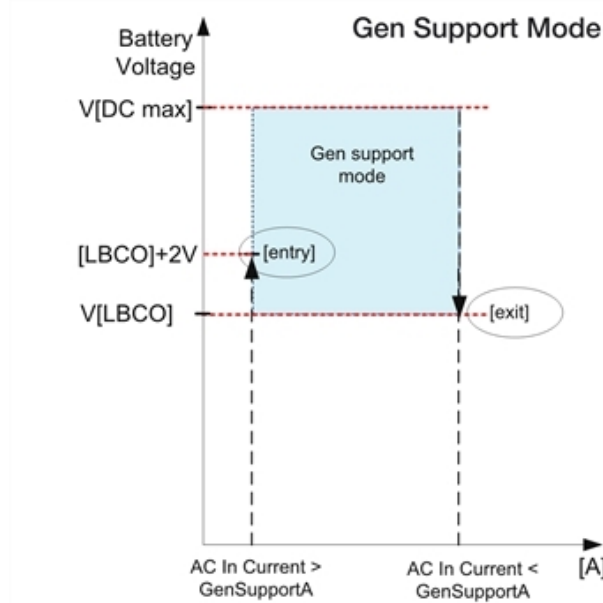

Ensure that the battery bank has sufficient energy to support your loads for the anticipated time period, otherwise draining the battery to LBCO may put the system in Fault mode.

Table 9 Generator Support Menu Values

Setting	Description
Generator Support Mode	Turns the Generator Support feature on and off.
Generator Support Amps	Sets the generator load level at which the Conext XW Pro supplies power from the batteries to support the generator.

NOTE: When **Generator Support Mode** is enabled and actively operating, the Conext XW Pro compensates for active power as a reference for controlling the total current as specified in the **Generator Support Amps** setting. However, there is also reactive power that is not compensated for by the Conext XW Pro. For example, if

Generator Support Amps is set to **48A**, the inverter will only start to assist the generator at a current level which would measure approximately 49A which is 1A higher than the **Generator Support Amps** value.

For default settings, see *Generator Support Menu on page 188*.

AGS Setting in a Multi-Unit System

To prevent the generator from nuisance cycling when the multi-unit Conext XW Pro units are installed with an external contactor (that is, the generator starts and stops in a loop) set **Inverter Load Start/Stop Triggers** to **Disabled** under the **AGS device Configuration** menu in the Conext Gateway web application.

Auxiliary Output Settings

⚠ WARNING

ADVANCED CONFIGURATION HAZARD

- Advanced menu settings should be used by qualified personnel only.
- Three phase operation should be configured by qualified personnel only.
- Consult with the local utility before enabling Conext XW Pro sell mode or grid support functions.
- Do not change these settings unless you are under the supervision and direction of qualified personnel.
- Connect the Conext Gateway and the network router connected to the Conext Gateway to an assured power source during configuration.

Failure to follow these instructions can result in death, serious injury, or equipment damage.

The **Aux** menu allows you to enable and set the auxiliary output. The auxiliary output provides 12 volts DC at 250 milliamps to power a relay, indicator light, or alarm.

NOTE: Changing **Auxiliary Output Trigger Level** resets the auxiliary output. If an auxiliary output trigger is active, changing the trigger level will clear the trigger.

For default settings, see *"Auxiliary Menu" on page 188*.

Table 10 Auxiliary Menu Values

Setting	Description
Auxiliary Output Active Level	Sets the mode (polarity) of the auxiliary output. When triggered, the output can be active high (12 V output turns on) or active low (output is high until the trigger turns it off).
Auxiliary Output Trigger Source	Selects the desired condition (trigger source) to activate the auxiliary output.

The following parameter set controls the activation and de-activation conditions for the Auxiliary Output and are available for each trigger source.

Table 11 Auxiliary Menu Values

Setting	Description
Trigger Set	Sets the voltage or temperature level (depending on the selected trigger source) at which the auxiliary output is activated. If the selected Trigger Source is a battery voltage, the range also varies according to the nominal battery voltage of your system.
Trigger Set Delay	Sets a delay period between when the trigger occurs and when the auxiliary output is activated.
Trigger Clear	Sets the voltage or temperature level (depending on the selected trigger source) at which the auxiliary output becomes inactive.
Trigger Clear Delay	Sets a delay period between when the Trigger Clear setting occurs and when the auxiliary output becomes inactive.

Trigger Source Descriptions

Table 12 Trigger Source Descriptions

Low Battery Voltage	Activates the auxiliary output when the battery voltage falls below Low Battery Voltage after the trigger delay time. The auxiliary output turns off when the battery voltage rises above the clear setting after the Clear Delay time. Use this setting if the auxiliary output needs to control a relay to disconnect loads from a battery or to activate a low battery voltage alarm such as a buzzer or light.
High Battery Voltage	Activates the auxiliary output when the battery voltage rises above High Battery Voltage for the trigger delay time. The auxiliary output turns off when the battery voltage falls below the clear setting for the Clear Delay time. This setting is useful for: <ul style="list-style-type: none"> ■ Installations that have another external charging source such as a wind generator or hydro generator connected directly to the batteries. The Conext XW Pro auxiliary output can control a relay to disconnect the external charging source from the battery or control a relay to turn on a diversion load. ■ Activating a high battery voltage alarm such as a buzzer or light. ■ Activating a vent fan to ventilate the battery compartment.

<p>Low Battery Temperature</p>	<p>Activates the auxiliary output when the battery temperature falls below Low Battery Temperature for the trigger delay time. The auxiliary output turns off when the battery temperature rises above the clear setting for the Clear Delay time. Battery temperature is measured with a battery temperature sensor. Do not use this setting if a battery temperature sensor is not installed.</p>
<p>High Battery Temperature</p>	<p>Activates the auxiliary output when the battery temperature rises above High Battery Temperature for the trigger delay time. The auxiliary output turns off when the battery temperature falls below the clear setting for the Clear Delay time. Battery temperature is measured with a battery temperature sensor. Do not use this setting if a battery temperature sensor is not installed. With this setting, the auxiliary output can turn on a fan to vent the battery compartment.</p>
<p>Heat Sink Overtemperature</p>	<p>Activates the auxiliary output when the heat sink temperature exceeds its trigger set for longer than its set delay. The auxiliary output turns off when the temperature falls below its clear threshold for longer than its clear delay.</p>
<p>Bulk Exit</p>	<p>Exits charge bulk mode. In charge bulk mode, the Conext XW Pro operates as a constant power source to the battery bank. The aux port clears its state when the inverter exits from Bulk charge stage.</p>
<p>Absorption Exit</p>	<p>Exits charge absorption mode and starts the following mode, depending on whether the unit is set to two or three-stage charge. The aux port clears its state when the inverter exits from Absorption charge stage.</p>
<p>Fault</p>	<p>Activates the auxiliary output when a fault occurs. The auxiliary output clears when the fault is cleared.</p>
<p>Battery Low State of Charge</p>	<p>This feature works in conjunction with the Conext Battery Monitor or an external BMS. This auxiliary output is triggered when the state of charge falls outside of the range of 25-90% of total battery charge.</p>
<p>Time of Day</p>	<p>When Time of Day is selected as a trigger source, the Trigger Block Start and Block End become available. Both can be set to a value between 12:00 AM and 11:59 PM. Block Start is when the Auxiliary Output goes into inactive state. Block End is when the Auxiliary Output goes into active state.</p>

Multi-Unit Configuration Menu

WARNING

ADVANCED CONFIGURATION HAZARD

- Advanced menu settings should be used by qualified personnel only.
- Three phase operation should be configured by qualified personnel only.
- Consult with the local utility before enabling Conext XW Pro sell mode or grid support functions.
- Do not change these settings unless you are under the supervision and direction of qualified personnel.
- Connect the Conext Gateway and the network router connected to the Conext Gateway to an assured power source during configuration.

Failure to follow these instructions can result in death, serious injury, or equipment damage.

The **Multi-Unit Config** menu configures the Conext XW Pro to operate as a part of a multi-unit installation.

When installing a multi-unit system, each setting on the **Multi-Unit Config** menu (except for **Dev Name**) must be configured for each Conext XW Pro in the system. The settings should be configured in the following order:

- Dev Number (see "*Device Instance Menu*" on page 193)
- Inverter Mode (see table below)
- Associations (see "*Associations Menu*" on page 191)

Table 13 Multi-Unit Configuration Menu

Item	Description	Default	Range
Inverter Mode	<p>For a multi-unit system to operate in single and split configurations, one Conext XW Pro must be configured to Master and the rest as Slave, otherwise a system-wide fault is asserted.</p> <p>For multi-cluster two or three phase systems, only one multi-phase cluster is to be comprised of Masters of their respective phases (Phase 1 Master, Phase 2 Master, Phase 3 Master), and the remaining clusters as Slaves of their respective phases (Phase 1 Slave, Phase 2 Slave, Phase 3 Slave).</p>	Split Phase Master	<p>Invalid</p> <p>Single Phase</p> <p>Stand Alone</p> <p>Master</p> <p>Slave</p> <p>Split Phase</p> <p>Stand Alone</p> <p>Master</p> <p>Slave</p> <p>Two Phase</p> <p>Phase 1 Master</p> <p>Phase 1 Slave</p> <p>Phase 2 Master</p> <p>Phase 2 Slave</p> <p>Three Phase</p> <p>Stand Alone</p> <p>Master</p> <p>Slave</p> <p>Phase 1 Master</p> <p>Phase 1 Slave</p> <p>Phase 2 Master</p> <p>Phase 2 Slave</p> <p>Phase 3 Master</p> <p>Phase 3 Slave</p>

For default settings, see "Multi-unit Configuration Menu" on page 190.

Associations Settings

 **WARNING**

ADVANCED CONFIGURATION HAZARD

- Advanced menu settings should be used by qualified personnel only.
- Three phase operation should be configured by qualified personnel only.
- Consult with the local utility before enabling Conext XW Pro sell mode or grid support functions.
- Do not change these settings unless you are under the supervision and direction of qualified personnel.
- Connect the Conext Gateway and the network router connected to the Conext Gateway to an assured power source during configuration.

Failure to follow these instructions can result in death, serious injury, or equipment damage.

The Associations menu contains additional settings to allow the Conext XW Pro to function as part of a multi-unit networked system.

Setting the connections for a Xanbus-enabled device provides a way of identifying non-network associations for Xanbus-enabled devices and enhancing networked power system management. When connections are set, devices of different types become associated and can share sources, e.g. a common DC input source, or a common grid/generator source.

In multi-unit networked systems, multiple inverterchargers can be stacked to produce increased charge current. To achieve this functionality, the devices must be configured to the same DC connection, such as House Battery Bank 1. The units will collaborate on battery charging by communicating with other units on this shared DC connection.

NOTE: When configuring clusters of three Conext XW Pro units (or a grouping of up to six in a grid-tie application), each cluster's DC connections must be set to the same battery bank. If one of the units is set with a different DC connection, a system configuration fault (F66) occurs.

Table 14 Associations Menu

Item	Description
Battery Association	DC input and output connection. This is the common DC connection shared between the Conext XW Pro, charge controllers, and referenced by the Conext AGS.

Item	Description
AC Output Association (Loads)	AC output connection. This connection specifies a common AC output connection shared between Conext XW Pro units. The AC output connection has to be configured so that the units know if they are connected to the same load or not. If connected to the same load, select the same name on all units; for example, "ACLoad1." If connected to separate load banks, use different names for the AC output connection on each unit; for example, "ACLoad1" on one unit and "ACLoad2" on the other.
AC1 Association (Grid)	AC1 input connection. This connection specifies a common AC port 1 input for multiple Conext XW Pro units.
AC2 Association (Generator)	AC2 input connection. This connection specifies a common AC port 2 input for multiple Conext XW Pro units.

For default settings, see "Associations Menu" on page 191.

Figure 22 Conext XW Pro Connections Representation

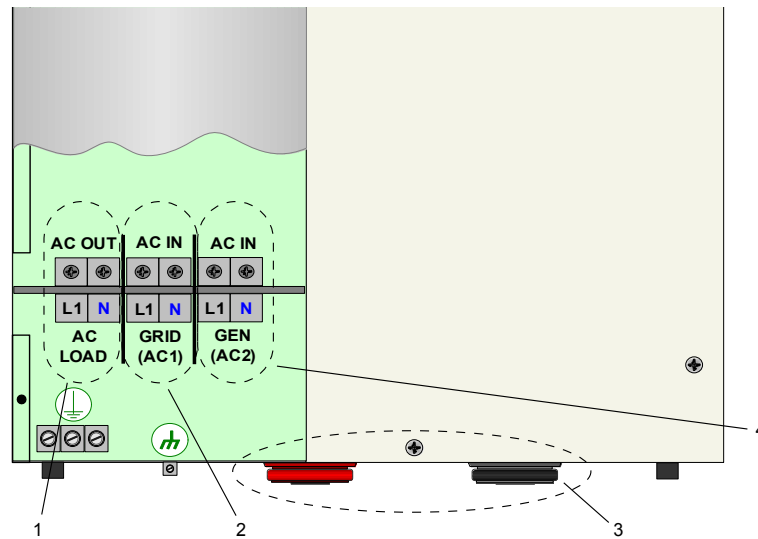

1	AC Out Connection: Select AC Load 1 to 10
2	AC1 Connection: Select Grid 1 to 10, Generator 1 to 10
3	DC Connection: Select House Battery Bank 1 to 5
4	AC2 Connection: Select Grid 1 to 10, Generator 1 to 10

Advanced Features

 WARNING
<p>ADVANCED CONFIGURATION HAZARD</p> <ul style="list-style-type: none"> ■ Advanced menu settings should be used by qualified personnel only. ■ Three phase operation should be configured by qualified personnel only. ■ Consult with the local utility before enabling Conext XW Pro sell mode or grid support functions. ■ Do not change these settings unless you are under the supervision and direction of qualified personnel. ■ Connect the Conext Gateway and the network router connected to the Conext Gateway to an assured power source during configuration. <p>Failure to follow these instructions can result in death, serious injury, or equipment damage.</p>

Table 15 Advanced Features Menu

Item	Description
Remote Power Off	Enables or disables the Remote Power Off function. Enable this setting if an external switch has been connected to the Conext XW Pro auxiliary port. See the <i>Conext XW Pro Installation Guide</i> for more information about the auxiliary port.
Power Save	When enabled, power save mode can reduce tare loss from the battery by reducing output from 240 volts to 220 volts when the loads are less than 100 watts. When the Conext XW Pro detects loads higher than 100 watts, it produces the full 240 volts. Power Save mode is disabled by default.
Sell Delay 40 Sec	When enabled—and other conditions are satisfied—there will be a 40 second delay before the system starts exporting energy to the grid. When disabled, the default value of 20 seconds is used. This feature is useful when the battery voltage is not constant. It also helps avoid power fluctuations during sell. As an exception, there will be zero time delay when the battery voltage suddenly rises to 2 V above Grid Support Voltage . For example, a wind turbine or micro hydro connected to a small battery bank may create a sudden change on the battery voltage. In this case the system will immediately respond to convert the energy from the battery to grid.

Item	Description
<p>Generator Support Plus</p>	<p>When Generator Support Plus is enabled, the Conext XW Pro will connect the center of its transformer to the AC2 input neutral to act as a load balancing transformer. This feature will attempt to balance the load between L1 and L2. See "<i>Generator Support Settings</i>" on page 78 for more details..</p>
<p>AC Coupling</p>	<p>AC Coupling function is enabled by default (Advanced Features Menu) and should remain enabled except in cases where the DC voltage level is allowed to have large variations and the AC line frequency needs to remain constant.</p>
<p>Battery Energy Balance</p>	<p>The Battery Energy Balance function is disabled by default and is intended for use with inverters drawing power from a single battery bank. The Battery Energy Balance function should be enabled when Conext XW Pro units are used in multi-unit systems with multiple battery banks. When enabled this feature helps balance the power draw across multiple battery banks.</p>
<p>Peak Load Shaving Delay</p>	<p>When enabled, Peak Load Shaving mode is delayed by 2 hours to allow the MPPT solar charge controller to charge the battery bank first, then when the timer of 2 hours expires, the unit enters Peak Load Shaving mode for AC load support.</p>
<p>External Transfer Contactor</p>	<p>Enable if an external transfer contactor between the grid point of connection and the Inverter-Chargers is present. Refer to the Conext XW Pro Multi-unit Power System Design Guide (document number 990-91373) for an overview guide. Refer to "<i>Multi-Unit Configuration Menu</i>" on page 83 for additional configuration settings required in a multi-unit set up involving an external contactor.</p>
<p>External Load Switch</p>	<p>Enable if an external load/transfer switch is present. Refer to the Conext XW Pro Multi-unit Power System Design Guide (document number 990-91373) for an overview guide.</p>

For default settings, see "*Advanced Features Menu*" on page 191.

Advanced Device Settings

 WARNING
<p>ADVANCED CONFIGURATION HAZARD</p> <ul style="list-style-type: none"> ■ Advanced menu settings should be used by qualified personnel only. ■ Three phase operation should be configured by qualified personnel only. ■ Consult with the local utility before enabling Conext XW Pro sell mode or grid support functions. ■ Do not change these settings unless you are under the supervision and direction of qualified personnel. ■ Connect the Conext Gateway and the network router connected to the Conext Gateway to an assured power source during configuration. <p>Failure to follow these instructions can result in death, serious injury, or equipment damage.</p>

Table 16 Advanced Device Settings Menu

Item	Description
Periodic Transmit Enable	When enabled the Conext XW Pro will periodically transmit status messages over the Xanbus to all networked monitoring devices. This is enabled by default and required when operating networked with other monitoring devices.
Identify Enable	When Enabled, all illumination elements of the front panel of the Conext XW Pro will flash rapidly to identify itself to the currently selected Inverter-Charger instance in the web application.

For default settings, see "Advanced Device Settings Menu" on page 191.

Battery Management System Settings

 WARNING
<p>ADVANCED CONFIGURATION HAZARD</p> <ul style="list-style-type: none"> ■ Advanced menu settings should be used by qualified personnel only. ■ Three phase operation should be configured by qualified personnel only. ■ Consult with the local utility before enabling Conext XW Pro sell mode or grid support functions. ■ Do not change these settings unless you are under the supervision and direction of qualified personnel. ■ Connect the Conext Gateway and the network router connected to the Conext Gateway to an assured power source during configuration. <p>Failure to follow these instructions can result in death, serious injury, or equipment damage.</p>

Table 17 Battery Management System Menu

Item	Description
Fault on loss of BMS status information	Configures the Conext XW Pro response to lost BMS Status message from the Conext Gateway. Set to Enabled to configure the Conext XW Pro to activate Fault F90 and go offline, and to Disabled to configure it to activate Warning W90 and use measured battery voltage for control until communications of BMS status information is restored..
BMS Status Lost Fault Trip time	The time delay from the moment the BMS Status message from the Conext Gateway is lost to the Conext XW Pro activating W90 if Fault on loss of BMS status information is disabled, or F90 if enabled.
Charge Voltage Limit (BMS status lost)	The default charge voltage limit applied when the value normally provided by the associated Battery Management System is no longer being received.
Discharge Voltage Limit (BMS status lost)	The default discharge voltage limit applied when the value normally provided by the associated Battery Management System is no longer being received.
Charge Current Limit (BMS status lost)	The default charge current limit applied when the value normally provided by the associated Battery Management System is no longer being received.
Discharge Current Limit (BMS status lost)	The default discharge current limit applied when the value normally provided by the associated Battery Management System is no longer being received.
Charge Overcurrent Offset	Offset added to the charge overcurrent limit broadcasted by the associated BMS. The resulting threshold becomes the Conext XW Pro's own charge overcurrent limit.
Charge Overcurrent Trip Time	The time delay from the moment charge current exceeds the threshold determined above until the Conext XW Pro activates fault F73.
Discharge Overcurrent Offset	Offset added to the discharge overcurrent limit broadcasted by the associated BMS. The resulting threshold becomes the Conext XW Pro's own discharge overcurrent limit.
Discharge Overcurrent Trip Time	The time delay from the moment discharge current exceeds the threshold determined above until the Conext XW Pro activates fault F71.
DC Undervoltage Offset	Offset added to the undervoltage limit broadcasted by the associated BMS. The resulting threshold becomes the Conext XW Pro's own undervoltage limit.

DC Undervoltage Trip Time	The time delay from the moment battery voltage exceeds the threshold determined above until the Conext XW Pro activates fault F74.
DC Overvoltage Offset	Offset added to the overvoltage limit broadcasted by the associated BMS. The resulting threshold becomes the Conext XW Pro's own overvoltage limit.
DC Overvoltage Trip Time	The time delay from the moment battery voltage exceeds the threshold determined above until the Conext XW Pro activates fault F75.
Fault on loss of State of Charge information	Configures the Conext XW Pro response to lost BMS State of Charge from the Conext Gateway. Set to Enabled to configure the Conext XW Pro to go offline, and to Disabled to configure it to use measured battery voltage for control.

For default settings, see "Battery Management Systems Menu" on page 192.

Device Instance Settings

⚠ WARNING
ADVANCED CONFIGURATION HAZARD
<ul style="list-style-type: none"> ■ Advanced menu settings should be used by qualified personnel only. ■ Three phase operation should be configured by qualified personnel only. ■ Consult with the local utility before enabling Conext XW Pro sell mode or grid support functions. ■ Do not change these settings unless you are under the supervision and direction of qualified personnel. ■ Connect the Conext Gateway and the network router connected to the Conext Gateway to an assured power source during configuration.
Failure to follow these instructions can result in death, serious injury, or equipment damage.

Table 18 Device Instance Menu

Item	Description
Device Number	Allows setting of a unique unit number in a multiple-unit system. In multi-unit configurations, the Conext XW Pro designated as the Master must be assigned the Device Number of 1.
Device Name	Allows customization of the default device name. This setting is optional and does not affect operation.
System Instance	Identifies the Xanbus association of all devices on the same network. Accepts numerical values only.

For default settings, see "Device Instance Menu" on page 193.

Modbus Settings

⚠ WARNING

ADVANCED CONFIGURATION HAZARD

- Advanced menu settings should be used by qualified personnel only.
- Three phase operation should be configured by qualified personnel only.
- Consult with the local utility before enabling Conext XW Pro sell mode or grid support functions.
- Do not change these settings unless you are under the supervision and direction of qualified personnel.
- Connect the Conext Gateway and the network router connected to the Conext Gateway to an assured power source during configuration.

Failure to follow these instructions can result in death, serious injury, or equipment damage.

Table 19 Modbus Settings Menu

Item	Description
Modbus Slave Address (Port 502)	Port 502 is the Sunspec-compliant port for all Sunspec devices. The default address is 10.
Modbus Slave Address (Port 503)	Port 503 is used for all other Modbus devices, including legacy devices. The default address is 10.

For default settings, see "Modbus Settings Menu" on page 193.

Prioritizing and Managing Energy Sources with Advanced Features

The Conext XW Pro can be programmed to control how and when to use utility power as well as external DC sources of energy such as batteries and solar charge controllers. Advanced features allow management of peak loads, time-of-use billing and self consumption.

Grid Support

WARNING

ADVANCED CONFIGURATION HAZARD

- Advanced menu settings should be used by qualified personnel only.
- Three phase operation should be configured by qualified personnel only.
- Consult with the local utility before enabling Conext XW Pro sell mode or grid support functions.
- Do not change these settings unless you are under the supervision and direction of qualified personnel.
- Connect the Conext Gateway and the network router connected to the Conext Gateway to an assured power source during configuration.

Failure to follow these instructions can result in death, serious injury, or equipment damage.

NOTE: Grid support and sell functions are modes of operation that are subject to local and/or national grid interconnection requirements in most jurisdictions. It is the responsibility of the installer and system operator to ensure that all applicable procedures and technical requirements are complied with before turning on either of these modes. The interconnect codes and standards with which the Conext XW Pro complies are listed in "*Conext XW Pro Overload Capability*" on page 125.

The grid support mode allows the Conext XW Pro to support local loads by converting excess capacity from external DC sources connected to its battery bank. Examples of external DC sources are solar charge controllers and batteries.

For Grid Support to function, Grid Support must be enabled on the Grid Support menu and either the battery voltage must be above the **Grid Support Voltage** setting or SoC must be above **Grid Support SoC** setting, depending on whether or not **State of Charge Control** is enabled."

There are two modes of operation within Grid Support.

Grid Support Enabled, Sell Disabled

In this mode, available excess DC power is converted and used to power local loads. No power is exported to the utility. If the local load demand exceeds the available power from the external DC sources, power is then drawn from the utility to support the load. However, if the local load demand is less than the power available from external DC sources, the net excess power from the external DC sources is not converted and hence not used.

Grid Support Enabled, Sell Enabled

In this mode, all available excess DC power is first used to power local loads. Any remaining power is exported to the utility grid.

Note: To comply with anti-islanding requirements, in a grid tied AC coupled system, change the AC1 Transfer Delay setting under AC Transfer Configuration to 300 seconds.

Sell Block

The sell block feature halts the export of energy to the grid connected to AC1 for a period of time each day. This period of time is defined by the Sell Block Start and Sell Block Stop settings. Sell Block can be useful in managing the self consumption of renewable energy.

Note: Sell block will not block selling from an AC coupled inverter.

Grid Support and Battery Charging

Charge Cycle Settings

With the charger enabled, the Conext XW Pro enters grid support mode only after completing a charge cycle when it is first powered up or reconnected to the grid. Unless an external BMS is installed with Charge Cycle set accordingly, set the Conext XW Pro Charge Cycle to two-stage (default) to allow grid support to function immediately after the absorption charge stage is completed. See "*Charger Settings*" on page 59 for more information.

NOTE: Only the Conext XW Pro needs to be set to two-stage charging. The Conext MPPT solar charge controllers can remain set for three-stage charging. The Conext XW Pro should be set in two-stage charging and the charge controllers set in three-stage for solar charging to occur properly. Alternately, charger block can be used to for correct charging. See "*Charger Settings*" on page 59 for further information.

Grid Support modes

Grid Support can be configured to operate in one of two modes:

- Grid Support with DC Sources Not Communicating Over Xanbus
- Enhanced Grid Support with Conext MPPT Solar Charge Controllers

At this time, **State of Charge Control** is not supported with any sort of DC-coupled sources.

Grid Support with DC Sources Not Communicating Over Xanbus

This setup is suitable for use with DC sources (such as wind turbines, DC generator sets, fuel cells, and so on) that do not communicate with the Conext XW Pro through Xanbus or for mixed systems which have both Xanbus-connected Conext Solar Charge Controllers and other DC sources (such as those listed above). **Grid Support Voltage** is set 0.5 volts below the voltage provided by the DC source (typically the float voltage setting of the DC source or charge controller). See *Figure 17 on page 71*.

Schneider Electric does not provide support for these energy sources.

In a 'fixed' battery voltage system configuration, the Conext XW Pro manages the battery voltage to the **Grid Support Voltage** setting. This is done by converting the available DC power to AC power to support the AC loads attached to the inverter output or exports to the utility grid (AC1). Because the battery bank voltage may not reach bulk/absorption voltages in this mode, it is recommended to occasionally force a full charge cycle by either temporarily disabling grid support or forcing a bulk charge cycle from the grid (see **Force Charger State** in "Controls Settings" on page 54).

Enhanced Grid Support with Conext MPPT Solar Charge Controllers

This setup is suitable for Conext Systems with only Conext MPPT Solar Charge Controller(s) networked to Conext XW Pro units through Xanbus. In this configuration, **Grid Support Voltage** is set above the charge controller's Equalization voltage (for example, 64 volts).

In an enhanced grid support set up the Conext XW Pro automatically tracks the Conext MPPT Solar Charge Controller voltage as it transitions through charge states (from bulk to absorption to float). This allows the system to execute a complete battery charge cycle while still converting excess DC power to AC power to support the AC loads or be exported to the utility grid. In doing so, the Conext XW Pro only uses excess DC not required by the battery or used to support local AC loads and sells it to the grid, thereby maximizing the use of the PV array. Since this set up allows the battery bank voltage to reach absorption levels (when PV harvest is adequate), the state of health of the battery is improved. The sell entry and regulation voltage level is 1 V below absorption and float of the Conext Solar Charge Controller set points. The exit from sell is 1.5 V below absorption and float of the Conext Solar Charge Controller set points.

Figure 23 Charger Block

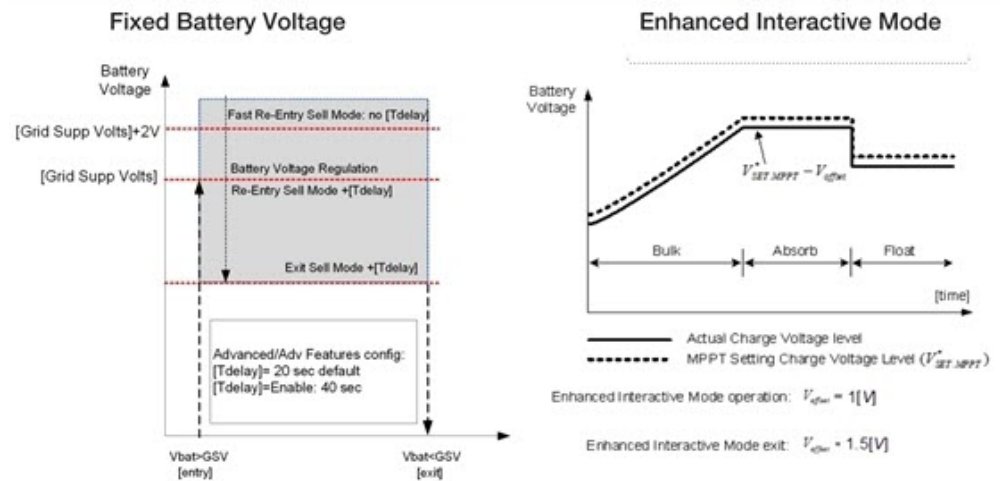

NOTE: [Tdelay] is an entry/exit transition time delay to/from grid support and sell mode. If the battery voltage has higher fluctuations due to DC renewable sources (e.g. charge controllers, wind turbines, and so on), then the time delay can be increased by setting **Sell Delay 40 Sec** to enabled (refer to "Advanced Features" on page 87). If the battery voltage has a sudden increase change greater than **Grid Support Volts + 2 V**, then the Conext XW Pro will override the delay and enter grid support or sell mode immediately.

Charger Block

The charger block feature halts charging on AC1 (Grid) for a period of time each day. This period of time is defined by the **Charge Block Start** and **Charge Block Stop** settings. In areas where the utility charges variable rates for electricity, it is preferable to use utility power for charging only during non-peak hours. Charger block can prevent utility power from being used for battery charging during peak billing periods.

During the time period set between **Charge Block Start** and **Charge Block Stop**, AC1 (Grid) input continues to be passed through to the loads. Inverter operation remains unaffected during the charger block period.

During the charger block period, no charging on AC1 occurs even if the batteries discharge below **Recharge Voltage/SoC** setting. However, a generator connected to AC2 (in the absence of utility/AC1 power) or a Conext MPPT solar charge controller may charge batteries during the charger block period. AC priority must be set to AC2 to charge batteries with a generator connected to AC2 during the charger block period.

If the charger is operating (that is, in float, absorption, bulk, or equalize stage) at the **Charge Block Start** time, charging on AC1 stops immediately and the charger enters an idle state identical to no float (see "*Charger Settings*" on page 59). When the charger block period is over, the charger does not resume the charge stage that was interrupted. Instead, if the batteries are above the **Recharge Voltage/SoC** setting, the charger remains idle.

If the battery voltage discharges below the **Recharge Voltage/SoC** setting during the charger block period, the Conext XW Pro begins a new charge cycle with the bulk stage after the charger block period has expired (at the **Charge Block Stop** time).

For example, charger block is set to start at 5:00 PM and end at 8:00 PM. If the Conext XW Pro is charging from AC1, charging stops at 5:00. When charger block ends at 8:00, the Conext XW Pro does not automatically resume charging. The unit first measures the battery voltage.

- If the voltage is below the **Recharge Voltage** setting, or if the state of charge is below **Recharge SoC**, then the Conext XW Pro starts a new charge cycle from bulk.
- If the voltage is above the **Recharge Voltage** setting, or if the state of charge is above **Recharge SoC**, then the Conext XW Pro remains idle and continues passing through AC to the loads.

The Conext XW Pro also keeps measuring the battery voltage as before to determine whether to start a new charge cycle.

Peak Load Shaving (PLS)

Many utilities impose a surcharge on their customers based on the peak load used by a facility. To reduce utility peak demand charges, the inverter can be configured (using the **Load Shave Amps** setting) to help limit the maximum draw the AC loads place on the utility. The inverter can be programmed to provide power above a specified level to avoid the surcharge. When the utility current draw reaches the maximum level, the inverter assists by sourcing power from the batteries to the loads.

For PLS to be effective, all loads must be connected to the inverter. For large loads, multiple (or stacked) inverters may be required.

To help the batteries supplement the power requirements of the connected load, an additional source of power (solar, wind, or hydroelectric) is recommended.

The default PLS setting for Time in Float is zero. In this case, PLS is only entered/exited as programmed within the time window.

When the Time in Float is different than zero, PLS shall start only if the battery amperage remained at the specified level for the configured time.

Example Settings

```
Load Shave=Enabled, Load Shave Amps=10 A,  
LoadShaveStart=6:00pm, LoadShaveStop=9:00pm, Time in Float=60  
min, Peak Load Shave Delay = Enabled
```

With these example settings, the Conext XW Pro would enter PLS within the configured window of time only if the battery was charged from MPPT in Float (including Absorption) for 2 hours.

NOTE: When actively operating, the Conext XW Pro compensates for active power as a reference for controlling the total current as specified in the **Load Shave Amps** setting. However, there is also reactive power that is not compensated for by the Conext XW Pro. For example, if **Load Shave Amps** is set to 10A, the inverter will only start drawing power from the batteries at a current level which would measure approximately 11A which is 1A higher than the **Load Shave Amps** value to meet the demand of the loads.

Time-of-Use Metering

Utilities use time-of-use metering to determine utility charges during peak usage hours and to impose a surcharge. The Conext XW Pro can be configured (using the **Load Shave Start**, **Load Shave Stop** and **Charger Block** settings) to overcome these peak charges by using utility power to charge the battery bank during the inexpensive energy hours and consuming the battery energy during expensive energy hours.

For example, if **Charger Block** is set between 9:00 AM and 10:00 PM and **Load Shave** is set between 6:00 PM and 9:00 PM, charging on AC1 stops at 9:00 AM and continues to pass through utility AC to the loads. If charging is required during the charger block period, and **AC Priority** is set to AC2, the Conext XW Pro can use any AC source connected to AC2. Loads will transfer to the AC source on AC2 as well. The inverter connects to the utility grid at 6:00 PM and supports loads using the batteries. The inverter continues to run until 9:00 PM. The Conext XW Pro then stops supporting the utility grid and passes utility AC through to the loads. At 10:00 PM utility AC begins maintaining the batteries based on the battery charger settings.

The above example allows an external renewable energy source to be utilized as a primary charging source during a desired time window. The charger (using utility AC connected to AC1) can then be used to supplement the battery charging when the utility rates are low.

When using the system for time-of-use metering, the system should be designed with a battery capacity large enough to support loads during the entire peak rate period without reaching the **Low Battery Cut Out** or **Low Battery Cut Out SoC** setting.

NOTE: If the batteries reach the Low Battery Cut Out setting, the Conext XW Pro automatically reconnects to the utility grid to maintain the connected load.

Self-Consumption

PLS can also be used with time-of-use metering to support self-consumption. In the self-consumption mode of operation, the Conext XW Pro delays Peak Load Shave mode by a fixed time of 2 hours. This is done by allowing a priority for the MPPT solar charge controller to charge the battery bank.

This configuration can be selected under the Conext XW Pro menu by setting **Peak Load Shaving Delay** under Advanced Features to **Enabled**. The default setting for is **Disabled**.

Managing Firmware

The firmware running on the Conext XW Pro can be upgraded under the **Firmware** tab in the Conext XW Pro menus. A single firmware binary file can be pushed to all networked Conext XW Pros by loading the file and selecting **Upgrade All XWs**. Firmware can be downloaded from <https://solar.schneider-electric.com/>.

Figure 24 Upgrading Firmware

Conext Gateway Version: v1.07DEV | Build number: 172 | Conext Gateway 2020/03/04 18:52 | Admin 3 | Disclaimer | Logout Life Is On Schneider Electric

Dashboard Devices Events Setup About

Device Overview
Inverter/Chargers
 Other Devices
 Meters

Inverter/Charger: XW6848-21 0 [Change Selection](#)

Status	Performance	Events	Configuration	Diagnostics	Firmware	Grid Codes
					<p>Firmware Version 1.06.00</p> <p>Build Version 386</p>	

Please select the firmware, ending with the file extension .xf0 or .xf1

Upgrade Upgrade All XWs

XW6848-21 0
Online

FGA 865-6848-21

Device Name XW6848-21

Serial Number 00001AB4EC98

Unique Identifier 1371288

Bus Id 1

Xanbus Address 0

Build Number 1.06.00bn386

Managing Compliance Regions

⚠ WARNING

ADVANCED CONFIGURATION HAZARD

- Advanced menu settings should be used by qualified personnel only.
- Three phase operation should be configured by qualified personnel only.
- Consult with the local utility before enabling Conext XW Pro sell mode or grid support functions.
- Do not change these settings unless you are under the supervision and direction of qualified personnel.
- Connect the Conext Gateway and the network router connected to the Conext Gateway to an assured power source during configuration.

Failure to follow these instructions can result in death, serious injury, or equipment damage.

The **Grid Codes** tab in the Conext XW Pro menus provides access to the autonomous grid interactive functionality including active/reactive power curves and ride-through profiles. By selecting the applicable grid compliance region, the Conext XW Pro immediately makes all the appropriate configurations to conform with the requirements of that region, which in turn also sets the nominal grid frequency of the unit. Further adjustments of these functions can be applied after selecting a compliance region. The menu options in this page are password protected.

Figure 25 Compliance Regions

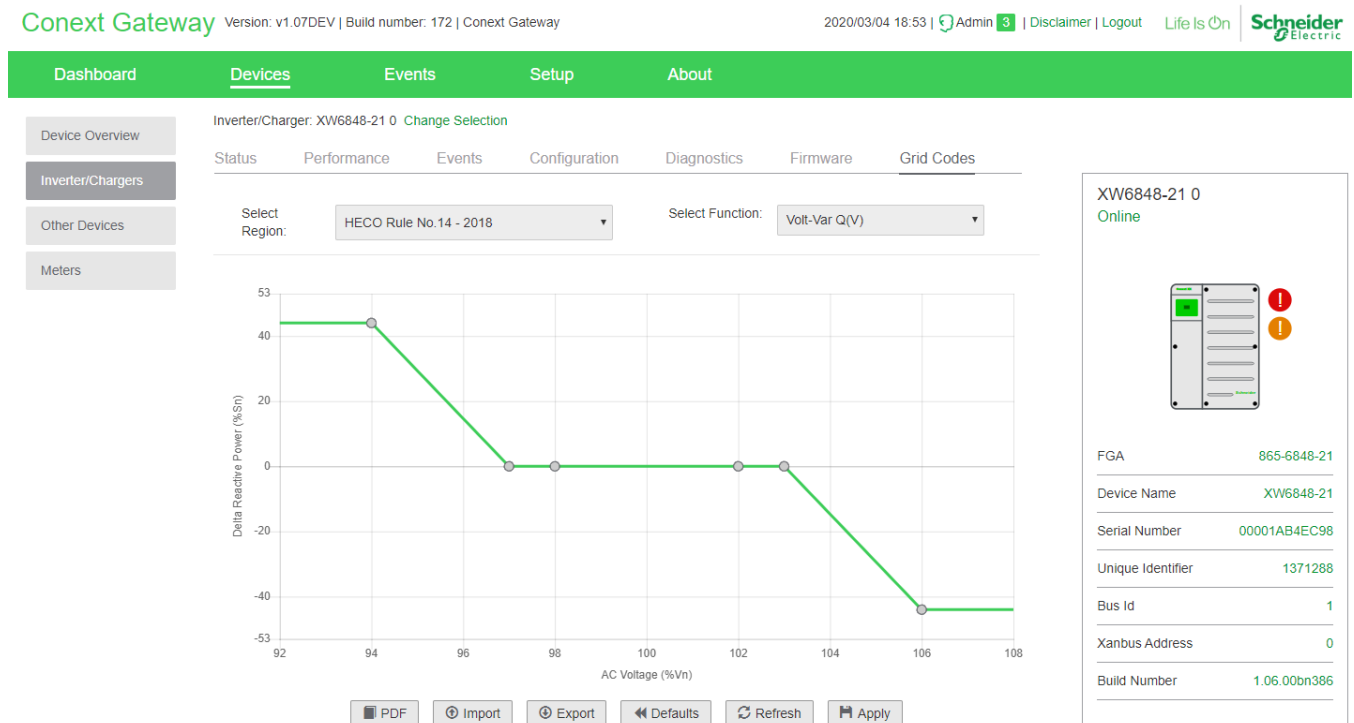

Resetting the Conext XW Pro to Default Settings

WARNING

ADVANCED CONFIGURATION HAZARD

- Advanced menu settings should be used by qualified personnel only.
- Three phase operation should be configured by qualified personnel only.
- Consult with the local utility before enabling Conext XW Pro sell mode or grid support functions.
- Do not change these settings unless you are under the supervision and direction of qualified personnel.
- Connect the Conext Gateway and the network router connected to the Conext Gateway to an assured power source during configuration.

Failure to follow these instructions can result in death, serious injury, or equipment damage.

The **Reset to Factory** command returns the Conext XW Pro to factory default settings. After using the **Reset to Factory** command, the Conext XW Pro is no longer configured for the power system.

NOTICE

RESTORING DEFAULTS

Do not restore defaults while the Conext XW Pro is operating. De-energize the power system and disconnect the Conext XW Pro AC input before restoring defaults. Reconfigure the Conext XW Pro before reconnecting the AC input and re-energizing the power system.

Failure to follow these instructions can result in equipment damage.

To restore the Conext XW Pro default settings, on the **Controls Setup** menu in the **Advanced** view, select **Reset to Factory** for the **Reset** control.

5 Troubleshooting

What's in This Chapter?

General Troubleshooting Guidelines	102
Inverter Applications	103
Resistive Loads	103
Motor Loads	103
Problem Loads	103
Inverter Troubleshooting	105
Battery Charger Troubleshooting	108
Faults and Warnings	110
Warning Messages	110
Fault Messages	113

General Troubleshooting Guidelines

This section will help you narrow down the source of any problem you may encounter. Please read the following troubleshooting steps:

1. Check for a Warning or Fault message on the Conext Gateway web application or a Fault code on the inverter information panel. If a message is displayed, record it immediately.
2. As soon as possible, create a detailed record of the conditions at the time the problem occurred. These details should include, but not be limited to, the following:
 - Loads the Conext XW Pro was running or attempting to run.
 - Battery condition at the time of failure (for example battery voltage or temperature) if known.
 - Recent sequence of events (for example, charging had just finished, utility grid had failed but the inverter did not start up).
 - Any known unusual AC input factors such as low voltage or unstable generator output.
 - Extreme conditions which may have existed at the time (for example, temperature or moisture).
3. Attempt the solution corresponding to the Warning or Fault message in *Faults and Warnings on page 110*.
4. If the Event LED is not lit up on the front of the inverter information panel or the Conext Gateway web application shows no event, check the following list to make sure that the present state of the installation allows proper operation of the unit. See also *"Inverter Troubleshooting" on page 105* or *"Battery Charger Troubleshooting" on page 108*.
 - Is the Conext XW Pro located in a clean, dry, adequately ventilated area?
 - Have the AC input breakers opened? If so, your passthrough load may have exceeded the rating of one or more of the input breakers.
 - Are the battery cables adequately sized and short enough? See the *Conext XW Pro Installation Guide* for more information.
 - Is the battery in good condition and are all DC connections tight?
 - Are the AC input and output connections and wiring in good condition?
 - Are the configuration settings correct for your particular installation?
 - Are the display panel and the communications cable properly connected and undamaged?
 - Are the battery temperature sensor and its cable properly connected and undamaged?
5. Contact Customer Service for further assistance. Please be prepared to describe details of your system installation and provide the model and serial number of the unit. See beginning of document for contact information.

Inverter Applications

The Conext XW Pro performs differently depending on the AC loads connected to it. If you are having problems with any of your loads, read this section.

Resistive Loads

Resistive loads are the easiest and most efficient to drive. Voltage and current are in phase, which means they are in step with one another. Resistive loads generate heat in order to accomplish their tasks. Toasters, coffee pots, and incandescent lights are typical resistive loads. It is usually impractical to run larger resistive loads—such as electric stoves and water heaters—from an inverter due to their high current requirements. Even though the inverter may be able to accommodate the load, the size of battery bank will limit inverter run time.

Motor Loads

Induction motors (AC motors without brushes) require up to six times their running current on startup. The most demanding are those that start under load (for example, compressors and pumps). Of the capacitor start motors (typical in tools such as drill presses and band saws), the largest you can expect to run is 1 horsepower. Universal motors are generally easier to start. Check that the Locked Rotor Amps (LRA) rating of the motor load does not exceed the maximum surge current rating of the inverter. Since motor characteristics vary, only testing will determine whether a specific load can be started and how long it can be run.

If a motor fails to start within a few seconds or loses power after running for a time, it should be turned off. When the inverter attempts to start a load that is greater than it can handle, the inverter may shut down from an AC overload fault.

Problem Loads

Very Small Loads

If the power consumed by a device is less than the threshold of the search mode circuitry, and search mode is enabled, the inverter will not run. Most likely the solution will be to disable **Search** mode or lower the sense threshold (see *"Inverter Settings" on page 55*).

Fluorescent Lights and Power Supplies

Some devices cannot be detected when scanned by search mode circuitry. Small fluorescent lights are the most common example. Some computers and sophisticated electronics have power supplies that do not present a load until line voltage is available. When this occurs, each unit waits for the other to begin. To drive these loads, either a small companion load like a light bulb rated for more than the **Search Watts** setting must be used to bring the inverter out of search mode, or the inverter may be programmed to remain on by disabling search mode (see *"Inverter Settings" on page 55*).

Clocks

You may notice that your clocks are not accurate. Some of the clocks on your appliances may reset when the Conext XW Pro is in search mode. Disabling search mode will resolve this issue (see "*Inverter Settings*" on page 55).

Searching

When the inverter is in search mode, it may fail to start some loads even though the rated wattage on the load is more than the **Maximum Search Watts** setting. Disable search or apply an additional load (companion load) to make the inverter exit search mode.

Inverter Troubleshooting

To determine the cause of an inverter error condition, refer to the troubleshooting table below for possible solutions.

Table 20 Troubleshooting Common Problems

Problem	Possible cause	Solution(s)
Unit will not power on (no LEDs are on) and the inverter information panel is blank or off.	Unit was turned off using STARTUP/SHUTDOWN button on front panel.	Turn the unit on again.
	DC voltage on the inverter's DC terminals is incorrect.	Check the battery voltage, fuses or breakers and DC cable connections to the inverter. If the DC voltage on the inverter's DC terminals is correct, have unit serviced.
Unit goes into invert mode and starts producing AC output, but stops quickly (several attempts made).	Excessive load on output.	Reduce loads.
	Unit is in over-temperature protection and needs to cool down.	Stop inverting by putting the inverter into Standby mode, and then allow the unit to cool and increase ventilation. If necessary, replace the foam air filter on the bottom of the unit.
	Remote Power Off signal is present.	Release or reset the Remote Power Off switch.
No AC power output. The inverter information panel displays <i>5ch</i> .	Open AC output breakers or fuses and bad output wire connections. Inverter is disabled. Re-enable inverter.	Check the Load AC Voltage status on the Conext Gateway Status page and check AC voltage on the inverter AC Out terminal block. If the Status page shows correct AC voltage but there is no AC voltage on the inverter AC Out terminal block, check for loose connections on the inverter terminal block. If connections are not loose, the inverter may need to be serviced. If there is correct AC voltage on the Status page and on the inverter AC terminal block, check for open AC output breakers or fuses and bad output wire connections. If AC voltage on the Status page or inverter AC terminal block is incorrect, have unit serviced.
No AC power output. INVERT LED is flashing.	AC load too small for search mode circuit to detect.	Reduce Maximum Search Watts setting, increase load above Maximum Search Watts setting, or disable Search on the Setup menu. If the AC1 LED is on, check inverter output connections and voltage.

Problem	Possible cause	Solution(s)
<p>Low AC power output or low surge power. INVERT LED is on.</p> <p>AC inductive loads are not running at full speed.</p>	<p>Insufficient DC current being provided to the inverter to operate the AC loads.</p>	<p>Check the battery voltage, fuses or breakers and cable connections.</p> <p>Make sure the battery bank is sufficient (check for low DC voltage while running the load).</p> <p>Make sure the cable length and size is correct (see the <i>Conext XW Pro Installation Guide</i> for correct cable). Tie the battery cables together to reduce inductance.</p> <p>Apply a load greater than 100 W or disable Power Save (see "<i>Advanced Features</i>" on page 87).</p>
<p>Inverter goes into invert mode and starts producing AC output and then stops or does not start at all.</p>	<p>Maximum Search Watts setting is too low or high.</p> <p>Potential problem loads for search mode:</p> <p>Incandescent lights have a higher starting wattage when the filament is cold than the continuous rating of the bulb.</p> <p>Fluorescent bulbs draw little power until the mercury vapor begins to conduct enough current to light the tube.</p> <p>Other loads: Some appliances draw power even when turned off: TVs with instant-on circuits and VCRs, for example.</p>	<p>If the search sensitivity is set higher than the combined loads, then connect an auxiliary load to bring the inverter out of search mode before the appliances can be turned on.</p> <p>If the sensitivity is set lower than the combination of the loads, the loads will remain on and excess battery drain will occur since the inverter won't ever idle.</p> <p>Another solution is to turn the item off at the wall, use an extension cord with a rocker switch, a switch at the outlet, or an appropriate circuit breaker.</p>
<p>The utility grid is not dropping out, but the unit is disconnecting from the grid.</p>	<p>The AC voltage or frequency provided to the inverter input is outside the AC Setting voltage or frequency range.</p>	<p>Adjust the AC1 voltage and frequency settings (see "<i>AC Settings</i>" on page 73). Raise the high voltage and frequency settings, and lower the low voltage and frequency settings. If Grid support is enabled, these limits are over-ridden by the default anti-islanding AC parameters.</p>

Problem	Possible cause	Solution(s)
<p>The inverter connects to the grid and can charge normally. In a grid interactive mode (Grid Support enabled), the unit is experiencing excessive anti-islanding faults during periods of high sell amperage.</p>	<p>The impedance of the AC connection to the inverter is too high for the power being sold to the grid. The impedance may be on the high end if the installation is too far from the utility point of common connection or if the wires are too small between the Conext XW Pro and the main service panel.</p>	<p>Measure the grid voltage at the service panel (meter base). It is important to measure L1-N, L2-N, L1-L2, and N-Ground. If these measurements are not within the voltage range for sell mode (see <i>"Electrical Specifications" on page 122</i>), contact your utility for resolution. If these measurements are within the voltage range for sell mode (see <i>"Electrical Specifications" on page 122</i>), the most likely event is that the AC wiring between the inverter and the meter base is not sized appropriately. It should be sized for a 1 to 1.5% maximum voltage drop. Alternately, the Max Sell Amps can be reduced until the unit stops disconnecting.</p>

Battery Charger Troubleshooting

To determine the cause of a charger error condition, refer to the troubleshooting solutions below to resolve the situation.

Table 21 Troubleshooting Battery Charger Problems

Problem	Possible Cause	Solution
AC1/AC2 LED is on, but will not start charging (allow 40 seconds to synchronize).	1) Charger is disabled on the Setup menu.	1) Enable the charger.
	2) Charger Block is enabled and the Conext XW Pro is inside of the charger block time window.	2) Disable Charger Block if you need to override this feature.
	3) The Conext XW Pro is load shaving.	3) Check the load shave settings. If the load draw from the grid exceeds Load Shave Amps , the charger will not operate.
	4) Charger is set for 2-stage charging and has completed a full charge cycle.	4) No action required. The charger comes on when the battery reaches the Recharge Volts setting. Otherwise use the Force Charge setting on the device setup menu to force a bulk or float charge.
	5) Battery voltage is below 40 V and AC source could not be qualified.	5) Recharge the batteries with an external battery charger or replace the batteries.
	6) Gen support is enabled and the draw from the loads exceeds the Gen support amps setting.	6) Temporarily disable Gen support mode, or reduce loads below Gen Support Amps setting.
AC1 or AC2 LED is flashing, but will not start charging (allow 40 seconds to synchronize).	AC voltage and frequency at the AC input terminal are within nominal range, but the inverter output is not yet synchronized to the AC source. There are four possible causes: 1) The inverter may already be synchronized to another AC source.	1) The inverter is operating normally.
	2) The AC voltage or frequency applied to the input is outside of the acceptable range of the inverter.	2) Adjust the AC acceptance settings, see " AC Settings " on page 73, or possibly service an unstable generator.
	3) AC voltage and frequency at the AC input terminals are within acceptable range, but the inverter is not yet synchronized to the AC source.	3) For 120 V/240 V units, measure voltage in four places on the input of the inverter: L1-N, L2-N, L1-L2, and N-Ground. These readings must be approximately 120, 120, 240, and 0 respectively. Make sure these readings are within the tolerance for AC acceptance and are stable for at least 60 seconds.

Problem	Possible Cause	Solution
Charger amperage drops off before full charging has finished (no Event LED).	AC frequency at the AC input terminal may be out-of-tolerance (too high or low) or the AC voltage may be outside the Hi AC Volt or Lo AC Volt settings. AC input voltage approaching the low disconnect level.	Check the settings on the AC Settings menu. Check for the correct AC voltage or frequency at the AC input terminal. If the AC source is a generator, adjust the AC voltage or frequency accordingly. Increase the difference between the Hi AC Volt (AC1) and Lo AC Volt (AC1) settings to allow synchronization.
	The charge settings are incorrectly configured for your battery type.	Select the correct battery type or configure a Custom battery type.
	Ambient temperature may be high, causing unit to overheat and ramp down the charging.	Cool the unit down or check for anything preventing air flow around the unit.
	Battery bank has one or more bad cells or inadequate wiring.	Check tightness of battery connections and interconnections. Replace battery.
	Battery Management System on Lithium Ion battery has interrupted charging.	Consult with battery manufacturer for battery compatibility.
Charger stops before full charging (or equalization) has finished. Event LED flashes and AC output drops momentarily.	Cold temperature around batteries with battery temperature sensor (BTS) installed may be causing unit to reach High Batt Cut Out setting.	Disconnect BTS during charging or increase High Batt Cut Out setting.
Charger output is low.	Loose or corroded battery connections.	Check and clean all connections.
	Loose AC input connections.	Check and tighten AC wiring connections.
	Worn out batteries.	Replace batteries.
	Battery cables too small or too long.	Refer to cable and battery recommendations in the <i>Conext XW Pro Installation Guide</i> .
Batteries being charged above the bulk/float settings.	If a BTS (Battery Temperature Sensor) is installed, it may be in a cold area or have fallen off the batteries. Another DC charging source may be on the batteries.	Inspect the BTS. Reduce Battery Temperature Coefficient on Custom Battery Settings menu.
	Battery bank size too small relative to charger output.	Increase battery bank size or decrease max charge rate. Note: To bring batteries that are cold to the correct state of charge may require charging at a higher voltage. This may be normal BTS operation. Unplug the BTS and determine if your voltage returns to the bulk/float voltage.

Faults and Warnings

When a fault or warning message appears on the Conext Gateway device status page, you can acknowledge the message to clear the screen. To acknowledge a fault or warning message, press the Enter button. This action does not clear the fault or warning condition - consult *Table 23 on page 110* and *Table 26 on page 115* for suggested actions after you have acknowledged the message.

Warning Messages

Warning messages appear on the Conext Gateway to alert you to an impending system change. You can access all past warnings for a device in the Conext Gateway web application by navigating to **Events > Historical Events** in the Conext XW Pro status page. Each warning has a time stamp to let you know the date and time that the warning appeared.

If several warning messages occur before you can acknowledge or clear them, they are displayed together on a warning list. This list contains messages from every Xanbus-enabled device, not just the Conext XW Pro. You can select a message and view its details from warning list.

Warning Types

There are two types of warnings: automatic and manual. When the Conext XW Pro detects a warning condition, it displays a warning message on the Conext Gateway web application. *Table 22* describes how their behavior differs and how you can respond to them.

Table 22 Warning Types and Behavior

Warning type	Behavior
Automatic warning	Clear automatically if the warning condition that generated the message goes away. You can also acknowledge automatic warnings without waiting for them to clear automatically.
Manual warning	Require you to clear them manually via the Conext Gateway web application before you can proceed with configuring or operating the Conext XW Pro.

Table 23 provides descriptions of the warning messages and solutions.

Table 23 Warning Messages

Warning Number	Message Name	Warning Type	Cause	Solution
w44	Battery Over Temperature	Automatic	Battery Over Temperature Warning. Battery temperature is over 50 °C (122 °F).	Check battery voltage and battery cable connections. Stop charging, if necessary. Check for excessive ambient temperature and adequate ventilation in the battery compartment

Warning Number	Message Name	Warning Type	Cause	Solution
w45	Capacitor over temperature	Automatic	DC Bulk Capacitor over temperature (100 °C/212 °F)	Ensure adequate ventilation around the Conext XW Pro. Reduce the AC loads.
w48	DC Under Voltage	Automatic	Battery voltage is below 47 V.	Check for the correct battery voltage at the inverter's DC input terminals. Check for an external DC load on the batteries. Check condition of batteries and recharge if possible or reduce your Low Batt Cut Out setting.
w49	DC Over Voltage	Automatic	Battery voltage goes within the [High Batt Cut Out - 2V] threshold.	Turn off or check additional charging sources to batteries. Check battery cables. Check for the correct battery voltage at the inverter's DC input terminals. Ensure your DC source is regulated below your high battery cut out or increase your High Batt Cut Out setting.
w57	FET1 Over Temperature	Automatic	Internal temperature is over 85 °C (185 °F). AC input voltage may be too high while charging.	Check for high input AC voltage.
			Operating too large of a load for too long while inverting.	Remove excessive loads.
			Ambient temperature may be high.	Let inverter cool down and try restarting.
			Inverter cooling fan may have failed.	Hold a piece of paper to inverter vents to check the fan. If the fan has failed, have the inverter serviced.
			Inverter airflow intake may be blocked.	Increase clearance around the inverter or unclog the fan air intake.
			Charging setting is too high based on ambient temperature around inverter.	Lower the Max Charge Rate setting.
w58	FET2 Over Temperature	Automatic	See w57.	See w57.
w63	AC Overload	Automatic	Excessive load on the AC output.	Check for loads above the inverter's capacity. Turn off some loads if necessary.

Warning Number	Message Name	Warning Type	Cause	Solution
w64	AC Overload	Automatic	See w63.	See w63.
w68	Transformer Over Temperature	Automatic	See w57.	See w57.
w90	BMS Status Lost	Automatic	BMS Status from the Conext Gateway is not being received.	Verify connectivity between BMS, Conext Gateway, and Conext XW Pro. Verify Battery Type and Charge Cycle settings appropriate for the application.
w92	Conext Gateway Comms Lost	Automatic	Conext XW Pro has lost communication with the Conext Gateway.	Verify connectivity with Conext Gateway.
w93	SunSpec Controller Comms Lost	Automatic	Conext XW Pro has lost communication with the SunSpec Controller.	Verify connectivity of Conext Gateway with SunSpec Controller. If no SunSpec Controller exists on the network, refer to the Conext Gateway Owner's Guide (975-0806-01-03).
w94	Remote Power Off	Automatic	The unit has been turned off with a Remote Power Off switch.	No action required. The unit stops inverting or charging immediately, and shuts down after five seconds. If the unit is configured as a master, it signals other network devices to also shut down.
w95	Equalize Abort	Manual	Equalization terminated abnormally because of interrupted AC input.	Wait until AC input (utility grid) returns to in-tolerance condition.
w96	Cannot Equalize	Manual	The selected battery type should not be equalized.	Change battery type if your batteries should be equalized. Gel or AGM batteries should not be equalized.
			AC input is not qualified or the charge setting is not adequate.	Check for presence of AC. Make sure Charge and Equalize are enabled. Verify the Conext AGS trigger is set to Stop Float . If Stop Voltage is enabled, then the voltage level should be above the Equalize Voltage Setpoint level.
w97	Battery temperature sensor failure	Automatic	Battery Temperature Sensor Shorted	Replace battery temperature sensor.
w500	Lost network connection	Automatic	Lost network connection	Check network cables.

Warning Number	Message Name	Warning Type	Cause	Solution
w501	Inv/Chg is trying to fix a memory problem	Manual	Non-volatile memory warning	Normal operation may return or may go to fault. Turn Conext XW Pro off and on to resume normal operation.

Fault Messages

When the Conext XW Pro detects a fault condition, the fault is displayed within the the Conext Gateway web application. The Conext XW Pro also illuminates the Event/Warning LED on the inverter information panel. A fault affects the operation of the unit. See *Table 24 on page 113* for an explanation of the different fault types.

You can access all past fault messages for a device in the Conext Gateway web application by navigating to **Events > Historical Events** in the Conext XW Pro status page.

Fault Types

There are three types of fault messages: automatic faults, manual faults, and escalating automatic faults. *Table 24* describes how they differ in their behavior and how you can respond to them when they appear on the Conext Gateway.

Table 24 Fault Types and Behaviors

Fault type	Behavior
Automatic faults	Clear automatically if the fault condition that generated the message goes away. You can also acknowledge automatic faults without waiting for them to clear automatically. It is not possible to clear a fault if the cause of the fault is still present.
Manual faults	Require you to clear them by: <ul style="list-style-type: none"> ■ selecting Clear Faults on the Main Conext XW Pro menu or on the menu for the Xanbus-enabled device that generated the fault (if the fault condition still exists, the fault message reappears). ■ correcting the condition that caused the fault.
Escalating automatic faults	Clear automatically if the fault condition goes away, just like an automatic fault. However, if an escalating automatic fault occurs several times within a defined time period, the escalating automatic fault becomes a manual fault, requiring user intervention. For example, if an AC Overload fault occurs three times in five minutes, it will no longer clear itself and become a manual fault. Then you must identify the problem, correct the fault condition, and clear the fault.

Inverter Operation After Faults

Conext XW Pro operation changes when a fault occurs. How the operation changes depends on the operating state of the unit when the fault occurred—inverting, charging, grid or generator support, AC bypass, and so on—and on which fault has occurred.

Table 25 Inverter Operation After Faults

Faults	State when Faults Occur	Action After Faults
F1, F2: AC Output	Inverting	Unit stops inverting and waits for nominal AC output voltage level, or a manual clear from user.
F17 to F22: Relay Welded	Inverting	Unit stops inverting and waits for user to clear fault.
F23 to F40: Anti-Islanding	Grid Support (Peak Load Shaving or Selling)	Unit moves to AC bypass and waits for nominal grid conditions to return for a minimum of five minutes.
F41, F42: Aux power supply voltage	Unit has qualified AC input.	Unit shuts down and waits for nominal AC output voltage level, or a manual clear from user.
F44: Battery Over Temp F45: Capacitor Over Temp	Any state.	If inverting, the unit shuts down and waits for the temperature to return to nominal value. If in any of the AC-interactive states (charging, peak load shaving, sell, gen support), the unit goes into AC bypass mode until the temperature returns to the nominal value. If the unit is not in AC bypass, it shuts down until the temperature returns to nominal value. After these faults clear, the unit returns to its previous operating state.
F47 to F49: DC Under Voltage and Over Voltage	Unit is inverting or has qualified AC input and is preparing to charge.	If inverting, the unit shuts down and waits for nominal voltage. If operating with a qualified AC source, the unit charges if charging is enabled, or remains in AC bypass if charging is disabled.
F63 to F65: AC Overload	Inverting or Grid Support	Unit stops inverting and waits to qualify AC. Unit waits for user to manually clear fault.

Table 26 provides descriptions of the fault messages and solutions. If you are unable to resolve the problem after referring to this table, contact your dealer or Customer Service.

Table 26 Fault Messages

Fault Number	Message	Fault Type	Cause	Solution
F1	AC Output Under Voltage	Escalating Auto Fault. Must occur 3 times in 2 minutes before becoming a manual fault.	AC under voltage shutdown at 108 V. The inverter has shut down to protect the loads.	Clear the fault and attempt restart. If problem persists, call customer service.
F2	AC Output Over Voltage	Escalating Auto Fault. Must occur 3 times in 30 seconds before becoming a manual fault.	AC over voltage shutdown at 135 V. The inverter has shut down to protect the loads.	Clear the fault and attempt restart. If problem persists, call customer service.
F17	Relay(s) Welded	Manual	The AC1 L1 transfer relay is bad or an AC source was wired directly to the AC output.	Disconnect the inverter's output wiring. If error continues, have unit serviced.
F18	Relay(s) Welded	Manual	The AC1 L2 transfer relay is bad or an AC source was wired directly to the AC output.	Disconnect the inverter's output wiring. If error continues, have unit serviced.
F19	Relay(s) Welded	Manual	The AC2 L1 transfer relay is bad or an AC source was wired directly to the AC output.	Disconnect the inverter's output wiring. If error continues, have unit serviced.
F20	Relay(s) Welded	Manual	The AC2 L2 transfer relay is bad or an AC source was wired directly to the AC output.	Disconnect the inverter's output wiring. If error continues, have unit serviced.
F21	Relay(s) Welded	Manual	An unidentified transfer relay is bad or an AC source was wired directly to the AC output.	Disconnect the inverter's output wiring. If error continues, have unit serviced.
F22	Relay(s) Welded	Manual	An unidentified L1 transfer relay is bad or an AC source was wired directly to the AC output.	Disconnect the inverter's output wiring. If error continues, have unit serviced.
F23	AI Over Frequency	Automatic	Over-frequency anti-islanding, caught by the AC qualification limit.	No action required. The inverter stops selling and disconnects from the grid. When the fault clears, a five-minute timer begins counting down. The inverter does not sell again until grid voltage and frequency are within range for five minutes.

Fault Number	Message	Fault Type	Cause	Solution
F24	AI Under Frequency	Automatic	Under-frequency anti-islanding, caught by the AC qualification limit.	See F23 .
F25	AI Over Frequency	Automatic	Over-frequency anti-islanding.	See F23 .
F26	AI Under Frequency	Automatic	Under-frequency anti-islanding.	See F23 .
F27	AI L1 Over Voltage	Automatic	Over-voltage anti-islanding, fast disconnect, 135 VAC.	See F23 .
F28	AI L2 Over Voltage	Automatic	See F27 .	See F23 .
F29	AI L1L2 Over Voltage	Automatic	Over-voltage anti-islanding fault, caught by the qualification limit, voltage difference between L1 and L2.	See F23 .
F30	AI L1L2 Over Voltage	Automatic	Over-voltage anti-islanding, fast disconnect, 270 V.	See F23 .
F31	AI L1 Over Voltage	Automatic	Over-voltage anti-islanding, slow disconnect, 130 V.	See F23 .
F32	AI L2 Over Voltage	Automatic	Over-voltage anti-islanding, slow disconnect, 130 V.	See F23 .
F33	AI L1L2 Over Voltage	Automatic	Over-voltage anti-islanding, slow disconnect, 260 V.	See F23 .
F34	AI L1 Under Voltage	Automatic	Under-voltage anti-islanding, slow disconnect, 108 V.	See F23 .
F35	AI L2 Under Voltage	Automatic	See F34 .	See F23 .
F36	AI L1L2 Under Voltage	Automatic	See F34 .	See F23 .
F37	AI L1 Under Voltage	Automatic	Under-voltage anti-islanding, fast disconnect, 66 VAC.	See F23 .
F38	AI L2 Under Voltage	Automatic	See F37 .	See F23 .
F39	AI L1L2 Under Voltage	Automatic	Under-voltage anti-islanding fault, caught by the qualification limit, voltage difference between L1 and L2.	See F23 .
F40	AI L1L2 Under Voltage	Automatic	Under-voltage anti-islanding, fast disconnect, 132 V.	See F23 .

Fault Number	Message	Fault Type	Cause	Solution
F41	APS Under Voltage	Escalating Auto Fault. Must occur 3 times in 30 seconds before becoming a manual fault.	Auxiliary power supply under-voltage shutdown	Clear the fault and attempt restart. If problem persists, call customer service.
F42	APS Over Voltage	Escalating Auto Fault. Must occur 3 times in 30 seconds before becoming a manual fault.	Auxiliary power supply over-voltage shutdown	Clear the fault and attempt restart. If problem persists, call customer service.
F44	Battery Over Temperature	Automatic	Battery over- temperature shutdown at 60 °C.	<p>Clear the fault and attempt restart. Stop charging, check battery voltage and temperature. Check for excessive ambient temperature and adequate ventilation in the battery compartment.</p> <p>Note: Shutdown temperature is above 60 °C. Recovery occurs at 50 °C where the Conext XW Pro will be enabled again.</p>
F45	Capacitor Over Temperature	Automatic	Capacitor over-temperature shutdown at 105 °C.	Clear the fault and attempt restart. Ensure adequate ventilation around the Conext XW Pro. Reduce AC loads.
F46	Controller fault	Manual	Controller fault	Service required.
F47	DC Under Voltage	Automatic	DC under-voltage shutdown (immediate) occurs if DC voltage is below 32 V. The fault clears and the inverter restarts when DC voltage reaches V+4 V.	Check for the correct battery voltage at the inverter's DC input terminals. Check for an external DC load on the batteries. Check condition of batteries and recharge if possible.
F48	DC Under Voltage	Automatic	DC under-voltage shutdown occurs if DC voltage is below voltage level.	See F47.

Fault Number	Message	Fault Type	Cause	Solution
F49	DC Over Voltage	Escalating Auto Fault.	<p>DC over-voltage shutdown. Occurs if DC voltage goes over the High Batt Cut Out setting.</p> <p>The fault can also occur when batteries are disconnected at the DC breaker while the Conext XW Pro is operating.</p>	<p>Clear the fault and attempt restart. Ensure battery voltage is below 58 VDC at Conext XW Pro terminals. Check all other charging source outputs, battery cables. Ensure that batteries are connected, or that your DC source is regulated below your high battery cut out or increase your Hi Batt Cut Out setting.</p>
F52	EEPROM Error	Manual		No action. Clear fault and resume operating or configuring the unit. If the fault persists, have the unit serviced.
F53	EEPROM Error	Manual		See F52.
F54	EEPROM Error	Manual		See F52.
F55	EEPROM Error	Manual		See F52.
F56	EEPROM Error	Manual		See F52.
F57	FET1 Over Temperature Shutdown	Automatic	Internal temperature is over 105 °C.	Fault clears when temperature drops to 75 °C.
			AC input voltage may be too high while charging.	Check for high input AC voltage.
			Operating too large of a load for too long while inverting.	Remove excessive loads.
			Ambient temperature may be high.	Let inverter cool down and try restarting.
			Inverter cooling fan may have failed.	Hold a piece of paper to inverter vents to check the fan. If the fan has failed, have the inverter serviced.
			Inverter airflow intake may be blocked.	Increase clearance around the inverter or unclog the fan air intake.
			Charging setting is too high based on ambient temperature around inverter.	Lower the Max Charge Rate setting.
F58	FET2 Over Temperature Shutdown	Automatic	See F57.	See F57.
F59	GOCFG process failed	Manual	Auto-configuration process failed.	Retry the "Copy From" procedure, or configure the unit manually.

Fault Number	Message	Fault Type	Cause	Solution
F63	AC Overload	Escalating Auto Fault. Must occur 3 times in 5 minutes before becoming a manual fault.	Excessive load on the AC output.	Check for loads above the inverter's capacity. Turn off some loads if necessary. To clear the fault: Turn off the unit by holding the power button for 5 sec. Disconnect the Conext XW Pro from the battery bank for 20 sec.
F64	AC Overload L1	Escalating Auto Fault. Must occur 3 times in 5 minutes before becoming a manual fault.	Excessive load on the AC output.	See F63
F65	AC Overload L2	Escalating Auto Fault. Must occur 3 times in 5 minutes before becoming a manual fault.	Excessive load on the AC output.	See F63.
F66	System Configuration Fault	Automatic	Multi-Unit Configuration settings are incorrect.	Ensure only one unit is configured as the master. Ensure each unit has a unique Device Number, and that connections have been configured correctly. Ensure there is only one primary charger.
F67	Watchdog Error	Manual		Service required.
F68	Transformer Over Temperature	Automatic	The transformer temperature is over 140 °C.	The fault clears when the transformer temperature falls to 125 °C. Ensure adequate ventilation around the Conext XW Pro. Reduce AC loads.
F69	External Sync Failed	Manual		Check connections and cable on external AC sync port. In a single-inverter system, nothing must be plugged into the AC sync port. Clear fault and try again. If these steps fail, the unit requires service.
F71	Battery Discharge Over Current	Manual	There is an excessive load on the Li-Ion battery. (The fault applies only to Li-Ion batteries).	Change the default threshold of the max battery discharge current limit or reduce the load.

Fault Number	Message	Fault Type	Cause	Solution
F72	External AC Contactor Malfunction	Manual	The External AC Contactor was not set as expected.	Check why the AC contactor has failed. Check for fusing of coil, wiring and connections. Verify that the AC contactor has power.
F73	Battery Charge Over Current	Manual	Charge current exceeded the BMS limits (this fault applies only to Li-Ion batteries).	Change the default threshold of the max. battery charge current limit and clear the fault. If problem persists, call customer service.
F74	Battery Under Voltage	Manual	DC bus voltage is below BMS reference discharge voltage.	Verify DC bus for secure connectivity and confirm battery output voltage is above BMS discharge reference voltage.
F75	Battery Over Voltage	Manual	DC bus voltage exceeds BMS charge reference voltage.	Verify battery pack voltage does not exceed BMS limits + configured offset. If problem persists, call customer service.
F76	External Battery Stop Command	Automatic	Battery charging and discharging stopped due to external command.	Inspect battery pack or other external control devices for conditions that may prompt it to send a stop command. Configure to warning-only if required.
F90	BMS Status Lost	Automatic	BMS Status from the Conext Gateway is not being received	Verify connectivity between external BMS or Battery Monitor, Conext Gateway and Conext XW Pro. Verify Battery Type and Charge Cycle settings appropriate for the application.
F91	SOC Level Lost	Automatic	Conext Gateway is not receiving SOC data from the external BMS or Battery Monitor, and so cannot relay to Conext XW Pro.	Verify connectivity between external BMS or Battery Monitor, Conext Gateway and Conext XW Pro. If an external BMS or Battery Monitor does not exist in the application, disable State of Charge Control.
F92	Gateway Comms Lost	Automatic	see W92	see W92
F93	SunSpec Controller Comms Lost	Automatic	see W93	see W93
F500	Silicon Serial ID Failure	Manual	Silicon Serial ID Failure	Service required.

6 Specifications

What's in This Chapter?

Electrical Specifications	122
Mechanical Specifications	123
Conext XW Pro Overload Capability	125
Output Power Versus Ambient Temperature	127
Conext XW Pro Efficiency	128
Regulatory Approvals	129
Grid Support Utility Interactive Functions	130
California Rule 21: Smart Inverter Grid-Support Utility Interactive Functions	130
Hawaiian Electric Company (HECO) Rule No. 14: Smart Inverter Grid-Support Utility Interactive Functions	142
IEEE 1547-2003 Standard for Interconnecting Distributed Resources with Electric Power System (60Hz and 50Hz)	156
Puerto Rico Energy Power Authority (PREPA) Technical Requirements for Interconnecting Wind and Solar Generation	170

This chapter provides the electrical and mechanical specifications for the Conext XW Pro.

DISCLAIMER REGARDING STATUS DATA

Status data reported by the Conext XW Pro are approximate values intended to provide general and non-exact information about the Conext XW Pro. Under no circumstances should this status data be used for precise evaluation of the Conext XW Pro system performance, including efficiency considerations. In systems with a single Conext XW Pro, the measurement capabilities of the inverter/charger allow for deviations of up to 5% of actual values. In systems with multiple inverter/charger units, the compounded effect of accuracy deviations in the status data could result in aggregated deviations exceeding 5% of actual values. For systems requiring higher accuracy status reporting of ac parameters, Schneider Electric recommends the use of external monitoring equipment of appropriate and accurate calibration. For higher accuracy measurement of dc (battery) parameters, Schneider Electric recommends installing an appropriate dc battery monitor in the system.

Electrical Specifications

NOTE: Specifications are subject to change without prior notice.

Table 27 Conext XW Pro Electrical Specifications

Specification	XW Pro 6848 NA
Continuous Output Power (Inverter Mode @ 25°C)	6,800 W
Continuous Output Power (Inverter Mode @ 40°C)	6,000 W
Surge Rating (Overload for 1 minute)	12,000 W
Surge Rating (Overload for 30 minutes)	8,500 W
Waveform	True Sine Wave
Idle Consumption - Inverter Mode, no load	28 W
Idle Consumption - Search Mode	< 8 W
DC Input Voltage Range	40 - 64 VDC, 48 VDC nominal
DC Current at Rated Continuous Power (Inverter Mode)	180 A
Maximum Charge Rate (Charger Mode)	140 A
Power Factor Corrected Charging	PF 0.98
Compatible Battery Types	Flooded (default), Gel, AGM, Lithium ion, custom
Battery Bank Range	440 - 10,000 Ah
AC Output Voltage	120/240 V ± 3%
AC Continuous Output Current (Inverter Mode)	L-L: 28 A (120/240 V)
AC Continuous Output Current, Imbalanced line loading on L1-N or L2-N (Inverter Mode)	L-N: 40 A (120 V)

Specification	XW Pro 6848 NA
Surge Current (Inverter Mode)	52 A _{RMS} for 60 seconds (240 V nominal)
AC Input Voltage Range (Bypass/Charger Mode)	160-270 VAC (240 V nominal)
AC Input Frequency Range (Bypass/Charger Mode)	52-68 Hz (default) 44-70 Hz (allowable)
AC Input Maximum Breaker Capacity	60 A maximum, double-pole
AC Output Maximum Breaker Capacity	60 A maximum, double-pole
AC1 (Grid) Input Current	3 - 60 A
AC2 (Generator) Input Current	3 - 60 A
AC Output Frequency	60.0 ± 0.1 Hz
Total Harmonic Distortion	< 5% at rated power
Automatic Transfer Relay Capacity & Typical Transfer Time	60 A / 8 ms
Auxiliary Relay Output	0 - 12 VDC, Maximum 250 mA
Grid Sell Current (Selectable Limit)	0 - 27 A _{RMS} (240 V nominal)
Grid Sell Power	6,000 W
Peak Efficiency	95.1%
CEC Weighted Efficiency	93.0%

Mechanical Specifications

NOTE: Specifications are subject to change without prior notice.

Table 28 Conext XW Pro Mechanical Specifications

Model	XW Pro 6848 NA
Non-Volatile Memory	Yes
Inverter Information Panel	Status LEDs indicate AC In status, events/warnings, equalize mode, battery level. 3-character display indicates output power or charge current, event/warning codes. STARTUP/SHUTDOWN and equalize button
Multiple Unit Configurations	Up to 3 parallel units in 120/240 three-wire configuration. Electrically, up to 4 parallel units can be connected and operated.

Model	XW Pro 6848 NA
System Network	Conext Xanbus™ (publish-subscribe network, no need for hubs or special cards)
Emissions	FCC Part 15, Class B Industry Canada ICES-003 Issue 5, Class B
Regulatory approvals	CSA C22.2 No. 107.1-01 - General Use Power Supplies UL 1741 - 2nd Ed - Inverters, Converters, Controllers and Interconnection System Equipment California tariff Rule 21-compliant and certified to UL1741SA
Enclosure Type	NEMA Type 1—Indoor
Rated Temperature Range (meets specifications)	32–77 °F (0–25 °C)
Operational Temperature Range	-13–158 °F (-25–70 °C)
Storage Temperature Range	-40–185 °F (-40–85 °C)
Inverter Dimensions (H × W × D)	23 × 16 × 9" (580 × 410 × 230 mm)
Shipping Dimensions (H × W × D)	28 × 22 ½ × 15 ½" (711 × 572 × 394 mm)
Inverter Weight	125 lb (57 kg)
Shipping Weight	132 lb (60 kg)
Storage Temperature Range	-40–185 °F (-40–85 °C)

Figure 26 Conext XW Pro Block Diagram

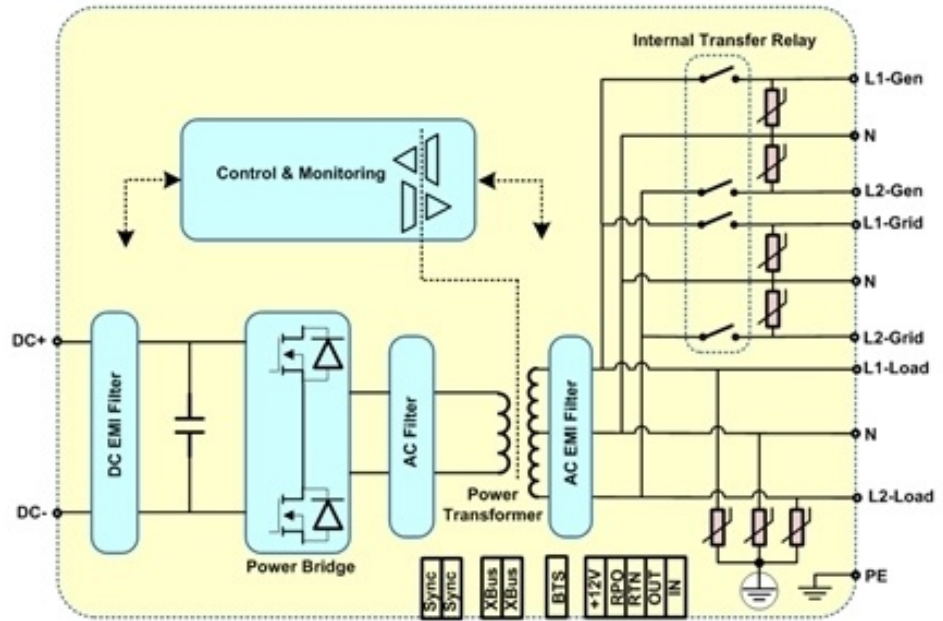

Conext XW Pro Overload Capability

Loads connected to the inverter are seldom constant, and large loads are often operated for short periods. To accommodate larger loads, the Conext XW Pro can temporarily exceed its continuous output power rating.

The graphs below illustrate approximate operation time versus load. Inverter operation time during overload is limited by both inverter internal temperature protection and by the product of AC output current and elapsed time.

Figure 27 AC Overload Capability

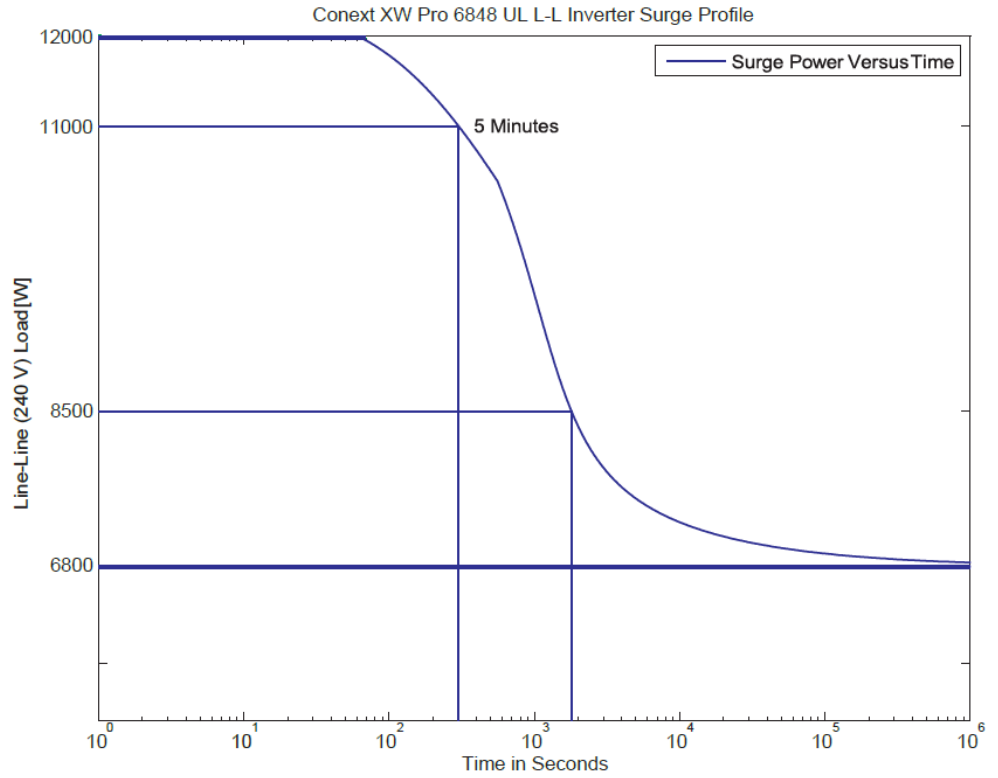
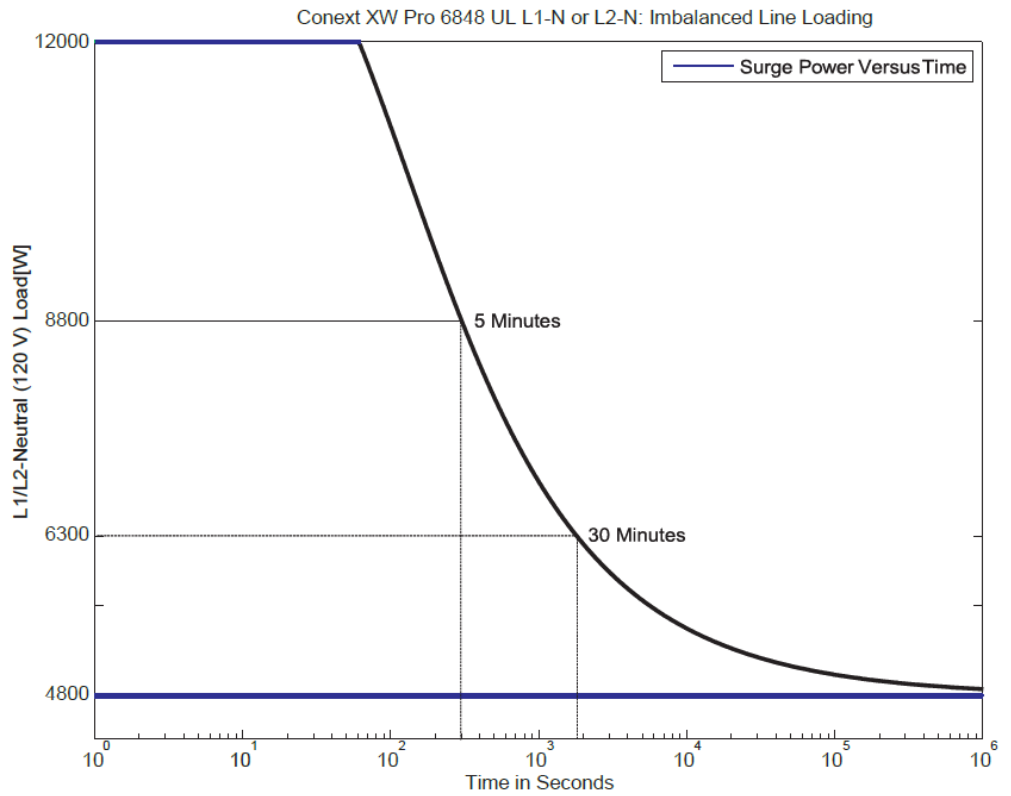

Figure 28 AC Overload Capability



Output Power Versus Ambient Temperature

For the Conext XW Pro 6848 model, the power can be limited by the installed DC and AC breakers. For example, at 8500 W the DC or AC breakers may disconnect before the 30 minute rating.

When the internal temperature of the Conext XW Pro exceeds a preset limit, it begins to limit output power automatically to stop maximum internal temperatures being exceeded.

Figure 29 Output Power Versus Ambient Temperature

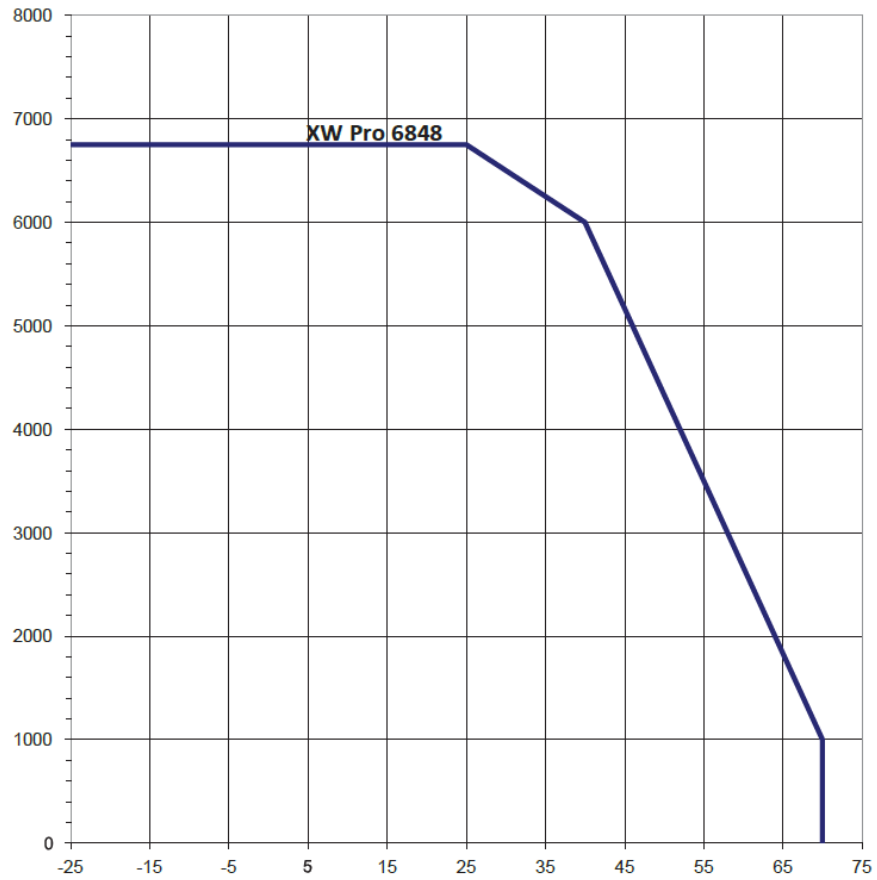

Conext XW Pro Efficiency

Inverting Efficiency (Typical)

Figure 30 Inverting Efficiency (typical)

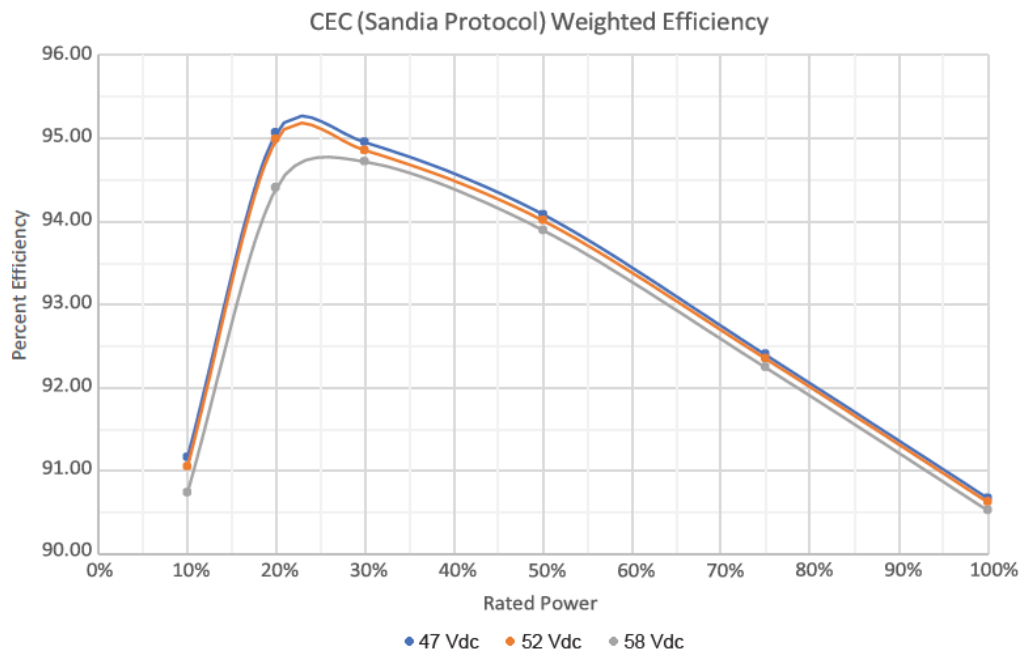

Charging Efficiency (Typical)

Figure 31 Charging Efficiency (typical)

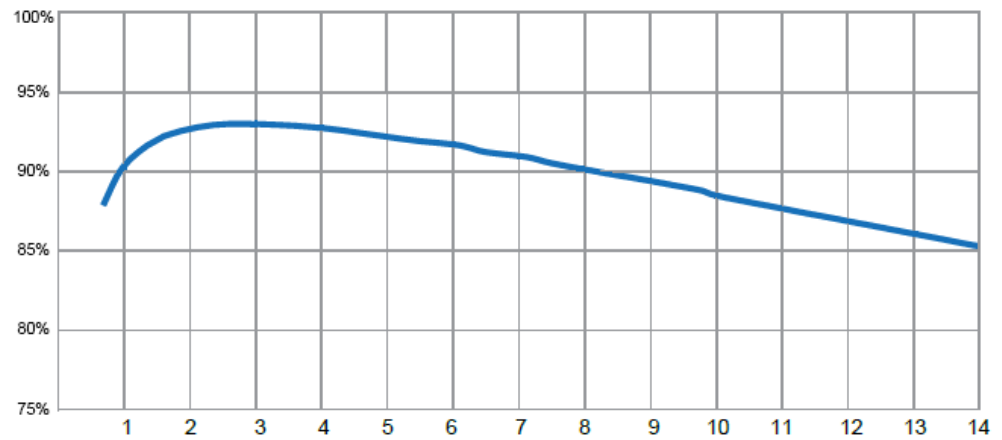

Maximum Charging Current

Figure 32 Charging Current

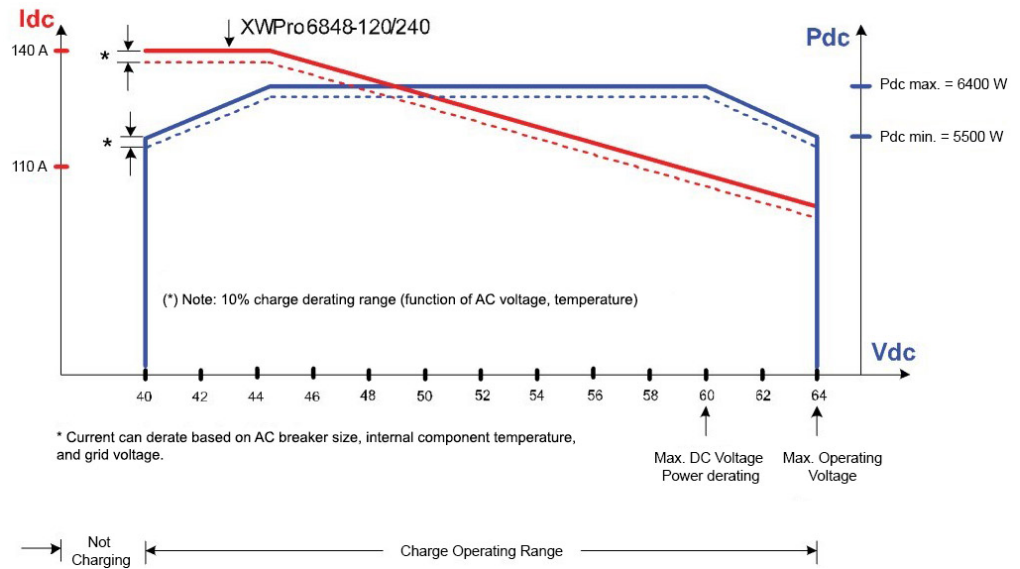

Regulatory Approvals

Electromagnetic Compatibility

The Conext XW Pro inverter complies with emission limits specified in:

- FCC Part 15B Class B limits
- Industry Canada ICES-003 Class B limits

Utility Interactive

Conext XW Pro inverter qualifies as a Smart Inverter¹ and complies with multiple jurisdictions grid interconnection standard requirements that are currently in effect in different jurisdictions:

- UL1741, 2nd Edition -2018 ("UL1741SA")
- CSA 107.1-2016
- IEEE 1547-2003 Standard for Interconnecting DER with Electric Power Systems
- IEEE 1547.1-2005
- IEEE 1547a-2014 (Amd 1)
- California Rule 21

¹ A Smart Inverter is a Distributed Energy Resource (DER) that autonomously performs functions that minimize the risk of unstable grid operations by providing dynamic active and reactive power support, voltage and frequency ride-through, ramp-rate control and other functions.

- Hawaiian Electric Company (HECO)
- Puerto Rico Energy Power Authority (PREPA)

Grid Support Utility Interactive Functions

These Grid Support Utility Interactive Functions are included in the Conext XW Pro inverter:

- Anti-Islanding
- Voltage Ride-Through (L/HVRT) and disconnection
- Frequency Ride-Through (L/HFRT) and disconnection
 - Available for HECO settings and modified Molokai and Lanai ride through and disconnect settings as well.
- Volt-Var Q(V)
- Soft Start (SS)
- Ramp Rate (RR)
- Fixed Power Factor (FPF)
- Frequency-Watt P(f)
- Volt-Watt P(V)
- TROV
- Voltage and Frequency Reconnection

California Rule 21: Smart Inverter Grid-Support Utility Interactive Functions

Q(V) Volt-VAr Function

When the Q(V) Volt-VAr function is enabled, the Conext XW Pro is in Grid Support mode. Reactive power output is actively control as a function of the voltage following the Volt-VAr piecewise linear characteristic in the figure below.

- The Conext XW Pro dynamically injects reactive power into the grid following the P1P2 segment when AC voltage trends lower than the nominal value.
- The Conext XW Pro dynamically absorbs reactive power from the utility grid following the P5P6 segment when AC voltage trends higher than the nominal value.
- By generating or consuming reactive power in response to grid voltage fluctuations, Conext XW Pro contributes to grid stabilization towards the nominal voltage.

The Q(V) function is enabled by default.

Figure 33 Q(V) Volt-Var Function

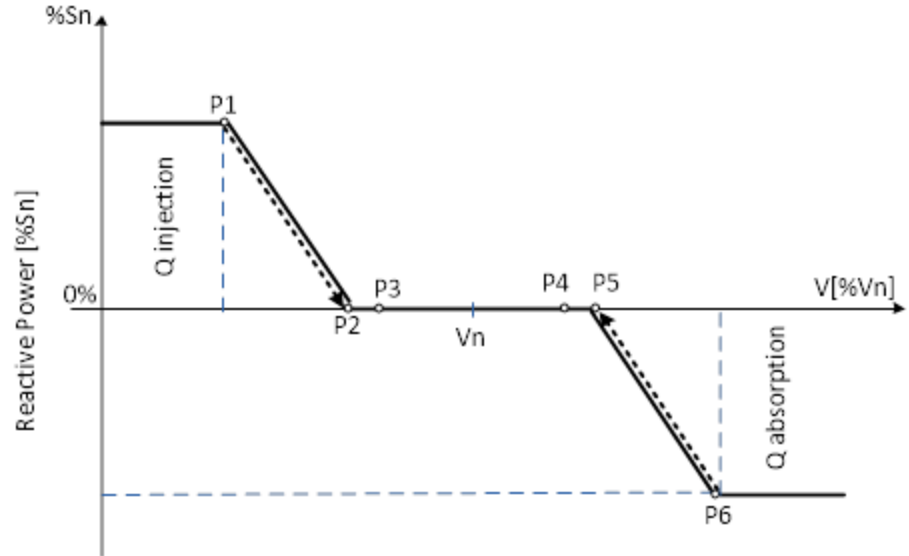

Q – The Conext XW Pro output reactive power in percentage of nominal rated apparent power S_n .

For example, $Q_1 = 30\%$ means $Q_1 = 1800 \text{ VAR}$ for $S_n = 6000 \text{ kVA}$ of the Conext XW Pro nominal rated apparent power.

V - Utility grid voltage in percentage) of nominal voltage V_n

For example, $V_1 = 92\%$ means $V_1 = 221 \text{ V}$ for 240 V nominal grid.

Table 29 Rule 21 Q(V) Volt-Var function default and adjustability range settings

Parameter	Voltage [%Vn]		Reactive Power [%Sn]	
	Default	Range	Default	Range
Point P1	92	85 to 98.75	30	+15 to +60
Point P2	96.7	90 to 100	0	0
Point P3	97	90 to 100	0	0
Point P4	103	100 to 110	0	0
Point P5	103.3	100 to 110	0	0
Point P6	107	101.25 to 112.5	-30	-60 to -15

The Reactive Power Volt-Var function has priority over generated active power. The Conext XW Pro may need to reduce produced active power to meet the reactive power demand.

Fixed Power Factor Function

This function allows the user to set the Conext XW Pro output Power Factor in Grid Support Mode.

- The Power Factor (PF) is controllable from 20% to 100% nominal output power and default setting is PF = 0.95 leading.

- Power Factor setting adjustability range from - 0.85 lagging to 0.85 leading (EEI² Power Factor sign convention).
- When enabled, the PF setting has priority over other functions, which means that active power may be reduced to achieve the power factor setpoint.

The Fixed Power Factor function is disabled by default.

Figure 34 Fixed Power Factor function

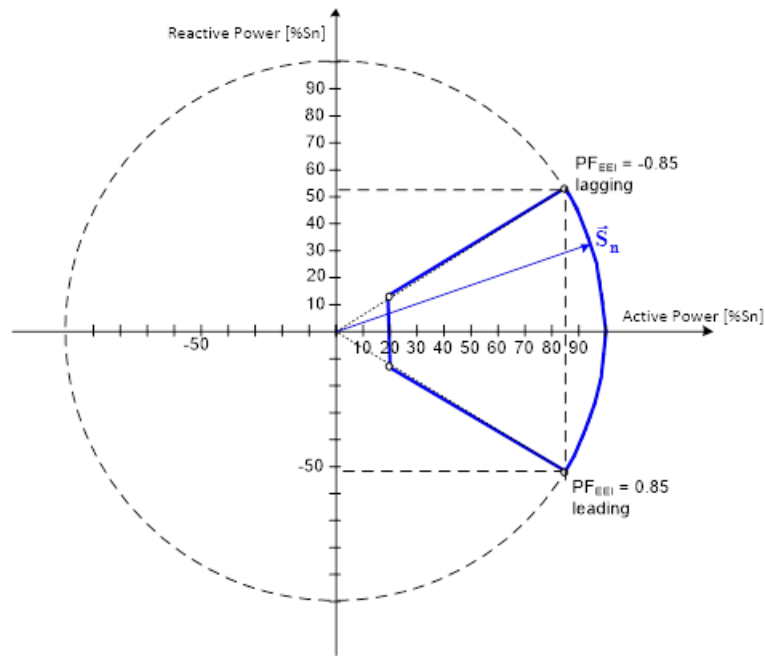

Table 30 Rule 21 Fixed Power Factor Function default and adjustability range settings

Parameter	Default	Range	Observations
Power Factor	0.95 leading	1	EEI Generator reference frame convention ²
		(-0.85 to -0.99) lagging	
		(0.85 to 0.99) leading	

²EEI – Edison Electric Institute

P(V) Volt-Watt Function

When the Conext XW Pro is in Grid Support mode and P(V) function is enabled:

- The Conext XW Pro dynamically increases the active power injected into the utility grid from the pre-disturbance level when AC voltage trends lower than V2, following the P1P2 segment in the figure below.
- The Conext XW Pro dynamically curtails active power injected into the utility grid from the pre-disturbance level when AC voltage trends higher than V5, following P5P6 segment in the figure below.
- By adjusting the active power in response to grid voltage fluctuations, Conext XW Pro contributes to grid stabilization towards the nominal value.

The P(V) function is enabled by default.

Figure 35 P(V) Volt-Watt Function

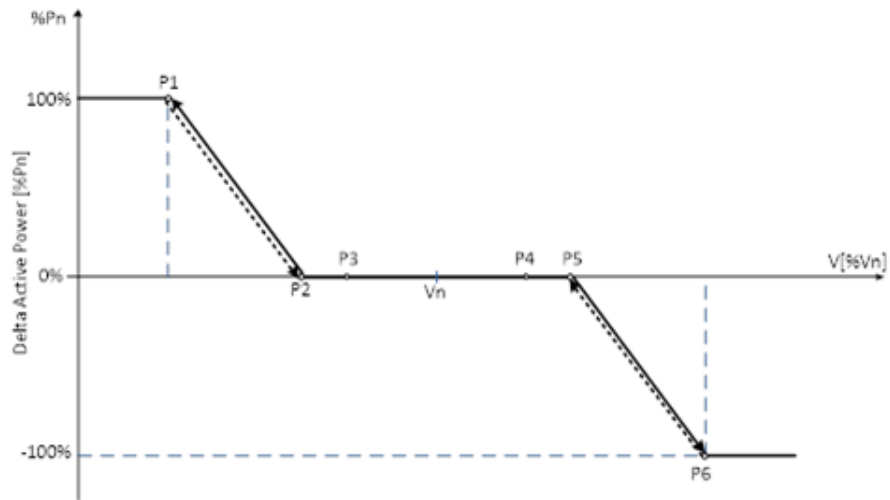

P – The Conext XW Pro output active power in percentage of nominal rated active power Pn.

V - Utility grid voltage in percentage) of nominal voltage Vn [%Vn]

For example, V1 = 90% means V1=216 V for Vn = 240 V nominal grid.

Table 31 Rule 21 P(V) Volt-Watt function default and adjustability range settings

Parameter	Voltage [% Vn]		Active Power [%Pn]	
	Default	Range	Default	Range
Point P1	90	85 to 99	100	0 to 100
Point P2	94	90 to 99	0	0
Point P3	95	90 to 100	0	0
Point P4	105	100 to 110	0	0
Point P5	106	101 to 110	0	0
Point P6	110	101 to 115	-100	-100 to 0

NOTE: If both P(V) and P(f) are active, the lesser of the two power levels will take precedence (i.e. the curve that is curtailing the active power the most will set the output power level).

P(f) Frequency-Watt Function

When the Conext XW Pro is in Grid Support mode and P(f) function is enabled:

- The Conext XW Pro dynamically increases the active power injected into the grid from the pre-disturbance level when AC frequency trends lower than f_2 , following the P1P2 segment in the figure below.
- The Conext XW Pro dynamically curtails active power injected into utility grid from the pre-disturbance level when AC frequency trends higher than f_5 following the P5P6 segment in the figure below.
- By adjusting the active power in response to grid frequency fluctuations, Conext XW Pro contributes to grid stabilization towards the nominal value.

The P(f) function is enabled by default.

Figure 36 P(f) Frequency-Watt Function

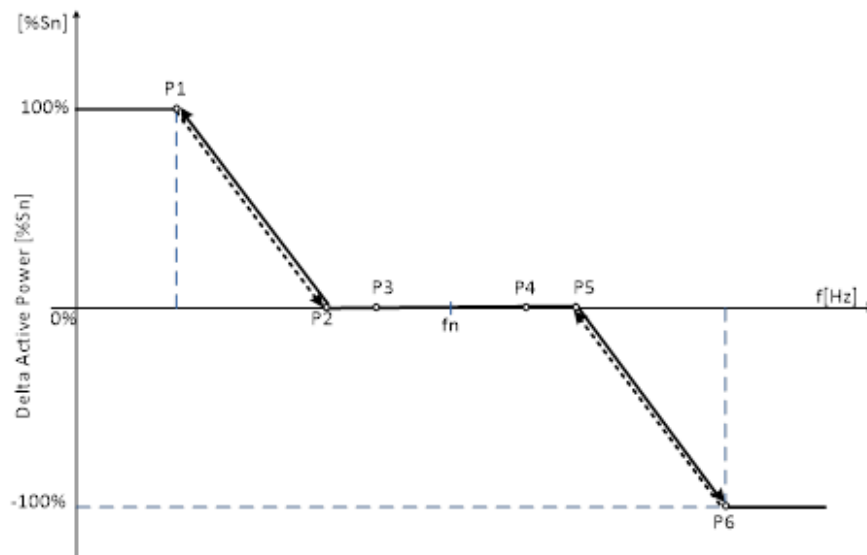

P – The Conext XW Pro output active power in percentage of nominal rated active power S_n [% S_n].

f - Utility grid frequency in Hz

Table 32 Rule 21 P(f) Frequency-Watt function default and adjustability range settings

Parameter	Frequency [Hz]		Active Power [% P_n]	
	Default	Range	Default	Range
Point P1	58	56 to 59	100	0 to 100
Point P2	59.96	59 to 59.96	0	0
Point P3	59.98	59 to 60	0	0

Point P4	60.02	60 to 61	0	0
Point P5	60.04	60.04 to 61	0	0
Point P6	62	61 to 64	-100	-100 to 0

NOTE: If both P(V) and P(f) are active then the lesser of the two power levels shall take precedence (i.e. the curve that is curtailing the active power the most shall set the output power level)

Voltage Ride Through (VRT)

The Conext XW Pro has the capability of remaining connected to the utility grid and operational for defined time intervals (ride-through) while AC voltage deviates from the nominal range, as shown in the figure below. At the end of ride-through time, if the utility grid voltage has not recovered to normal range, the Conext XW Pro will disconnect and transition to Inverter (Grid-Forming) Mode.

Voltage Ride-through is enabled by default.

Figure 37 High/Low Voltage Ride-through (HVRT/LVRT) regions

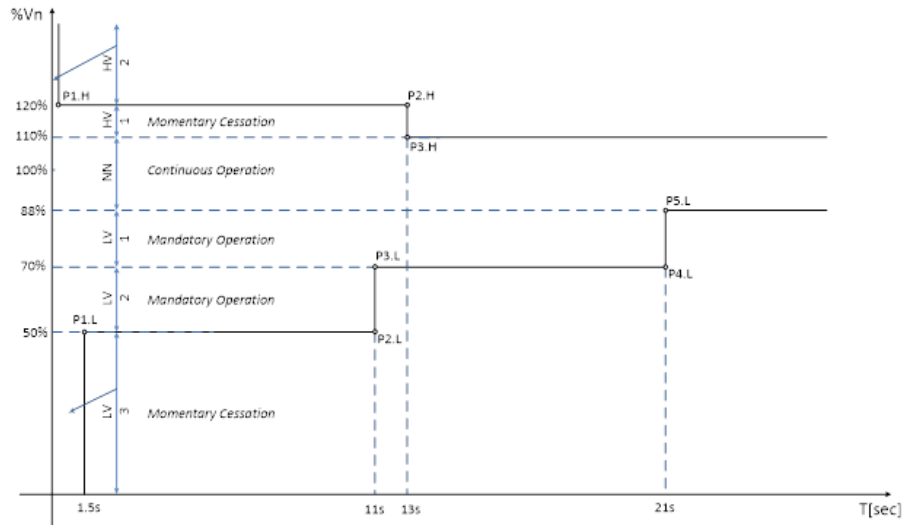

- When in the Continuous Operation region (Near Nominal), the Conext XW Pro operates indefinitely without tripping.
- When in Low-Voltage 1 (LV1) or Low-Voltage (LV2) region, the Conext XW Pro goes into Mandatory Operation (i.e. generates an output current greater than or equal to 80% of pre-disturbance current value).
- When in the Low-Voltage 3 (LV3) or High-Voltage 1 (HV1) region, the Conext XW Pro goes into Momentary Cessation (i.e. decreases the output current to less than 10% of nominal AC output current and remain online for the ride-through specified time, with the capability of immediate restore normal operation when utility grid voltage returns to near-nominal range).
- When in the High-Voltage 2 (HV2) region, the Conext XW Pro goes into Cease to Energise (i.e. stops injecting output current to the utility grid; it does not imply galvanic isolation or disconnection).

Table 33 Rule 21 High Voltage Ride-through (HVRT) default and adjustability range settings

HVRT	Time [s]		Voltage [%Vn]	
	Default	Range	Default	Range
Point P1.H	0.16	N/A	120	115 to 125
Point P2.H	13	1 to 13	120	115 to 125
Point P3.H	13	1 to 13	110	100 to 115

Table 34 Rule 21 Low Voltage Ride-through (LVRT) default and adjustability range settings

LVRT	Time [s]		Voltage [%Vn]	
	Default	Range	Default	Range
Point P1.L	1.5	0.16 to 1.5	50	0 to 50
Point P2.L	11	1 to 11	50	0 to 50
Point P3.L	11	1 to 11	70	50 to 80
Point P4.L	21	2 to 21	70	50 to 80
Point P5.L	21	2 to 21	88	80 to 100

Frequency Ride-Through (FRT)

The Conext XW Pro has the capability of remaining connected to the utility grid and operational for defined time intervals (ride-through) while AC frequency deviates from nominal range, as seen in the figure below.

- At the end of ride-through time, if the utility grid frequency has not recovered to the near nominal (NN) range, the Conext XW Pro will disconnect and transition to Inverter (Grid-Forming) Mode.

Frequency Ride-through is enabled by default.

Figure 38 High/Low Frequency Ride-through (HFRT/LFRT) regions

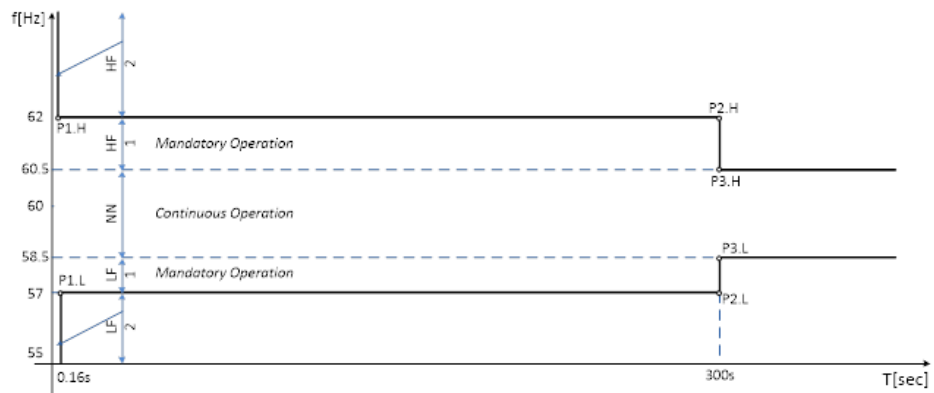

- When in Continuous Operation region (Near Nominal), Conext XW Pro operates indefinitely without tripping.
- When in Low-Frequency 1 (LF2) or High-Frequency 2 (HF2) regions, Conext XW Pro

goes into Momentary Cessation (i.e. stop injecting output current to utility grid; it does not imply galvanic isolation or disconnection).

- When in Low-Frequency 1 (LF1) and High-Frequency 1 (HF1), Conext XW Pro goes into Mandatory Operation (i.e. generates an output current greater than or equal to 80% of pre-disturbance current value).

Table 35 Rule 21 High Frequency Ride-through (HFRT) default and adjustability range settings

HFRT	Time [s]		Frequency [Hz]	
	Default	Range	Default	Range
Point P1.H	0.16	0.16 to 10	62	62 to 64
Point P2.H	300	2 to 300	62	62 to 64
Point P3.H	300	2 to 300	60.5	60.1 to 62

Table 36 Rule 21 Low Frequency Ride-through (LFRT) default and adjustability range settings

LFRT	Time [s]		Frequency [Hz]	
	Default	Range	Default	Range
Point P1.L	0.16	0.16 to 10	57	53 to 57
Point P2.L	300	2 to 300	57	53 to 57
Point P3.L	300	2 to 300	58.5	57 to 59.9

Ramp Rates

Normal Ramp Rate

During normal operation, any transition between power output levels will be executed at a ramp rate no larger than the Normal Ramp Rate setting. Normal Ramp Rate is contingent upon sufficient energy available at the Conext XW Pro DC input port.

Normal Ramp Rate function is enabled by default.

Figure 39 Normal ramp rate

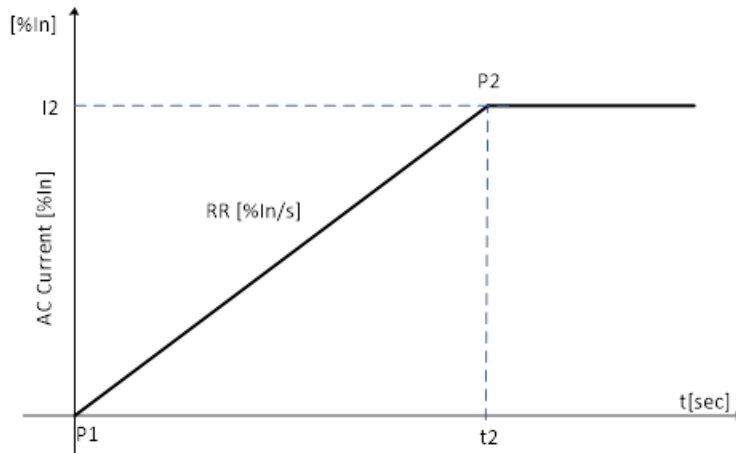

- Normal Ramp rate is defined as a slope measured in percentage of AC nominal current per second [%In/sec].
- Default Normal Ramp Rate value is 100 [%In/sec] with an adjustability range from 1 to 100 [%In/sec].

Parameter	AC Current per second [%In/s]	
	Default	Range
Ramp Rate	100	1 to 100

Parameter	Time [s]		AC Current [%In]	
	Default	Range	Default	Range
Point P1	0	N/A	0	N/A
Point P2	1	N/A	100	N/A

Reconnection (Soft-Start) Ramp Rate

Upon starting up, returning to service, or re-connecting, the Conext XW Pro limits the rate of exported/generated active power to no larger than the Ramp Rate setting.

Normal Ramp Rate function is enabled by default.

Figure 40 Reconnection ramp rate

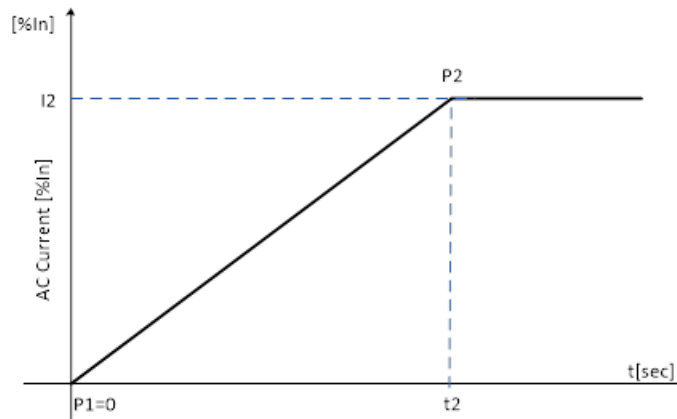

- Normal Ramp rate is defined as a slope measured in percentage of AC nominal current per second [%In/sec].
- The default Normal Ramp Rate value is 2 [%In/sec] with an adjustability range from 1 to 100 [%In/sec].

Parameter	AC Current per second [%In/s]	
	Default	Range
Ramp Rate	2	N/A

Parameter	Time [s]		AC Current [%In]	
	Default	Range	Default	Range
Point P1	0	N/A	0	N/A
Point P2	50	1 to 100	100	N/A

Grid Disconnect Settings

The Conext XW Pro will remain connected to the utility grid as long as voltage and frequency are within the qualified range (i.e. less than the Over Voltage/Frequency limit and higher than the Under Voltage/Frequency limit).

California Rule 21 implements voltage and frequency disconnect limits via High/Low Voltage Ride Through (H/LVRT) and via High/Low Frequency Ride Through (H/LFRT) curves.

Grid voltage and frequency disconnect settings are defined in the table below, and take effect only when the H/LVRT and H/LFRT curves are disabled.

Table 37 Rule 21 Grid Disconnect Settings

Anti-Islanding Disconnect Slow Delay	The disconnection time delay for the grid voltage exceeding an over-voltage level, but lower than the fast disconnection level. The default value for this setting is 0.5 seconds.
Anti-Islanding Disconnect Over Frequency	The frequency above which the Conext XW Pro will stop export of power and record an islanding fault. The default value for this setting is 62Hz. The disconnect will occur if the inverter is over frequency for 0.1 seconds.
Anti-Islanding Disconnect Under Frequency	The frequency below which the Conext XW Pro will stop export of power and record an islanding fault. The default value for this setting is 57 Hz, and the disconnect will occur if the inverter is under frequency for 0.1 seconds.
Anti-Islanding Disconnect Over Voltage L-N Fast	The line-to-neutral voltage above which the Conext XW Pro will stop export of power and record an islanding fault. The default value for this setting is 144 V.
Anti-Islanding Disconnect Over Voltage L-N Slow	The line-to-neutral voltage above which the Conext XW Pro will stop export of power and record an islanding fault. The default value for this setting is 132 V, and the disconnect will occur if the inverter is over frequency for 0.5 seconds.
Anti-Islanding Disconnect Over Voltage L1-L2 Fast	The line-to-line voltage above which the Conext XW Pro will stop export of power and record an islanding fault. The default value for this setting is 288 V.
Anti-Islanding Disconnect Over Voltage L1-L2 Slow	The line-to-line voltage above which the Conext XW Pro will stop export of power and record an islanding fault. The default value for this setting is 264 V, and the disconnect will occur if the inverter is over voltage for 0.5 seconds.
Anti-Islanding Disconnect Under Voltage L-N Fast	The line-to-neutral voltage below which the Conext XW Pro will stop export of power and record an islanding fault. The default value for this setting is 60 V.

Anti-Islanding Disconnect Under Voltage L-N Slow	The line-to-neutral voltage below which the Conext XW Pro will stop export of power and record an islanding fault. The default value for this setting is 84 V, and the disconnect will occur if the inverter is under frequency for 0.5 seconds.
Anti-Islanding Disconnect Under Voltage L1-L2 Fast	The line-to-line voltage below which the Conext XW Pro will stop export of power and record an islanding fault. The default value for this setting is 120 V.
Anti-Islanding Disconnect Under Voltage L1-L2 Slow	The line-to-line voltage below which the Conext XW Pro will stop export of power and record an islanding fault. The default value for this setting is 168 V, and the disconnect will occur if the inverter is under frequency for 0.5 seconds.
Transient Over-Voltage (TrOV) trip time	The disconnection time delay for the grid voltage exceeding the TrOV Trip level. The default value for this setting is 0.016 seconds.
Transient Over-Voltage (TrOV) trip level	When Transient Over-Voltage is enabled, grid voltage in percentage of nominal value [%Vn], above which the Conext XW Pro will stop operating after the TrOV trip time. The default value is 120 [%Vn].

Table 38 Rule 21 Grid Disconnect default and adjustability range settings

Parameter	Default	Range	Unit
Anti-Islanding Disconnect Slow Delay	0.5	0.2 to 10	[s]
Anti-Islanding Disconnect Over Frequency	62	62 to 64	[Hz]
Anti-Islanding Disconnect Under Frequency	57	53 to 57	[Hz]
Anti-Islanding Disconnect Over Voltage LN Fast	144	138 to 150	[V]
Anti-Islanding Disconnect Over Voltage LN Slow	132	120 to 138	[V]
Anti-Islanding Disconnect Over Voltage L1L2 Fast	288	276 to 300	[V]
Anti-Islanding Disconnect Over Voltage L1L2 Slow	264	240 to 276	[V]
Anti-Islanding Disconnect Under Voltage LN Fast	60	0 to 60	[V]
Anti-Islanding Disconnect Under Voltage LN Slow	84	60 to 96	[V]
Anti-Islanding Disconnect Under Voltage L1L2 Fast	120	0 to 120	[V]
Anti-Islanding Disconnect Under Voltage L1L2 Slow	168	120 to 192	[V]
TrOV trip time	16	10 to 200	[ms]
TrOV trip level	120	100 to 150	[%Vn]

Grid Reconnect Settings

At initial start-up or upon disconnection, the Conext XW Pro will remain offline until the voltage and frequency are within the qualified range (i.e. less than Over Voltage/Frequency limit and higher than Under Voltage/Frequency limit).

Table 39 Rule 21 Grid Reconnection default and adjustability range settings

Parameter	Default	Range	Unit
Anti-Islanding Reconnect Time	300	15 to 300	[s]
HF Reconnect Frequency	60.5	60.1 to 61	[Hz]
LF Reconnect Frequency	58.5	58 to 59.9	[Hz]
HV Reconnect Nominal Voltage	105.83	100 to 110	[%Vn]
LV Reconnect Nominal Voltage	88.33	88 to 100	[%Vn]

Anti-Islanding Reconnect Time	Grid reconnection time delay at initial start-up or upon disconnection. The default value for this setting is 300 seconds.
HF Reconnect Frequency	The frequency below which the Conext XW Pro will initialize grid reconnection process. The default value for this setting is 60.5 Hz.
LF Reconnect Frequency	The frequency above which the Conext XW Pro will initialize grid reconnection process. The default value for this setting is 58.5 Hz).
HV Reconnect Voltage	The voltage below which the Conext XW Pro will initialize grid reconnection process. The default value for this setting is 105.83 [%Vn] (percentage of nominal voltage).
LF Reconnect Voltage	The voltage above which the Conext XW Pro will initialize grid reconnection process. The default value for this setting is 88.33 [%Vn] (percentage of nominal voltage).

Hawaiian Electric Company (HECO) Rule No. 14: Smart Inverter Grid-Support Utility Interactive Functions

HECO Rule No. 14 – 2018 Specifications

- Source Requirements Document:
 - Hawaiian Electric Company (HECO) Grid Support Utility-Interactive Standards Source Requirement Document Version 1.1 (SRD-UL-1741-SA-V1.1) effective September 16, 2017
 - HECO RULE NO. 14 – Appendix I – Section 4A – Advanced Inverter Generating Facility Operating Requirements, effective October 22, 2018.
- Programmable Setting Access: Access parameters and/or adjust features using Conext Gateway

Q(V) Volt-VAr Function

Reactive Power capabilities

The reactive power capability of the Conext XW Pro utility-interactive inverter in Grid-Support Mode is shown within the area defined by the blue boundary (S1 to S6) on *Figure 41*.

Reactive power output is prioritized above active power generation; if necessary, the Conext XW Pro will reduce active power output to provide reactive power demanded by either Volt-VAr or Fixed Power Factor functions.

Figure 41 Conext XW Pro Reactive Power capability

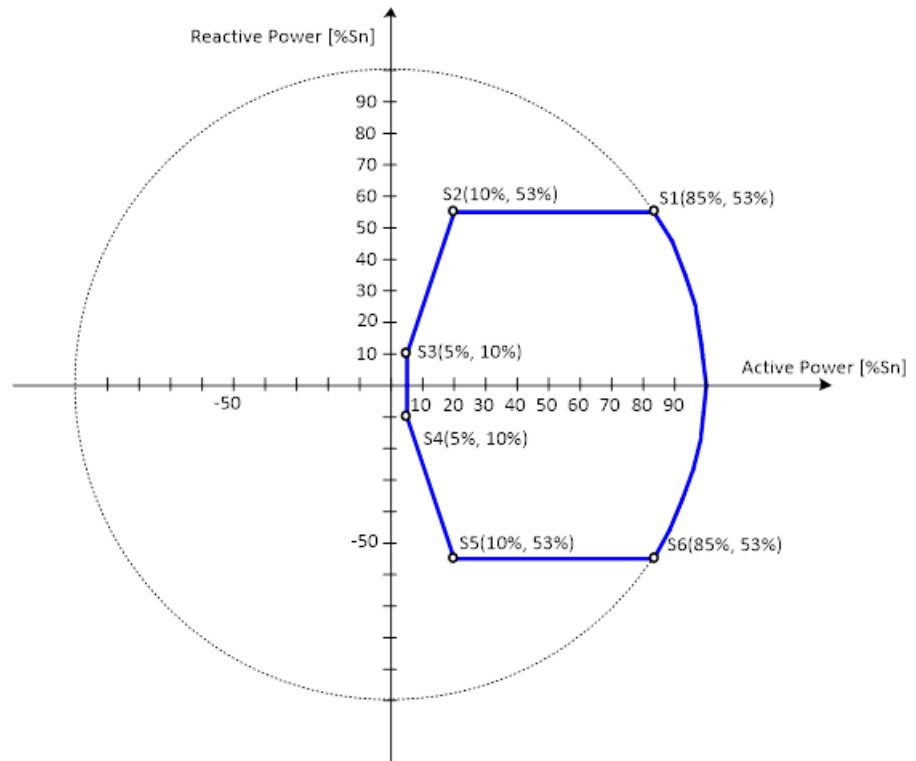

Reactive Power Grid Support

When the Q(V) Volt-VAr function is enabled, the Conext XW Pro is in Grid Support mode. Reactive power output is actively control as a function of the voltage following the Volt-VAr piecewise linear characteristic in the figure below.

- The Conext XW Pro dynamically injects reactive power into the grid following the P1P2 segment when AC voltage trends lower than the nominal value
- The Conext XW Pro dynamically absorbs reactive power from the utility grid following the P5P6 segment when AC voltage trends higher than the nominal value
- By generating or consuming reactive power in response to grid voltage fluctuations, Conext XW Pro contributes to grid stabilization towards the nominal voltage.

The Q(V) function is enabled by default.

Figure 42 Q(V) Volt-Var Function

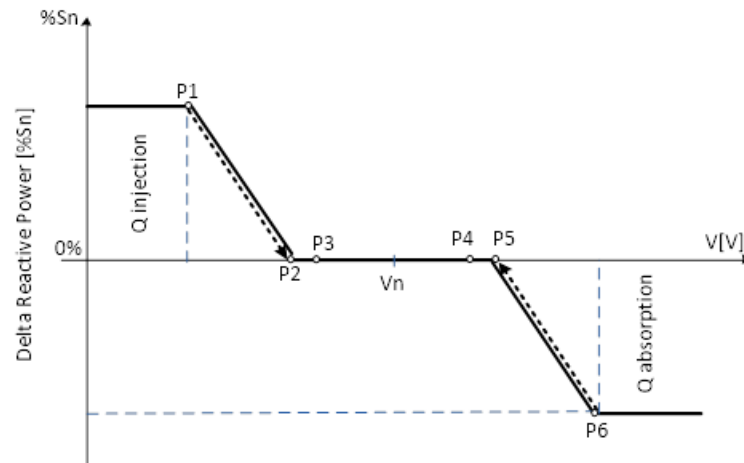

Q – The Conext XW Pro output reactive power in percentage of nominal rated apparent power Sn.

For example, Q1 = 44% means Q1=2640 VAR for Sn=6000 kVA of the Conext XW Pro nominal rated apparent power.

V - Utility grid voltage in percentage) of nominal voltage Vn

For example, V1 = 94% means V1=225.6 V for 240 V nominal grid.

Table 40 HECO Q(V) Volt-Var function default and adjustability range settings

Parameter	Voltage [%Vn]		Reactive Power [%Sn]	
	Default	Range	Default	Range
Vref	100	95 to 105	N/A	N/A
Point P1	Vref - 6	82 to (V2-2)	44	0 to +100
Point P2	Vref - 3	(Vref-3) to Vref	0	0
Point P3	Vref - 2	(Vref-3) to Vref	0	0
Point P4	Vref + 2	100 to (Vref+3)	0	0
Point P5	Vref + 3	100 to (Vref+3)	0	0
Point P6	Vref + 6	(V3+2) to 118	-44	-100 to 0

The Reactive Power Volt-Var function has priority over generated active power. The Conext XW Pro may need to reduce produced active power to meet the reactive power demand.

Fixed Power Factor Function

This function allows the user to set the Conext XW Pro output Power Factor in Grid Support Mode.

- The Power factor (PF) is controllable from 20% to 100% nominal output power and default setting is PF = 0.95 leading.

- Power Factor setting adjustability range from with an adjustability range from - 0.85 lagging to 0.85 leading (EEI³ Power Factor sign convention).
- When enabled, the PF setting has priority over other functions, which means that active power may be reduced to achieve the power factor setpoint.

The Fixed Power Factor function is disabled by default.

Figure 43 Fixed Power Factor function

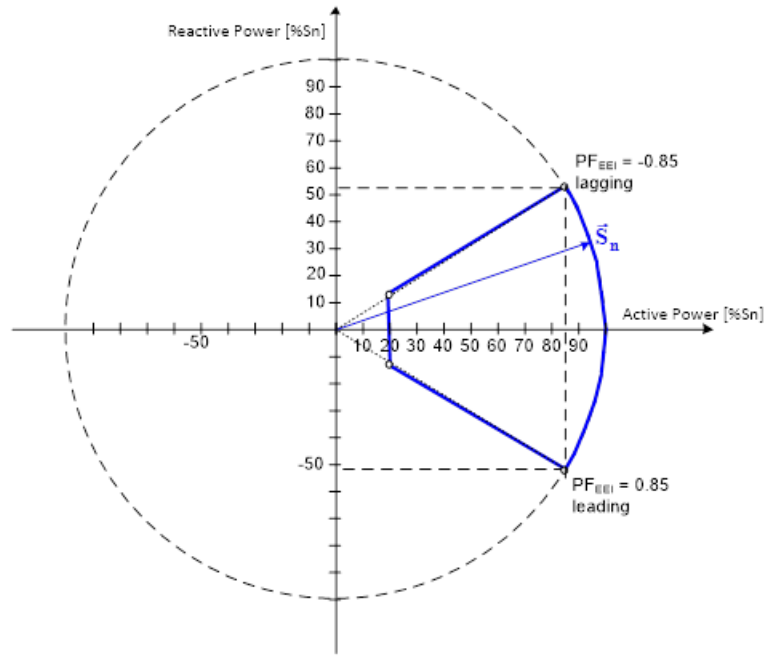

Table 41 HECO Fixed Power Factor Function default and adjustability range settings

Parameter	Default	Range	Observations
Power Factor	0.95 leading	1	EEI Generator reference frame convention ²
		(-0.85 to -0.99) lagging	
		(0.85 to 0.99) leading	

³EEI – Edison Electric Institute

²EEI - Edison Electric Institute

P(V) Volt-Watt Function

When the Conext XW Pro is in Grid Support mode and P(V) function is enabled:

- The Conext XW Pro dynamically increases the active power injected into the utility grid from the pre-disturbance level when AC voltage trends lower than V2, following the P1P2 segment in the figure below.
- The Conext XW Pro dynamically curtails active power injected into the utility grid from the pre-disturbance level when AC voltage trends higher than V5, following P5P6 segment in the figure below.
- By adjusting the active power in response to grid voltage fluctuations, Conext XW Pro contributes to grid stabilization towards the nominal value.

The P(V) function is disabled by default.

Figure 44 P(V) Volt-Watt Function

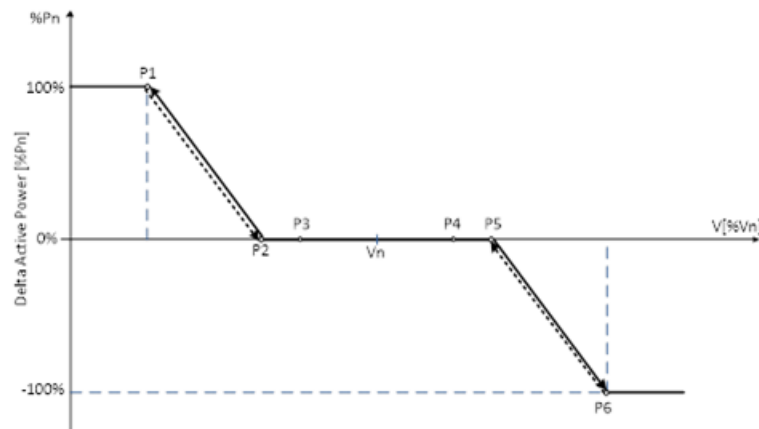

P – The Conext XW Pro output active power in percentage of nominal rated active power Pn.

V - Utility grid voltage in percentage) of nominal voltage Vn

For example, V1 = 90% means V1=216 V for Vn = 240 V nominal grid.

Table 42 HECO P(V) Volt-Watt function default and adjustability range settings

Parameter	Voltage [% Vn]		Active Power [%Pn]	
	Default	Range	Default	Range
Point P1	90	90 to 94	100	0 to 100
Point P2	94	91 to 95	0	0
Point P3	95	91 to 96	0	0
Point P4	105	104 to 109	0	0
Point P5	106	105 to 109	0	0
Point P6	110	106 to 110	-100	-100 to 0

NOTE: If both P(V) and P(f) are active, the lesser of the two power levels will take precedence (i.e. the curve that is curtailing the active power the most will set the output power level).

P(f) Frequency-Watt Function

When the Conext XW Pro is in Grid Support mode and P(f) function is enabled:

- The Conext XW Pro dynamically increases the active power injected into the grid from the pre-disturbance level when AC frequency trends lower than f_2 , following the P1P2 segment in the figure below.
- The Conext XW Pro dynamically curtails active power injected into utility grid from the pre-disturbance level when AC frequency trends higher than f_5 in the figure below.
- By adjusting the active power in response to grid frequency fluctuations, Conext XW Pro contributes to grid stabilization towards the nominal value.

The P(f) function is enabled by default.

Figure 45 P(f) Frequency-Watt Function

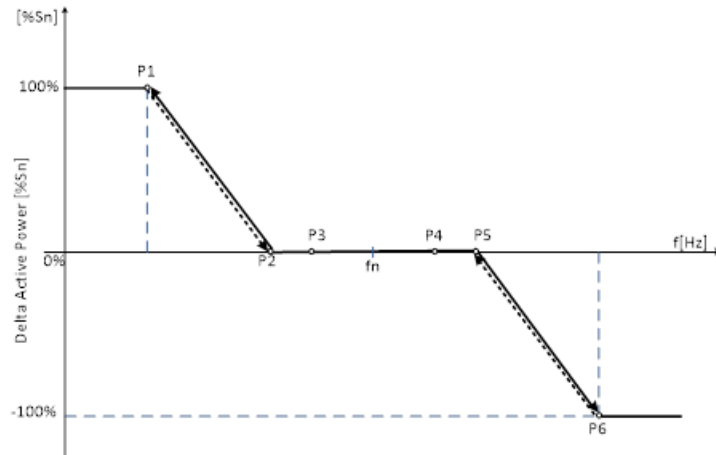

P – The Conext XW Pro output active power in percentage of nominal rated active power S_n [% S_n].

f - Utility grid frequency in Hz

Table 43 HECO P(f) Frequency-Watt function default and adjustability range settings

Parameter	Frequency [Hz]		Active Power [%Pn]	
	Default	Range	Default	Range
Point P1	57.76	58.78 to 59	100	0 to 100
Point P2	59.96	59 to 59.96	0	0
Point P3	59.98	59 to 60	0	0
Point P4	60.02	60 to 61	0	0
Point P5	60.04	60.01 to 61	0	0
Point P6	62.44	61 to 64.22	-100	-100 to 0

NOTE: If both P(V) and P(f) are active then the lesser of the two power levels shall take precedence (i.e. the curve that is curtailing the active power the most shall set the output power level)

Voltage Ride Through (VRT)

The Conext XW Pro has the capability of remaining connected to the utility grid and operational for defined time intervals (ride-through) while AC voltage deviates from the nominal range, as shown in the figure below. At the end of ride-through time, if the utility grid voltage has not recovered to normal range, the Conext XW Pro will disconnect and transition to Inverter (Grid-Forming) Mode.

Voltage Ride-through is enabled by default.

Figure 46 High/Low Voltage Ride-through (HVRT/LVRT) regions

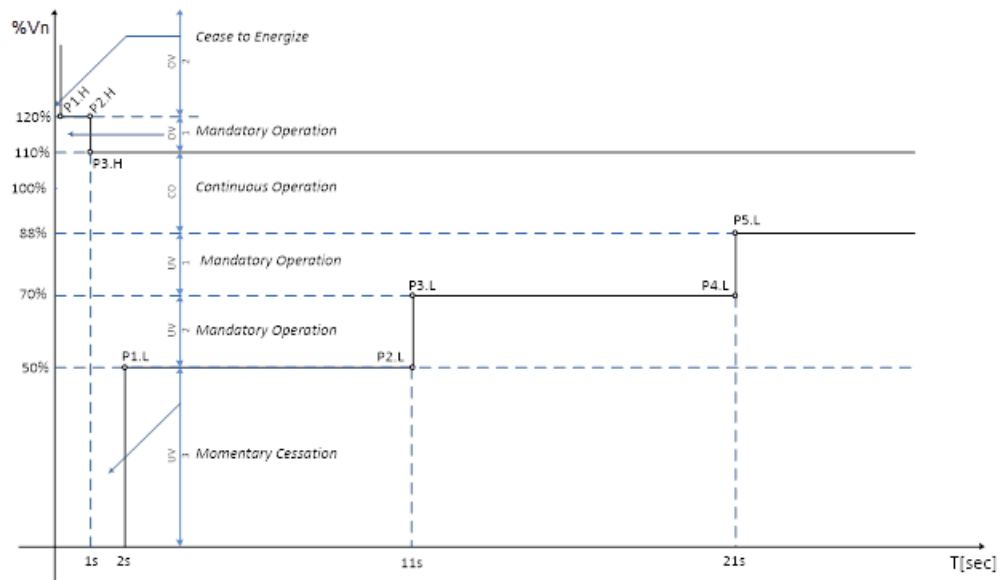

- When in the Continuous Operation region (Near Nominal), the Conext XW Pro operates indefinitely without tripping.
- While in Under Voltage 1 (UV1), 2 (UV2) or Over Voltage 1 (OV1), the Conext XW Pro goes into Mandatory Operation (i.e. generates an output current greater than or equal to 80% of pre-disturbance current value).
- When in the Under Voltage 3 (UV3) region, the Conext XW Pro goes into Momentary Cessation (i.e. decreases the output current to less than 10% of nominal AC output current).
- While in the Over Voltage 2 (OV2) region, the Conext XW Pro goes into Cease to Energise (i.e. stops injecting output current to the utility grid; it does not imply galvanic isolation or disconnection).

Table 44 HECO High Voltage Ride-through (HVRT) default and adjustability range settings

HVRT	Time [s]		Voltage [%Vn]	
	Default	Range	Default	Range
Point P1.H	0.16	N/A	120	N/A
Point P2.H	1	1 to 13	120	N/A
Point P3.H	1	1 to 13	110	110 to 120

Table 45 HECO Low Voltage Ride-through (LVRT) default and adjustability range settings

LVRT	Time [s]		Voltage [%Vn]	
	Default	Range	Default	Range
Point P1.L	2	0.5 to 21	50	N/A
Point P2.L	11	11 to 50	50	N/A
Point P3.L	11	11 to 50	70	50 to 88
Point P4.L	21	21 to 50	70	50 to 88
Point P5.L	21	21 to 50	88	50 to 88

Frequency Ride-Through (FRT)

The Conext XW Pro has the capability of remaining connected to the utility grid and operational for defined time intervals (ride-through) while AC frequency deviates from nominal range, as seen in the figure below.

- At the end of ride-through time, if the utility grid frequency has not recovered to the normal range, the Conext XW Pro will disconnect and transition to Inverter (Grid-Forming) Mode.

Frequency Ride-through is enabled by default.

Figure 47 High/Low Frequency Ride-through (HFRT/LFRT) regions

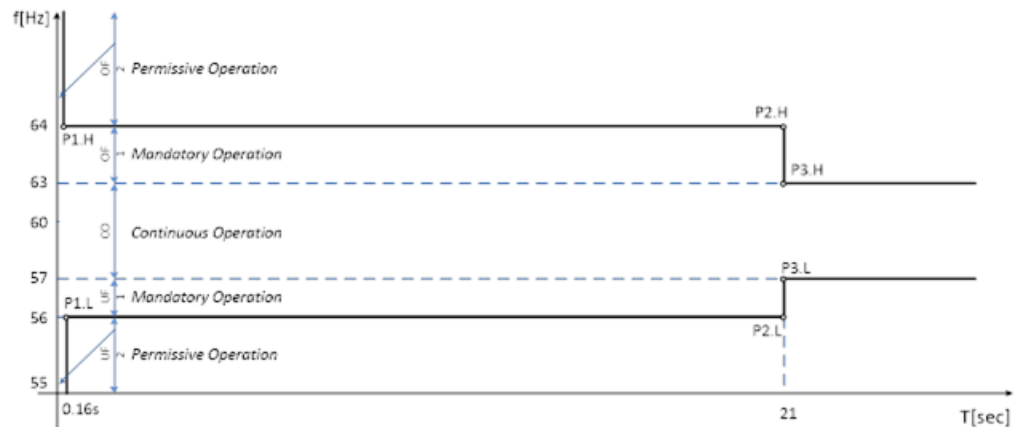

- When in the Under Frequency 1 (UF2) or Over Frequency 2 (OV2) regions, the Conext XW Pro goes into Permissive Operation (i.e. it may operate at any current level during ride-through time).
- While in the Under Frequency 1 (UF1) or Over Frequency 1 (OF1), the Conext XW Pro goes into Mandatory Operation (i.e. generates an output current greater than or equal to 80% of pre-disturbance current value).
- When in the Continuous Operation region (CO), the Conext XW Pro operates indefinitely without tripping.

Table 46 HECO (Oahu, Maui, Hawaii Island) High Frequency Ride-through (HFRT) default and adjustability range settings

HVRT	Time [s]		Frequency [Hz]	
	Default	Range	Default	Range
Point P1.H	0.16	0.16 to 1000	64	62 to 66
Point P2.H	21	21 to 1000	64	62 to 66
Point P3.H	21	21 to 1000	63	61 to 66

Table 47 HECO (Oahu, Maui, Hawaii Island) Low Frequency Ride-through (LFRT) default and adjustability range settings

LVRT	Time [s]		Frequency [Hz]	
	Default	Range	Default	Range
Point P1.L	0.16	0.16 to 1000	56	50 to 57
Point P2.L	21	21 to 1000	56	50 to 57
Point P3.L	21	21 to 1000	57	50 to 59

Table 48 HECO (Molokai and Lanai) High Frequency Ride-through (HFRT) default and adjustability range settings

HVRT	Time [s]		Voltage [%Vn]	
	Default	Range	Default	Range
Point P1.H	0.16	0.16 to 1000	65	62 to 66
Point P2.H	21	21 to 1000	65	62 to 66
Point P3.H	21	21 to 1000	63	61 to 66

Table 49 HECO (Molokai and Lanai) Low Frequency Ride-through (LFRT) default and adjustability range settings

LVRT	Time [s]		Voltage [%Vn]	
	Default	Range	Default	Range
Point P1.L	0.16	0.16 to 1000	50	50 to 57
Point P2.L	21	21 to 1000	50	50 to 57
Point P3.L	21	21 to 1000	57	50 to 59

Ramp Rates

Normal Ramp Rate

During normal operation, any transition between power output levels will be executed at a ramp rate no larger than the Normal Ramp Rate setting. Normal Ramp Rate is contingent upon sufficient energy available at the Conext XW Pro DC input port.

Normal Ramp Rate function is enabled by default.

Figure 48 Normal ramp rate

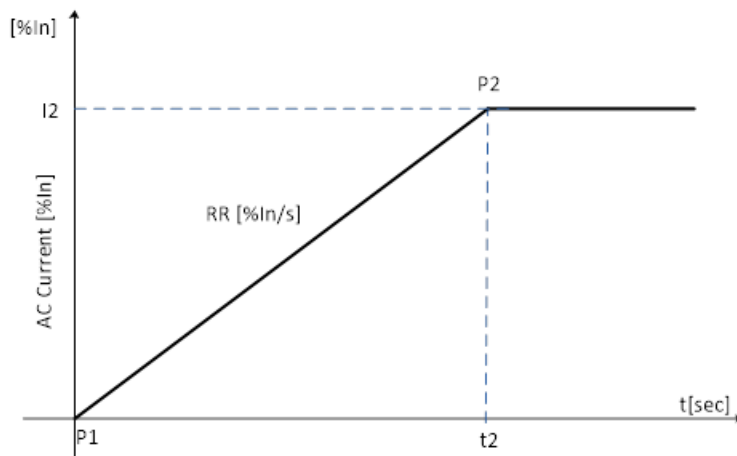

- Normal Ramp rate is defined as a slope measured in percentage of AC nominal current per second [%In/sec].
- Default Normal Ramp Rate value is 100 [%In/sec] with an adjustability range from 1 to 100 [%In/sec].

Parameter	AC Current per second [%In/s]	
	Default	Range
Ramp Rate	100	1 to 100

Parameter	Time [s]		AC Current [%In]	
	Default	Range	Default	Range
Point P1	0	N/A	0	N/A
Point P2	1	N/A	100	N/A

Reconnection (Soft-Start) Ramp Rate

Upon starting up, returning to service, or re-connecting, the Conext XW Pro limits the rate of exported/generated active power to no larger that the Ramp Rate setting.

Normal Ramp Rate function is enabled by default.

Figure 49 Reconnection ramp rate

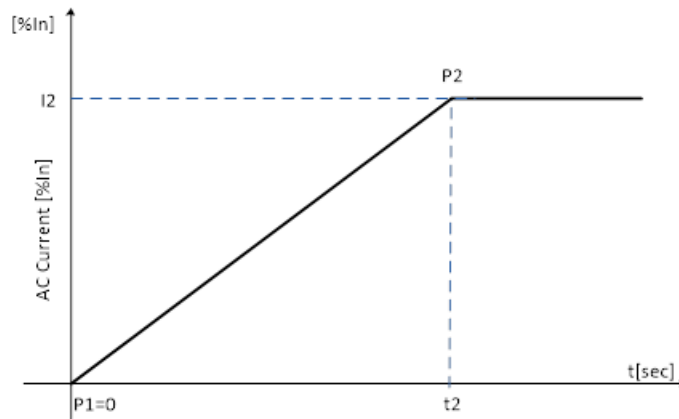

- Normal Ramp rate is defined as a slope measured in percentage of AC nominal current per second [%In/sec].
- The default Normal Ramp Rate value is 0.33 [%In/sec] with an adjustability range from 0.1 to 100 [%In/sec].

Parameter	AC Current per second [%In/s]	
	Default	Range
Ramp Rate	0.33	N/A

Parameter	Time [s]		AC Current [%In]	
	Default	Range	Default	Range
Point P1	0	N/A	0	N/A
Point P2	303	1 to 1000	100	N/A

Grid Disconnect Settings

The Conext XW Pro will remain connected to the utility grid as long as voltage and frequency are within the qualified range (i.e. less than the Over Voltage/Frequency limit and higher than the Under Voltage/Frequency limit).

HECO implements voltage and frequency disconnect limits via High/Low Voltage Ride Through (H/LVRT) and via High/Low Frequency Ride Through (H/LFRT) curves.

Grid voltage and frequency disconnect settings are defined in the table below, and take effect only when the H/LVRT and H/LFRT curves are disabled.

Table 50 HECO Grid Disconnect Settings

Anti-Islanding Disconnect Slow Delay	The disconnection time delay for the grid voltage exceeding an over-voltage voltage level, but lower than the fast disconnection level. The default value for this setting is 0.5 seconds.
Anti-Islanding Disconnect Over Frequency	The frequency above which the Conext XW Pro will stop export of power and record an islanding fault. The default value for this setting is 64Hz (Oahu, Maui, Hawaii Island) and 65Hz (Molokai and Lanai). The disconnect will occur if the inverter is over frequency for 0.1 seconds.
Anti-Islanding Disconnect Under Frequency	The frequency below which the Conext XW Pro will stop export of power and record an islanding fault. The default value for this setting is 56Hz (Oahu, Maui, Hawaii Island), 50Hz (Molokai and Lanai). The disconnect will occur if the inverter is under frequency for 0.1 seconds.
Anti-Islanding Disconnect Over Voltage L-N Fast	The line-to-neutral voltage above which the Conext XW Pro will stop export of power and record an islanding fault. The default value for this setting is 144 V.
Anti-Islanding Disconnect Over Voltage L-N Slow	The line-to-neutral voltage above which the Conext XW Pro will stop export of power and record an islanding fault. The default value for this setting is 132 V, and the disconnect will occur if the inverter is over frequency for 0.5 seconds.
Anti-Islanding Disconnect Over Voltage L1-L2 Fast	The line-to-line voltage above which the Conext XW Pro will stop export of power and record an islanding fault. The default value for this setting is 288 V.
Anti-Islanding Disconnect Over Voltage L1-L2 Slow	The line-to-line voltage above which the Conext XW Pro will stop export of power and record an islanding fault. The default value for this setting is 264 V, and the disconnect will occur if the inverter is over frequency for 0.5 seconds.
Anti-Islanding Disconnect Under Voltage L-N Fast	The line-to-neutral voltage below which the Conext XW Pro will stop export of power and record an islanding fault. The default value for this setting is 60 V.
Anti-Islanding Disconnect Under Voltage L-N Slow	The line-to-neutral voltage below which the Conext XW Pro will stop export of power and record an islanding fault. The default value for this setting is 84 V, and the disconnect will occur if the inverter is under frequency for 0.5 seconds.
Anti-Islanding Disconnect Under Voltage L1-L2 Fast	The line-to-line voltage below which the Conext XW Pro will stop export of power and record an islanding fault. The default value for this setting is 168 V.

Anti-Islanding Disconnect Under Voltage L1-L2 Slow	The line-to-line voltage below which the Conext XW Pro will stop export of power and record an islanding fault. The default value for this setting is 120 V, and the disconnect will occur if the inverter is under frequency for 0.5 seconds.
Transient Over-Voltage (TrOV) trip time	The disconnection time delay for the grid voltage exceeding the TrOV Trip level. The default value for this setting is 0.016 seconds.
Transient Over-Voltage (TrOV) trip level	When Transient Over-Voltage is enabled, grid voltage in percentage of nominal value [%Vn], above which the Conext XW Pro will stop operating after the TrOV trip time. The default value is 120 [%Vn].

Table 51 HECO (Oahu, Maui, Hawaii Island) Grid Disconnect default and adjustability range settings

Parameter	Default	Range	Unit
Anti-Islanding Disconnect Slow Delay	0.5	0.2 to 10	[s]
Anti-Islanding Disconnect Over Frequency	64	62 to 66	[Hz]
Anti-Islanding Disconnect Under Frequency	56	50 to 57	[Hz]
Anti-Islanding Disconnect Over Voltage LN Fast	144	138 to 150	[V]
Anti-Islanding Disconnect Over Voltage LN Slow	132	120 to 138	[V]
Anti-Islanding Disconnect Over Voltage L1L2 Fast	288	276 to 300	[V]
Anti-Islanding Disconnect Over Voltage L1L2 Slow	264	240 to 276	[V]
Anti-Islanding Disconnect Under Voltage LN Fast	60	0 to 60	[V]
Anti-Islanding Disconnect Under Voltage LN Slow	84	60 to 96	[V]
Anti-Islanding Disconnect Under Voltage L1L2 Fast	120	0 to 120	[V]
Anti-Islanding Disconnect Under Voltage L1L2 Slow	168	120 to 192	[V]
TrOV trip time	16	10 to 200	[ms]
TrOV trip level	120	100 to 150	[%Vn]

Table 52 HECO (Molokai, Lanai) Grid Disconnect default and adjustability range settings

Parameter	Default	Range	Unit
Anti-Islanding Disconnect Slow Delay	0.5	0.2 to 10	[s]
Anti-Islanding Disconnect Over Frequency	65	62 to 66	[Hz]
Anti-Islanding Disconnect Under Frequency	50	50 to 57	[Hz]
Anti-Islanding Disconnect Over Voltage LN Fast	144	138 to 150	[V]
Anti-Islanding Disconnect Over Voltage LN Slow	132	120 to 138	[V]
Anti-Islanding Disconnect Over Voltage L1L2 Fast	288	276 to 300	[V]
Anti-Islanding Disconnect Over Voltage L1L2 Slow	264	240 to 276	[V]
Anti-Islanding Disconnect Under Voltage LN Fast	60	0 to 60	[V]

Anti-Islanding Disconnect Under Voltage LN Slow	84	60 to 96	[V]
Anti-Islanding Disconnect Under Voltage L1L2 Fast	120	0 to 120	[V]
Anti-Islanding Disconnect Under Voltage L1L2 Slow	168	120 to 192	[V]
TrOV trip time	16	10 to 200	[ms]
TrOV trip level	120	100 to 150	[%Vn]

Grid Reconnect Settings

At initial start-up or upon disconnection, the Conext XW Pro will remain offline until the voltage and frequency are within the qualified range (i.e. less than Over Voltage/Frequency limit and higher than Under Voltage/Frequency limit).

Table 53 HECO Grid Reconnection default and adjustability range settings

Parameter	Default	Range	Unit
Anti-Islanding Reconnect Time	300	0 to 600	[s]
HF Reconnect Frequency	60.10	60.1 to 61	[Hz]
LF Reconnect Frequency	59.90	58 to 59.9	[Hz]
HV Reconnect Nominal Voltage	110	100 to 110	[%Vn]
LV Reconnect Nominal Voltage	88	88 to 100	[%Vn]

Anti-Islanding Reconnect Time	Grid reconnection time delay at initial start-up or upon disconnection. The default value for this setting is 300 seconds.
HF Reconnect Frequency	The frequency below which the Conext XW Pro will initialize grid reconnection process. The default value for this setting is 60.1 Hz.
LF Reconnect Frequency	The frequency above which the Conext XW Pro will initialize grid reconnection process. The default value for this setting is 59.9 Hz.
HV Reconnect Voltage	The voltage below which the Conext XW Pro will initialize grid reconnection process. The default value for this setting is 110 [%Vn] (percentage of nominal voltage).
LV Reconnect Voltage	The voltage above which the Conext XW Pro will initialize grid reconnection process. The default value for this setting is 88 [%Vn] (percentage of nominal voltage).

Transient Overvoltage (TrOV)

Transient over-voltage (TrOV) is a short duration, rapid rise in voltage along electric lines that can damage utility or consumer equipment. Under certain circumstances, Distributed Energy Resources (DER) have the potential to generate transient over-voltages. To address these concerns, Hawaiian Electric Company (HECO) developed stringent requirements and tests procedures (TrOV-2) that smart grid-interactive inverters

must comply with. Advanced construction and controls allow the Conext XW Pro to meet and pass the rigorous HECO TrOV-2 requirements.

The TrOV function is enabled by default and the corresponding parameters are shown in *Grid Disconnect Settings on page 153, see Table 50 to Table 52.*

IEEE 1547-2003 Standard for Interconnecting Distributed Resources with Electric Power System (60Hz and 50Hz)

Q(V) Volt-VAr Function

When the Q(V) Volt-VAr function is enabled, the Conext XW Pro is in Grid Support mode and AC voltage deviates from nominal range:

- The Conext XW Pro dynamically injects reactive power into the grid following the P1P2 segment when AC voltage trends lower than the nominal value.
- The Conext XW Pro dynamically absorbs reactive power from the utility grid following the P5P6 segment when AC voltage trends higher than the nominal value.

The Q(V) function is disabled by default.

Figure 50 Q(V) Volt-Var Function

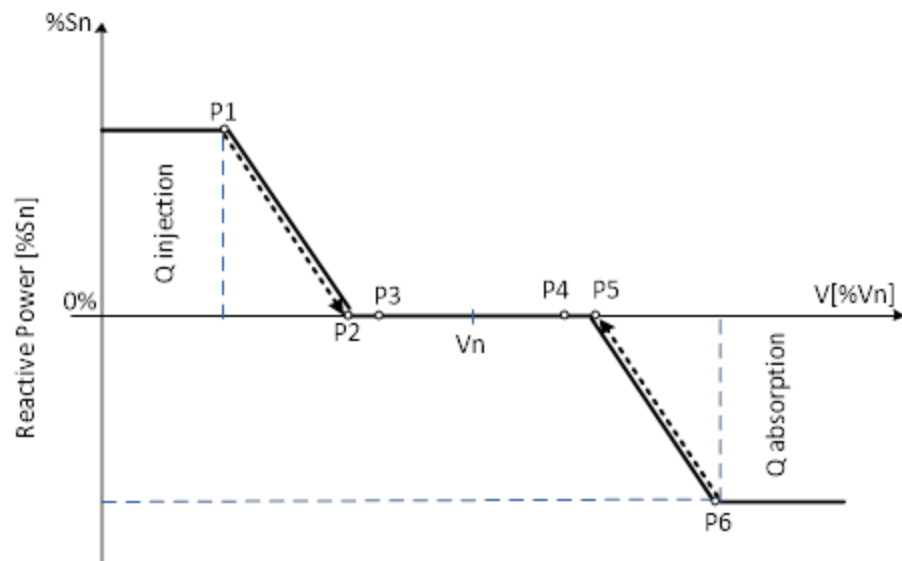

Q – The Conext XW Pro output reactive power in percentage of nominal rated apparent power S_n .

For example, $Q_1 = 30\%$ means $Q_1 = 1800 \text{ VAr}$ for $S_n = 6000 \text{ kVA}$ of the Conext XW Pro nominal rated apparent power.

V - Utility grid voltage in percentage) of nominal voltage V_n

For example, $V_1 = 92\%$ means $V_1 = 221 \text{ V}$ for 240 V nominal grid.

Table 54 IEEE1547-2003 Q(V) Volt-Var function default and adjustability range settings

Parameter	Voltage [%Vn]		Reactive Power [%Sn]	
	Default	Range	Default	Range

Point P1	92	85 to 98.75	30	+15 to +60
Point P2	96.7	90 to 100	0	0
Point P3	97	90 to 100	0	0
Point P4	103	100 to 110	0	0
Point P5	103.3	100 to 110	0	0
Point P6	107	101.25 to 112.5	-30	-60 to -15

Fixed Power Factor Function

This function allows the user to set the Conext XW Pro output Power Factor in Grid Support Mode.

- The Power factor (PF) is controllable from 20% to 100% nominal output power.
- Default setting is PF = 0.95 leading.
- Power Factor setting adjustability range from - 0.85 lagging to 0.85 leading (EEI⁴ Power Factor sign convention).
- When enabled, the PF setting has priority over other functions, which means that active power may be reduced to achieve the power factor setpoint.

The Fixed Power Factor function is disabled by default.

Figure 51 Fixed Power Factor function

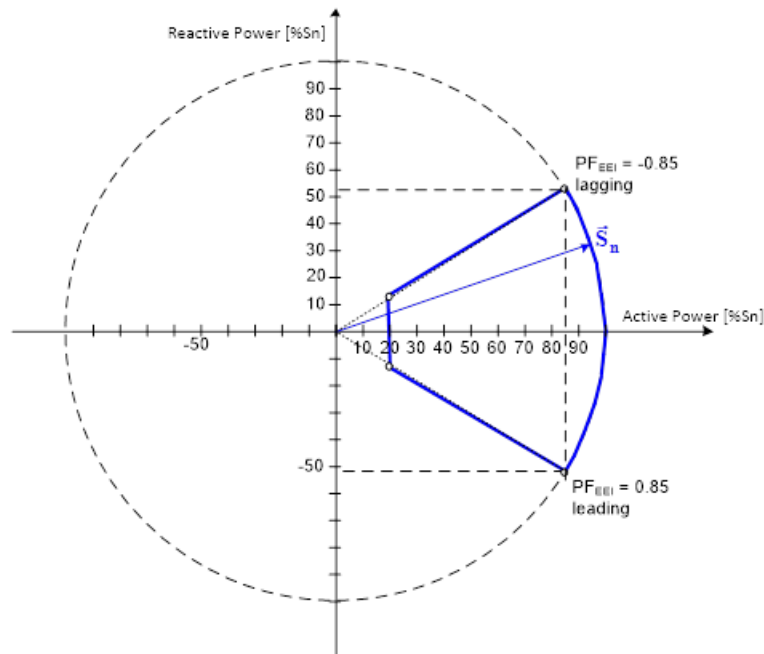

Table 55 IEEE1547-2003 Fixed Power Factor Function default and adjustability range settings

Parameter	Default	Range	Observations
-----------	---------	-------	--------------

⁴EEI – Edison Electric Institute

Power Factor	0.95 leading	1	EEI Generator reference frame convention ¹
		(-0.85 to -0.99) lagging	
		(0.85 to 0.99) leading	

¹EEI - Edison Electric Institute

P(V) Volt-Watt Function

When the Conext XW Pro is in Grid Support mode and P(V) function is enabled:

- The Conext XW Pro dynamically increases the active power injected into the utility grid when AC voltage trends lower than V2 following P1P2 segment in the figure below.
- The Conext XW Pro dynamically curtails active power injected into the utility grid when AC voltage trends higher than V5, following P5P6 segment in the figure below.

The P(V) function is disabled by default.

Figure 52 P(V) Volt-Watt Function

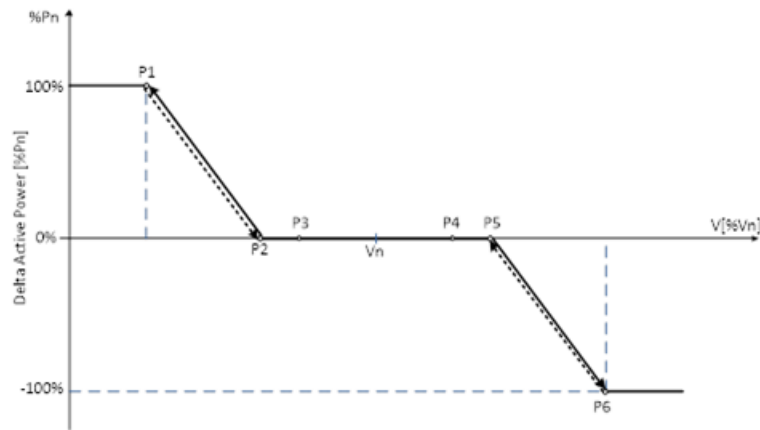

P – The Conext XW Pro output active power in percentage of nominal rated active power Pn.

V - Utility grid voltage in percentage) of nominal voltage Vn

For example, V1 = 90% means V1=216 V for Vn = 240 V nominal grid.

Table 56 IEEE1547-2003 P(V) Volt-Watt function default and adjustability range settings

Parameter	Voltage [% Vn]		Active Power [%Pn]	
	Default	Range	Default	Range
Point P1	90	85 to 99	100	0 to 100
Point P2	94	90 to 99	0	0
Point P3	95	90 to 100	0	0
Point P4	105	100 to 110	0	0
Point P5	106	101 to 110	0	0
Point P6	110	101 to 115	-100	-100 to 0

NOTE: If both P(V) and P(f) are active, the lesser of the two power levels will take precedence (i.e. the curve that is curtailing the active power the most will set the output power level).

P(f) Frequency-Watt Function

When the Conext XW Pro is in Grid Support mode and P(f) function is enabled:

- The Conext XW Pro dynamically increases the active power injected into the grid from the pre-disturbance level when AC frequency trends lower than f_2 , following the P1P2 segment in the figure below.
- The Conext XW Pro dynamically curtails active power injected into utility grid from the pre-disturbance level when AC frequency trends higher than f_{52} , following the P5P6 segment in the figure below.

The P(f) function is disabled by default.

Figure 53 P(f) Frequency-Watt Function

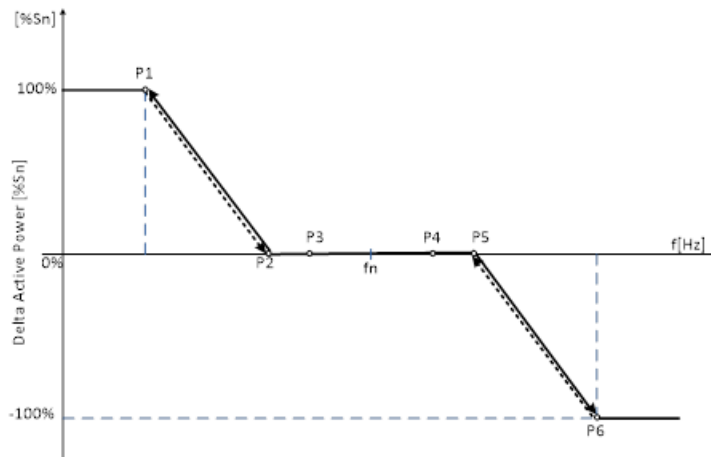

P – The Conext XW Pro output active power in percentage of nominal rated active power S_n [% S_n].

f - Utility grid frequency in Hz

Table 57 IEEE1547-2003 P(f) Frequency-Watt function default and adjustability range settings – 60 Hz

Parameter	Frequency [Hz]		Active Power [% P_n]	
	Default	Range	Default	Range
Point P1	58	56 to 59	100	0 to 100
Point P2	59.96	59 to 59.96	0	0
Point P3	59.98	59 to 60	0	0
Point P4	60.02	60 to 61	0	0
Point P5	60.04	60.04 to 61	0	0
Point P6	62	61 to 64	-100	-100 to 0

Table 58 IEEE1547-2003 P(f) Frequency-Watt function default and adjustability range settings – 50 Hz

Parameter	Frequency [Hz]		Active Power [%Pn]	
	Default	Range	Default	Range
Point P1	48	46 to 49	100	0 to 100
Point P2	49.96	49 to 49.96	0	0
Point P3	49.98	49 to 50	0	0
Point P4	50.02	50 to 51	0	0
Point P5	50.04	50.04 to 51	0	0
Point P6	52	51 to 54	-100	-100 to 0

NOTE: If both P(V) and P(f) are active then the lesser of the two power levels shall take precedence (i.e. the curve that is curtailing the active power the most shall set the output power level)

Voltage Ride Through (VRT)

The Conext XW Pro has the capability of remaining connected to the utility grid and operational for defined time intervals (ride-through) while AC voltage deviates from the nominal range, as shown in the figure below. At the end of ride-through time, if the utility grid voltage has not recovered to normal range, the Conext XW Pro will disconnect and transition to Inverter (Grid-Forming) Mode.

Voltage Ride-through is disabled by default.

Figure 54 High/Low Voltage Ride-through (HVRT/LVRT) regions

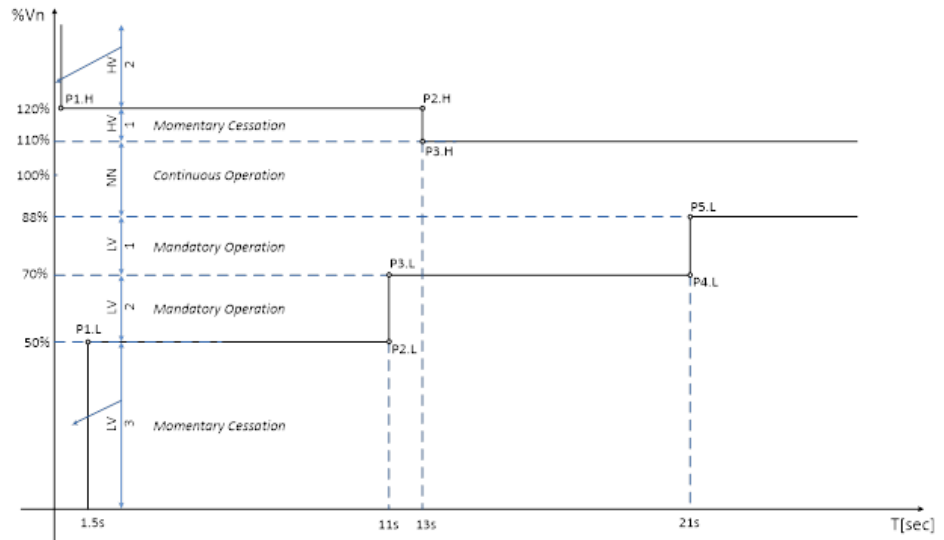

- When in the Continuous Operation region (Near Nominal), the Conext XW Pro operates indefinitely without tripping.
- When in Low-Voltage 1 (LV1) or Low-Voltage 2 (LV2), the Conext XW Pro goes into Mandatory Operation (i.e. generates an output current greater than or equal to 80% of pre-disturbance current value).

- When in the Low-Voltage 3 (LV3) region or High-Voltage 1 (HV1) region, the Conext XW Pro goes into Momentary Cessation (i.e. decreases the output current to less than 10% of nominal AC output current).
- When in the High-Voltage 2 (HV2) region, the Conext XW Pro goes into Momentary Cessation (i.e. stops injecting output current to the utility grid; it does not imply galvanic isolation or disconnection).

Table 59 IEEE1547-2003 High Voltage Ride-through (HVRT) default and adjustability range settings

HVRT	Time [s]		Voltage [%Vn]	
	Default	Range	Default	Range
Point P1.H	0.16	N/A	120	115 to 125
Point P2.H	13	1 to 13	120	115 to 125
Point P3.H	13	1 to 13	110	100 to 115

Table 60 IEEE1547-2003 Low Voltage Ride-through (LVRT) default and adjustability range settings

LVRT	Time [s]		Voltage [%Vn]	
	Default	Range	Default	Range
Point P1.L	1.5	0.16 to 1.5	50	0 to 50
Point P2.L	11	1 to 11	50	0 to 50
Point P3.L	11	1 to 11	70	50 to 80
Point P4.L	21	2 to 21	70	50 to 80
Point P5.L	21	2 to 21	88	80 to 100

Frequency Ride-Through (FRT)

The Conext XW Pro has the capability of remaining connected to the utility grid and operational for defined time intervals (ride-through) while AC frequency deviates from nominal range, as seen in the figure below.

- At the end of ride-through time, if the utility grid frequency has not recovered to the near nominal or normal range, the Conext XW Pro will disconnect and transition to Inverter (Grid-Forming) Mode.

Frequency Ride-through is disabled by default.

Figure 55 High/Low Frequency Ride-through (HFRT/LFRT) regions

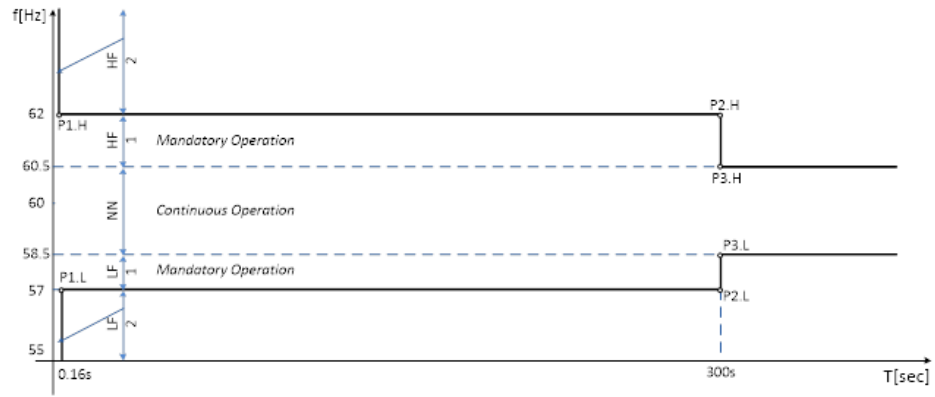

- When in the Low-Frequency 2 (LF2) or High-Frequency 2 (HF22) regions, the Conext XW Pro goes into Momentary Cessation (i.e. stop injecting output current to utility grid; it does not imply galvanic isolation or disconnection).
- When in the Low-Frequency 1 (ULF1) or High-Frequency 1 (HF1), the Conext XW Pro goes into Mandatory Operation (i.e. generates an output current greater than or equal to 80% of pre-disturbance current value).
- When in the Continuous Operation region (Near Nominal), the Conext XW Pro operates indefinitely without tripping.

Table 61 IEEE1547-2003 High Frequency Ride-through (HFRT) default and adjustability range settings – 60 Hz

HFRT	Time [s]		Frequency [Hz]	
	Default	Range	Default	Range
Point P1.H	0.16	0.16 to 10	62	62 to 64
Point P2.H	300	2 to 300	62	62 to 64
Point P3.H	300	2 to 300	60.5	60.1 to 62

Table 62 IEEE1547-2003 Low Frequency Ride-through (LFRT) default and adjustability range settings – 60 Hz

LFRT	Time [s]		Frequency [Hz]	
	Default	Range	Default	Range
Point P1.L	0.16	0.16 to 10	57	53 to 57
Point P2.L	300	2 to 300	57	53 to 57
Point P3.L	300	2 to 300	58.5	57 to 59.9

Table 63 IEEE1547-2003 High Frequency Ride-through (HFRT) – 50 Hz

HFRT	Time [s]		Voltage [%Vn]	
	Default	Range	Default	Range
Point P1.H	0.16	0.16 to 10	52	52 to 54
Point P2.H	300	2 to 300	52	52 to 54
Point P3.H	300	2 to 300	50.5	50.1 to 52

Table 64 IEEE1547-2003 Low Frequency Ride-through (LFRT) default and adjustability range settings – 50 Hz

LFRT	Time [s]		Voltage [%Vn]	
	Default	Range	Default	Range
Point P1.L	0.16	0.16 to 10	47	50 to 57
Point P2.L	300	2 to 300	47	50 to 57
Point P3.L	300	2 to 300	48.5	47 to 49.9

Ramp Rates

Normal Ramp Rate

During normal operation, any transition between power output levels will be executed at a ramp rate no larger than the Normal Ramp Rate setting. Normal Ramp Rate is contingent upon sufficient energy available at the Conext XW Pro DC input port.

Normal Ramp Rate function is enabled by default.

Figure 56 Normal ramp rate

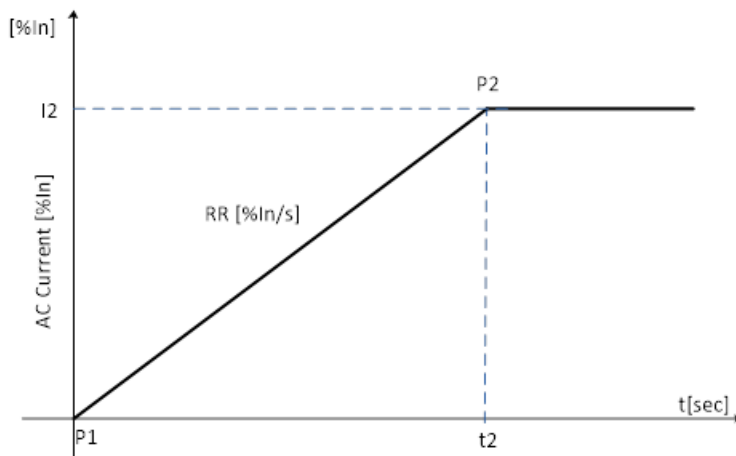

- Normal Ramp rate is defined as a slope measured in percentage of AC nominal current per second [%In/sec].
- Default Normal Ramp Rate value is 50 [%In/sec] with an adjustability range from 1 to 100 [%In/sec].

Parameter	AC Current per second [%In/s]	
	Default	Range
Ramp Rate	50	1 to 100

Parameter	Time [s]		AC Current [%In]	
	Default	Range	Default	Range
Point P1	0	N/A	0	N/A
Point P2	2	N/A	100	N/A

Reconnection (Soft-Start) Ramp Rate

Upon starting up, returning to service, or re-connecting, the Conext XW Pro limits the rate of exported/generated active power to no larger than the Ramp Rate setting.

Normal Ramp Rate function is enabled by default.

Figure 57 Reconnection ramp rate

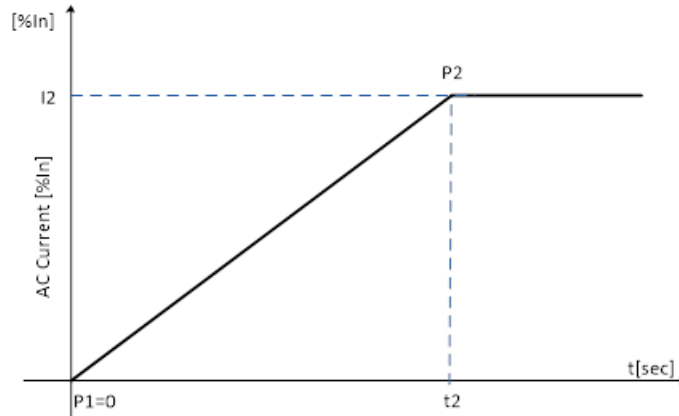

- Normal Ramp rate is defined as a slope measured in percentage of AC nominal current per second [%In/sec].
- The default Normal Ramp Rate value is 2 [%In/sec] with an adjustability range from 1 to 100 [%In/sec].

Parameter	AC Current per second [%In/s]	
	Default	Range
Ramp Rate	2	N/A

Parameter	Time [s]		AC Current [%In]	
	Default	Range	Default	Range
Point P1	0	N/A	0	N/A
Point P2	50	1 to 100	100	N/A

Grid Disconnect Settings

The Conext XW Pro will remain connected to the utility grid as long as voltage and frequency are within the qualified range (i.e. less than the Over Voltage/Frequency limit and higher than the Under Voltage/Frequency limit).

Grid voltage and frequency disconnect settings are defined in the table below, and take effect only when the H/LVRT and H/LFRT curves are disabled.

Table 65 IEEE1547-2003 Grid Disconnect Settings

Anti-Islanding Disconnect Slow Delay	The disconnection time delay for the grid voltage exceeding an over-voltage voltage level, but lower than the fast disconnection level. The default value for this setting is 0.5 seconds.
Anti-Islanding Disconnect Over Frequency	The frequency above which the Conext XW Pro will stop export of power and record an islanding fault. The default value for this setting is 60.5 Hz (for 60Hz grid) and 50.5Hz (for 50Hz grid). The disconnect will occur if the inverter is over frequency for 0.1 seconds.
Anti-Islanding Disconnect Under Frequency	The frequency below which the Conext XW Pro will stop export of power and record an islanding fault. The default value for this setting is 59.3 Hz (for 60Hz grid) and 49.3Hz (for 50Hz grid). The disconnect will occur if the inverter is under frequency for 0.1 seconds.
Anti-Islanding Disconnect Over Voltage L-N Fast	The line-to-neutral voltage above which the Conext XW Pro will stop export of power and record an islanding fault. The default value for this setting is 135 V.
Anti-Islanding Disconnect Over Voltage L-N Slow	The line-to-neutral voltage above which the Conext XW Pro will stop export of power and record an islanding fault. The default value for this setting is 132 V, and the disconnect will occur if the inverter is over frequency for 0.5 seconds.
Anti-Islanding Disconnect Over Voltage L1-L2 Fast	The line-to-line voltage above which the Conext XW Pro will stop export of power and record an islanding fault. The default value for this setting is 270 V.
Anti-Islanding Disconnect Over Voltage L1-L2 Slow	The line-to-line voltage above which the Conext XW Pro will stop export of power and record an islanding fault. The default value for this setting is 264 V, and the disconnect will occur if the inverter is over frequency for 0.5 seconds.
Anti-Islanding Disconnect Under Voltage L-N Fast	The line-to-neutral voltage below which the Conext XW Pro will stop export of power and record an islanding fault. The default value for this setting is 65 V.

Anti-Islanding Disconnect Under Voltage L-N Slow	The line-to-neutral voltage below which the Conext XW Pro will stop export of power and record an islanding fault. The default value for this setting is 105.6 V, and the disconnect will occur if the inverter is under frequency for 0.5 second.
Anti-Islanding Disconnect Under Voltage L1-L2 Fast	The line-to-line voltage below which the Conext XW Pro will stop export of power and record an islanding fault. The default value for this setting is 132 V.
Anti-Islanding Disconnect Under Voltage L1-L2 Slow	The line-to-line voltage below which the Conext XW Pro will stop export of power and record an islanding fault. The default value for this setting is 211.2 V, and the disconnect will occur if the inverter is under frequency for 0.5 second.
Transient Over-Voltage (TrOV) trip time	The disconnection time delay for the grid voltage exceeding the TrOV Trip level. The default value for this setting is 0.016 seconds.
Transient Over-Voltage (TrOV) trip level	When Transient Over-Voltage is enabled, grid voltage in percentage of nominal value [%Vn], above which the Conext XW Pro will stop operating after the TrOV trip time. The default value is 120 [%Vn].

Table 66 IEEE1547-2003 Grid Disconnect default and adjustability range settings – 60 Hz

Parameter	Default	Range	Unit
Anti-Islanding Disconnect Slow Delay	0.5	0.2 to 10	[s]
Anti-Islanding Disconnect Over Frequency	60.5	60.1 to 67	[Hz]
Anti-Islanding Disconnect Under Frequency	59.3	53 to 59.9	[Hz]
Anti-Islanding Disconnect Over Voltage LN Fast	135	132 to 150	[V]
Anti-Islanding Disconnect Over Voltage LN Slow	132	120 to 138	[V]
Anti-Islanding Disconnect Over Voltage L1L2 Fast	270	234 to 300	[V]
Anti-Islanding Disconnect Over Voltage L1L2 Slow	264	240 to 276	[V]
Anti-Islanding Disconnect Under Voltage LN Fast	66	0 to 96	[V]
Anti-Islanding Disconnect Under Voltage LN Slow	105.6	60 to 108	[V]
Anti-Islanding Disconnect Under Voltage L1L2 Fast	132	0 to 192	[V]
Anti-Islanding Disconnect Under Voltage L1L2 Slow	211.2	120 to 216	[V]
TrOV trip time	16	10 to 200	[ms]
TrOV trip level	120	100 to 150	[%Vn]

Table 67 IEEE1547-2003 Grid Disconnect default and adjustability range settings – 50 Hz

Parameter	Default	Range	Unit
Anti-Islanding Disconnect Slow Delay	0.5	0.2 to 10	[s]
Anti-Islanding Disconnect Over Frequency	50.5	50.1 to 57	[Hz]
Anti-Islanding Disconnect Under Frequency	49.3	43 to 49.9	[Hz]
Anti-Islanding Disconnect Over Voltage LN Fast	135	132 to 150	[Vrms]
Anti-Islanding Disconnect Over Voltage LN Slow	132	120 to 138	[Vrms]
Anti-Islanding Disconnect Over Voltage L1L2 Fast	270	234 to 300	[Vrms]
Anti-Islanding Disconnect Over Voltage L1L2 Slow	264	240 to 276	[Vrms]
Anti-Islanding Disconnect Under Voltage LN Fast	66	0 to 96	[Vrms]
Anti-Islanding Disconnect Under Voltage LN Slow	105.6	60 to 108	[Vrms]
Anti-Islanding Disconnect Under Voltage L1L2 Fast	132	0 to 192	[Vrms]
Anti-Islanding Disconnect Under Voltage L1L2 Slow	211.2	120 to 216	[Vrms]
TrOV trip time	16	10 to 200	[ms]
TrOV trip level	120	100 to 150	[%Vn]

Grid Reconnect Settings

At initial start-up or upon disconnection, the Conext XW Pro will remain offline until the voltage and frequency are within the qualified range (i.e. less than Over Voltage/Frequency limit and higher than Under Voltage/Frequency limit).

Table 68 IEEE1547-2003 Grid Reconnection default and adjustability range settings – 60 Hz

Parameter	Default	Range	Unit
Anti-Islanding Reconnect Time	300	0 to 300	[s]
HF Reconnect Frequency	60.5	60.1 to 61	[Hz]
LF Reconnect Frequency	59.3	58 to 59.9	[Hz]
HV Reconnect Nominal Voltage	105.83	100 to 110	[%Vn]
LV Reconnect Nominal Voltage	88.33	88 to 100	[%Vn]

Table 69 IEEE1547-2003 Grid Reconnection default and adjustability range settings – 50 Hz

Parameter	Default	Range	Unit
Anti-Islanding Reconnect Time	300	0 to 300	[s]
HF Reconnect Frequency	50.5	50.1 to 51	[Hz]
LF Reconnect Frequency	49.3	48 to 49.9	[Hz]
HV Reconnect Nominal Voltage	105.83	100 to 110	[%Vn]
LV Reconnect Nominal Voltage	88.33	88 to 100	[%Vn]

Anti-Islanding Reconnect Time	Grid reconnection time delay at initial start-up or upon disconnection. The default value for this setting is 300 seconds.
HF Reconnect Frequency	The frequency below which the Conext XW Pro will initialize grid reconnection process. The default value for this setting is 60.5 Hz (for 60 Hz grid) and 50.5 (for 50 Hz grid).
LF Reconnect Frequency	The frequency above which the Conext XW Pro will initialize grid reconnection process. The default value for this setting is 59.3 Hz (for 60 Hz grid) and 49.3 (for 50Hz grid).
HV Reconnect Voltage	The voltage below which the Conext XW Pro will initialize grid reconnection process. The default value for this setting is 105.83 [%Vn] (percentage of nominal voltage).
LF Reconnect Voltage	The voltage above which the Conext XW Pro will initialize grid reconnection process. The default value for this setting is 88.33 [%Vn] (percentage of nominal voltage).

Puerto Rico Energy Power Authority (PREPA) Technical Requirements for Interconnecting Wind and Solar Generation

Q(V) Volt-VAr Function

When the Q(V) Volt-VAr function is enabled, the Conext XW Pro is in Grid Support mode. Reactive power output is actively control as a function of the voltage following the Volt-VAr piecewise linear characteristic in the figure below.

- The Conext XW Pro dynamically injects reactive power into the grid following the P1P2 segment when AC voltage trends lower than the nominal value.
- The Conext XW Pro dynamically absorbs reactive power from the utility grid following the P5P6 segment when AC voltage trends higher than the nominal value.
- By generating or consuming reactive power in response to grid voltage fluctuations, Conext XW Pro contributes to grid stabilization towards the nominal voltage.

The Q(V) function is disabled by default.

Figure 58 Q(V) Volt-Var Function

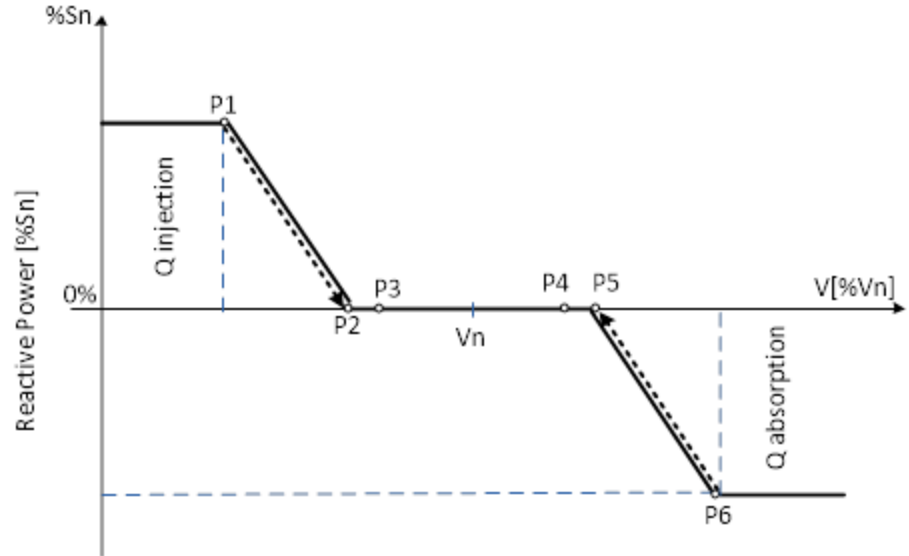

Q – The Conext XW Pro output reactive power in percentage of nominal rated apparent power Sn.

For example, Q1 = 30% means Q1=1800 VAR for Sn=6000 kVA of the Conext XW Pro nominal rated apparent power.

V - Utility grid voltage in percentage) of nominal voltage Vn

For example, V1 = 92% means V1=221 V for 240 V nominal grid.

Table 70 PREPA Q(V) Volt-Var function default and adjustability range settings

Parameter	Voltage [%Vn]		Reactive Power [%Sn]	
	Default	Range	Default	Range
Point P1	92	85 to 98.75	30	+15 to +60
Point P2	96.7	90 to 100	0	0
Point P3	97	90 to 100	0	0
Point P4	103	100 to 110	0	0
Point P5	103.3	100 to 110	0	0
Point P6	107	101.25 to 112.5	-30	-60 to -15

The Reactive Power Volt-Var function has priority over generated active power. The Conext XW Pro may need to reduce produced active power to meet the reactive power demand.

Fixed Power Factor Function

This function allows the user to set the Conext XW Pro output Power Factor in Grid Support Mode.

- The Power Factor (PF) is controllable from 20% to 100% nominal output power and default setting is PF = 0.95 leading.

- Power Factor setting adjustability range from - 0.85 lagging to 0.85 leading (EEI⁵ Power Factor sign convention).
- When enabled, the PF setting has priority over other functions, which means that active power may be reduced to achieve the power factor setpoint.

The Fixed Power Factor function is disabled by default.

Figure 59 Fixed Power Factor function

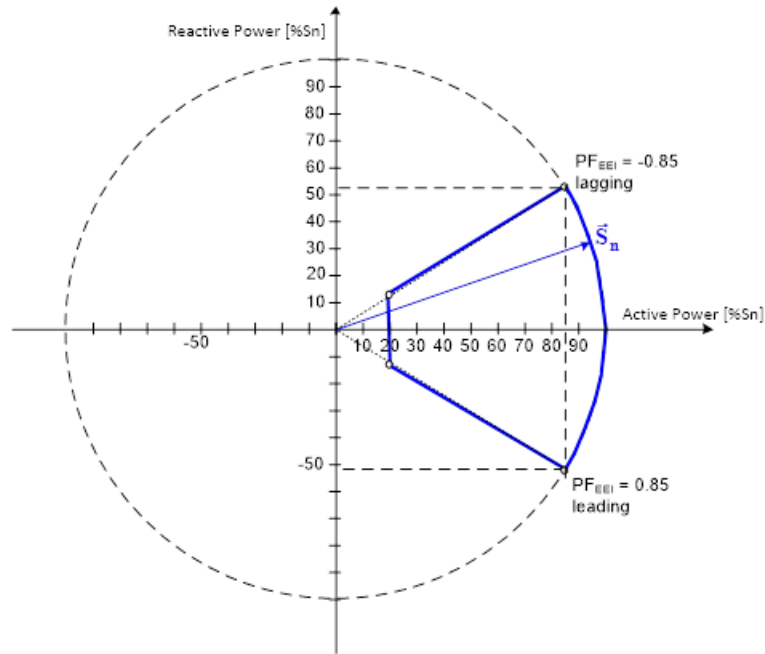

Table 71 PREPA Fixed Power Factor Function default and adjustability range settings

Parameter	Default	Range	Observations
Power Factor	0.95 leading	1	EEI Generator reference frame convention ²
		(-0.85 to -0.99) lagging	
		(0.85 to 0.99) leading	

⁵EEI – Edison Electric Institute

²EEI - Edison Electric Institute

P(V) Volt-Watt Function

When the Conext XW Pro is in Grid Support mode and P(V) function is enabled:

- The Conext XW Pro dynamically increases the active power injected into the utility grid from the pre-disturbance level when AC voltage trends lower than V2, following the P1P2 segment in the figure below.
- The Conext XW Pro dynamically curtails active power injected into the utility grid from the pre-disturbance level when AC voltage trends higher than V5, following P5P6 segment in the figure below.

The P(V) function is disabled by default.

Figure 60 P(V) Volt-Watt Function

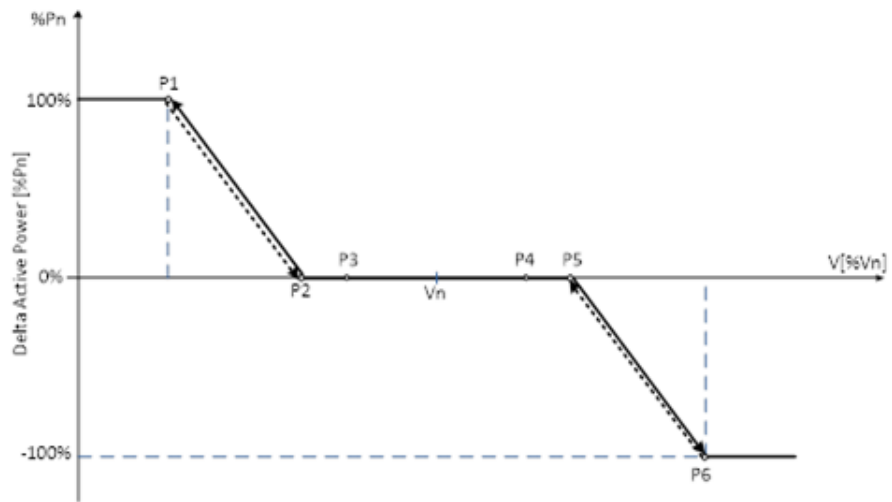

P – The Conext XW Pro output active power in percentage of nominal rated active power Pn.

V - Utility grid voltage in percentage) of nominal voltage Vn [%Vn]

For example, V1 = 90% means V1=216 V for Vn = 240 V nominal grid.

Table 72 PREPA P(V) Volt-Watt function default and adjustability range settings

Parameter	Voltage [% Vn]		Active Power [%Pn]	
	Default	Range	Default	Range
Point P1	90	85 to 98	100	0 to 100
Point P2	94	90 to 98	0	0
Point P3	95	90 to 100	0	0
Point P4	105	100 to 110	0	0
Point P5	106	102 to 110	0	0
Point P6	110	102 to 115	-100	-100 to 0

NOTE: If both P(V) and P(f) are active, the lesser of the two power levels will take precedence (i.e. the curve that is curtailing the active power the most will set the output power level).

P(f) Frequency-Watt Function

When the Conext XW Pro is in Grid Support mode and P(f) function is enabled:

- The Conext XW Pro dynamically increases the active power injected into the grid from the pre-disturbance level when AC frequency trends lower than f_2 , following the P1P2 segment in the figure below.
- The Conext XW Pro dynamically curtails active power injected into utility grid from the pre-disturbance level when AC frequency trends higher than f_5 following the P5P6 segment in the figure below.

The P(f) function is disabled by default.

Figure 61 P(f) Frequency-Watt Function

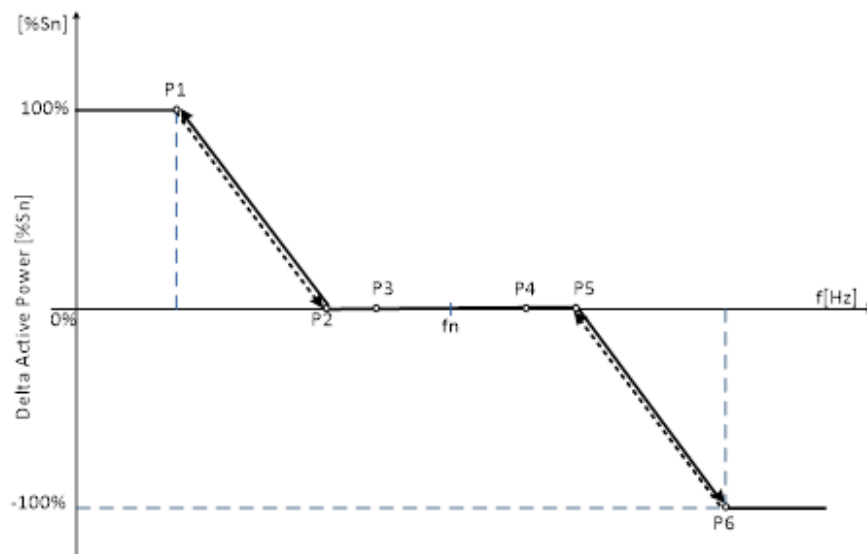

P – The Conext XW Pro output active power in percentage of nominal rated active power S_n [% S_n].

f - Utility grid frequency in Hz

Table 73 PREPA P(f) Frequency-Watt function default and adjustability range settings

Parameter	Frequency [Hz]		Active Power [% P_n]	
	Default	Range	Default	Range
Point P1	58	56 to 59	100	0 to 100
Point P2	59.96	59 to 59.96	0	0
Point P3	59.98	59 to 60	0	0
Point P4	60.02	60 to 61	0	0

Point P5	60.04	60.01 to 61	0	0
Point P6	62	61 to 64.22	-100	-100 to 0

NOTE: If both P(V) and P(f) are active then the lesser of the two power levels shall take precedence (i.e. the curve that is curtailing the active power the most shall set the output power level)

Voltage Ride Through (VRT)

The Conext XW Pro has the capability of remaining connected to the utility grid and operational for defined time intervals (ride-through) while AC voltage deviates from the nominal range, as shown in the figure below. At the end of ride-through time, if the utility grid voltage has not recovered to normal range, the Conext XW Pro will disconnect and transition to Inverter (Grid-Forming) Mode.

Voltage Ride-through is enabled by default.

Figure 62 High/Low Voltage Ride-through (HVRT/LVRT) regions

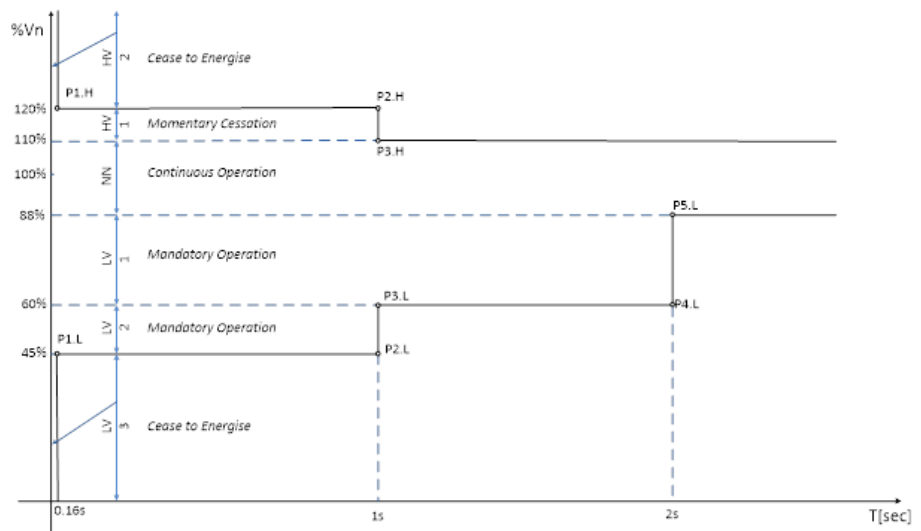

- When in the Continuous Operation region (Near Nominal), the Conext XW Pro operates indefinitely without tripping.
- When in Low-Voltage 1 (LV1) or Low-Voltage (LV2) region, the Conext XW Pro goes into Mandatory Operation (i.e. generates an output current greater than or equal to 80% of pre-disturbance current value).
- When in the High-Voltage 1 (HV1) region, the Conext XW Pro goes into Momentary Cessation (i.e. decreases the output current to less than 10% of nominal AC output current and remain online for the ride-through specified time, with the capability of immediate restore normal operation when utility grid voltage returns to near-nominal range).
- When in the Low-Voltage 3 (LV3) or High-Voltage 2 (HV2) region, the Conext XW Pro goes into Cease to Energise (i.e. stops injecting output current to the utility grid; it does not imply galvanic isolation or disconnection).

Table 74 PREPA High Voltage Ride-through (HVRT) default and adjustability range settings

HVRT	Time [s]		Voltage [%Vn]	
	Default	Range	Default	Range
Point P1.H	0.16	N/A	120	N/A
Point P2.H	1	1 to 13	120	N/A
Point P3.H	1	1 to 13	110	110 to 115

Table 75 PREPA Low Voltage Ride-through (LVRT) default and adjustability range settings

LVRT	Time [s]		Voltage [%Vn]	
	Default	Range	Default	Range
Point P1.L	0.16	N/A	45	0 to 50
Point P2.L	1	1 to 11	45	0 to 50
Point P3.L	1	1 to 11	60	50 to 80
Point P4.L	2	2 to 21	60	50 to 80
Point P5.L	2	2 to 21	88	80 to 100

Frequency Ride-Through (FRT)

The Conext XW Pro has the capability of remaining connected to the utility grid and operational for defined time intervals (ride-through) while AC frequency deviates from nominal range, as seen in the figure below.

- At the end of ride-through time, if the utility grid frequency has not recovered to the near nominal (NN) range, the Conext XW Pro will disconnect and transition to Inverter (Grid-Forming) Mode.

Frequency Ride-through is enabled by default.

Figure 63 High/Low Frequency Ride-through (HFRT/LFRT) regions

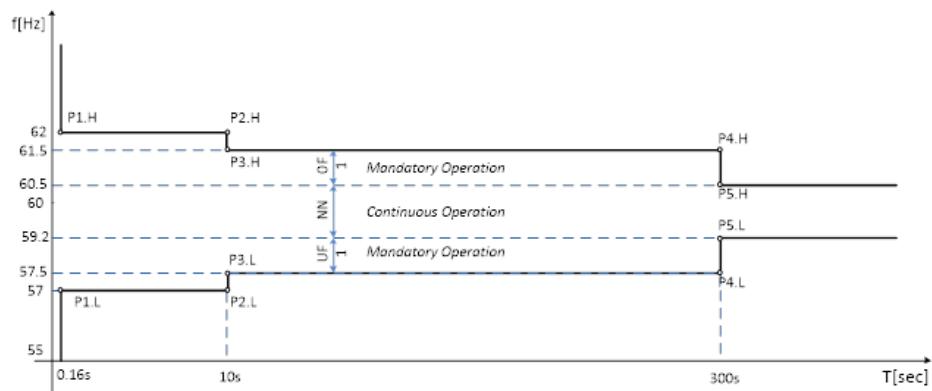

- When in Continuous Operation region (Near Nominal), Conext XW Pro operates indefinitely without tripping.
- When in Under-Frequency 1 (UF1) or Over-Frequency 1 (OF1), Conext XW Pro goes

into Mandatory Operation (i.e. generates an output current greater than or equal to 80% of pre-disturbance current value).

Table 76 PREPA High Frequency Ride-through (HFRT) default and adjustability range settings

HFRT	Time [s]		Frequency [Hz]	
	Default	Range	Default	Range
Point P1.H	0.16	N/A	62	60 to 64
Point P2.H	10	0.16 to 10	62	60 to 64
Point P3.H	10	0.16 to 10	61.5	60 to 64
Point P4.H	300	2 to 300	61.5	60 to 64
Point P5.H	300	2 to 300	60.5	60 to 64

Table 77 PREPA Low Frequency Ride-through (LFRT) default and adjustability range settings

LFRT	Time [s]		Frequency [Hz]	
	Default	Range	Default	Range
Point P1.L	0.16	N/A	57	56 to 60
Point P2.L	10	0.16 to 10	57	56 to 60
Point P3.L	10	0.16 to 10	57.5	56 to 60
Point P4.L	300	2 to 300	57.5	56 to 60
Point P5.L	300	2 to 300	59.2	56 to 60

Ramp Rates

Normal Ramp Rate

During normal operation, any transition between power output levels will be executed at a ramp rate no larger than the Normal Ramp Rate setting. Normal Ramp Rate is contingent upon sufficient energy available at the Conext XW Pro DC input port.

Normal Ramp Rate function is enabled by default.

Figure 64 Normal ramp rate

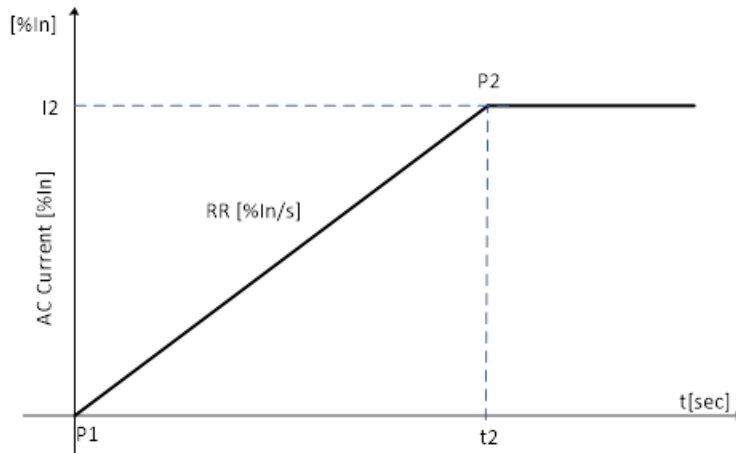

- Normal Ramp rate is defined as a slope measured in percentage of AC nominal current per second [%In/sec].
- Default Normal Ramp Rate value is 50 [%In/sec] with an adjustability range from 1 to 100 [%In/sec].

Parameter	AC Current per second [%In/s]	
	Default	Range
Ramp Rate	50	1 to 100

Parameter	Time [s]		AC Current [%In]	
	Default	Range	Default	Range
Point P1	0	N/A	0	N/A
Point P2	2	N/A	100	N/A

Reconnection (Soft-Start) Ramp Rate

Upon starting up, returning to service, or re-connecting, the Conext XW Pro limits the rate of exported/generated active power to no larger than the Ramp Rate setting.

Normal Ramp Rate function is enabled by default.

Figure 65 Reconnection ramp rate

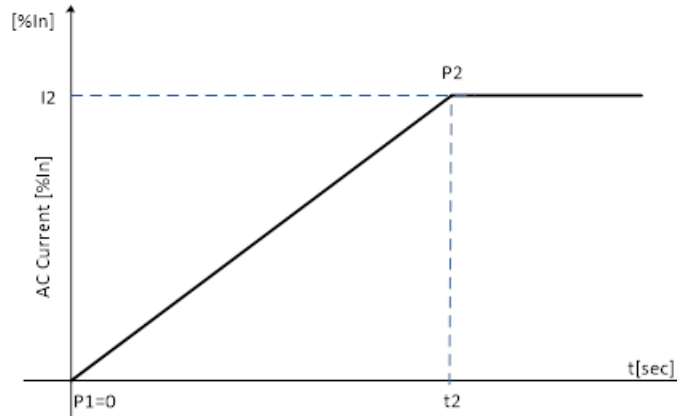

- Normal Ramp rate is defined as a slope measured in percentage of AC nominal current per second [%In/sec].
- The default Normal Ramp Rate value is 2 [%In/sec] with an adjustability range from 1 to 100 [%In/sec].

Parameter	AC Current per second [%In/s]	
	Default	Range
Ramp Rate	2	N/A

Parameter	Time [s]		AC Current [%In]	
	Default	Range	Default	Range
Point P1	0	N/A	0	N/A
Point P2	50	1 to 100	100	N/A

Grid Disconnect Settings

The Conext XW Pro will remain connected to the utility grid as long as voltage and frequency are within the qualified range (i.e. less than the Over Voltage/Frequency limit and higher than the Under Voltage/Frequency limit).

PREPA implements voltage and frequency disconnect limits via High/Low Voltage Ride Through (H/LVRT) and via High/Low Frequency Ride Through (H/LFRT) curves.

Grid voltage and frequency disconnect settings are defined in the table below, and take effect only when the H/LVRT and H/LFRT curves are disabled.

Table 78 PREPA Grid Disconnect Settings

Anti-Islanding Disconnect Slow Delay	The disconnection time delay for the grid voltage exceeding an over-voltage voltage level, but lower than the fast disconnection level. The default value for this setting is 0.5 seconds.
Anti-Islanding Disconnect Over Frequency	The frequency above which the Conext XW Pro will stop export of power and record an islanding fault. The default value for this setting is 62Hz. The disconnect will occur if the inverter is over frequency for 0.1 seconds.
Anti-Islanding Disconnect Under Frequency	The frequency below which the Conext XW Pro will stop export of power and record an islanding fault. The default value for this setting is 57 Hz, and the disconnect will occur if the inverter is under frequency for 0.1 seconds.
Anti-Islanding Disconnect Over Voltage L-N Fast	The line-to-neutral voltage above which the Conext XW Pro will stop export of power and record an islanding fault. The default value for this setting is 144 V.
Anti-Islanding Disconnect Over Voltage L-N Slow	The line-to-neutral voltage above which the Conext XW Pro will stop export of power and record an islanding fault. The default value for this setting is 132 V, and the disconnect will occur if the inverter is over frequency for 0.5 seconds.
Anti-Islanding Disconnect Over Voltage L1-L2 Fast	The line-to-line voltage above which the Conext XW Pro will stop export of power and record an islanding fault. The default value for this setting is 288 V.
Anti-Islanding Disconnect Over Voltage L1-L2 Slow	The line-to-line voltage above which the Conext XW Pro will stop export of power and record an islanding fault. The default value for this setting is 264 V, and the disconnect will occur if the inverter is over voltage for 0.5 seconds.
Anti-Islanding Disconnect Under Voltage L-N Fast	The line-to-neutral voltage below which the Conext XW Pro will stop export of power and record an islanding fault. The default value for this setting is 54 V.
Anti-Islanding Disconnect Under Voltage L-N Slow	The line-to-neutral voltage below which the Conext XW Pro will stop export of power and record an islanding fault. The default value for this setting is 72 V, and the disconnect will occur if the inverter is under frequency for 0.5 seconds.
Anti-Islanding Disconnect Under Voltage L1-L2 Fast	The line-to-line voltage below which the Conext XW Pro will stop export of power and record an islanding fault. The default value for this setting is 108 V.

Anti-Islanding Disconnect Under Voltage L1-L2 Slow	The line-to-line voltage below which the Conext XW Pro will stop export of power and record an islanding fault. The default value for this setting is 144 V, and the disconnect will occur if the inverter is under frequency for 0.5 seconds.
Transient Over-Voltage (TrOV) trip time	The disconnection time delay for the grid voltage exceeding the TrOV Trip level. The default value for this setting is 0.016 seconds.
Transient Over-Voltage (TrOV) trip level	When Transient Over-Voltage is enabled, grid voltage in percentage of nominal value [%Vn], above which the Conext XW Pro will stop operating after the TrOV trip time. The default value is 120 [%Vn].

Table 79 PREPA Grid Disconnect default and adjustability range settings

Parameter	Default	Range	Unit
Anti-Islanding Disconnect Slow Delay	0.5	0.2 to 10	[s]
Anti-Islanding Disconnect Over Frequency	61.5	62 to 64	[Hz]
Anti-Islanding Disconnect Under Frequency	57.5	53 to 57	[Hz]
Anti-Islanding Disconnect Over Voltage LN Fast	144	138 to 150	[V]
Anti-Islanding Disconnect Over Voltage LN Slow	132	120 to 138	[V]
Anti-Islanding Disconnect Over Voltage L1L2 Fast	288	276 to 300	[V]
Anti-Islanding Disconnect Over Voltage L1L2 Slow	264	240 to 276	[V]
Anti-Islanding Disconnect Under Voltage LN Fast	54	0 to 60	[V]
Anti-Islanding Disconnect Under Voltage LN Slow	72	60 to 96	[V]
Anti-Islanding Disconnect Under Voltage L1L2 Fast	108	0 to 120	[V]
Anti-Islanding Disconnect Under Voltage L1L2 Slow	144	120 to 192	[V]
TrOV trip time	16	10 to 200	[ms]
TrOV trip level	120	100 to 150	[%Vn]

Grid Reconnect Settings

At initial start-up or upon disconnection, the Conext XW Pro will remain offline until the voltage and frequency are within the qualified range (i.e. less than Over Voltage/Frequency limit and higher than Under Voltage/Frequency limit).

Table 80 PREPA Grid Reconnection default and adjustability range settings

Parameter	Default	Range	Unit
Anti-Islanding Reconnect Time	300	15 to 300	[s]
HF Reconnect Frequency	60.5	60.1 to 61	[Hz]
LF Reconnect Frequency	59.3	58 to 59.9	[Hz]
HV Reconnect Nominal Voltage	105.83	100 to 110	[%Vn]
LV Reconnect Nominal Voltage	88.33	88 to 100	[%Vn]

Anti-Islanding Reconnect Time	Grid reconnection time delay at initial start-up or upon disconnection. The default value for this setting is 300 seconds.
HF Reconnect Frequency	The frequency below which the Conext XW Pro will initialize grid reconnection process. The default value for this setting is 60.5 Hz.
LF Reconnect Frequency	The frequency above which the Conext XW Pro will initialize grid reconnection process. The default value for this setting is 59.3 Hz).
HV Reconnect Voltage	The voltage below which the Conext XW Pro will initialize grid reconnection process. The default value for this setting is 105.83 [%Vn] (percentage of nominal voltage).
LF Reconnect Voltage	The voltage above which the Conext XW Pro will initialize grid reconnection process. The default value for this setting is 88.33 [%Vn] (percentage of nominal voltage).

7 Defaults

What's in This Chapter?

Default Settings **184**

Default Settings

This section contains the default configuration settings and ranges for the Conext XW Pro. Configuration settings can be viewed and changed using the Conext Gateway web application.

Controls Settings Menu

Item	Default Setting	Range	Step Size
Operating Mode	Standby	Standby/Operating	n/a
Inverter Enable/Disable	Enabled	Enabled/Disabled	n/a
Grid Support Sell Enable/Disable	Enabled	Enabled/Disabled	n/a
Charger Enable/Disable	Enabled	Enabled/Disabled	n/a

Inverter Settings Menu

Item	Default Setting	Range	Step Size
Low Battery Cut Out	44 V	36–48 V	0.1
LBCO Hysteresis	2 V	0-10 V	0.1
LBCO Delay	10s	0–600s	1
High Battery Cut Out	65 V	58–70 V	0.1
High SOC Cut Out	99%	0–100%	1
High SOC Cut Out Delay	60s	0–300s	1
Low Battery Cut Out SOC	25%	0–100%	1
Low Battery Cut Out SOC Delay	60s	0–300s	1
Search Mode	Disabled	Enabled/Disabled	n/a
Search Watts	50 W	25–255 W	5
Search Delay	2s	1–25s	1
Action on Communication Loss	Heartbeat Disabled	Heartbeat Disabled Do Nothing Autonomous Operation AC Passthrough	n/a

Charger Settings Menu

Item	Default Setting	Range	Step Size
Battery Type	Flooded	Flooded, Gel, AGM, Custom, Li-Ion	n/a
Battery Capacity	440 Ah	0–10000 Ah ^a	1
Maximum Charge Rate	100%	5–100%	1
Maximum Bulk Charge Current	140 A	10–140 A	1
Maximum Absorption Charge Current	140 A	10–140 A	1
Maximum Float Charge Current	140 A	10–140 A	1
Charge Cycle	2-Stage	2-Stage, 3-Stage, External BMS	n/a
Default Batt Temp	Warm	Cold, Warm, Hot	n/a
Recharge Volts	50 V	40.0–54.0 V	0.1
Absorption Time	180 min	1–480 min	1
Charge Block Start	12:00 AM	12:00 AM–11:59 PM, 00:00–23:59	1
Charge Block Stop	12:00 AM	12:00 AM–11:59 PM, 00:00–23:59	1
Equalize Support	Allowed	Allowed/Disallowed	n/a
Equalize Voltage Set Point	64.0 V	54.0–64.0 V	0.1
Bulk/Boost Voltage Set Point	57.6 V (Flooded) 56.8 V (Gel) 57.2 V (AGM)	40.0–64.0 V	0.1
Absorption Voltage Set Point	57.6 V (Flooded) 56.8 V (Gel) 57.2 V (AGM)	40.0–64.0 V	0.1
Float Voltage Set Point	54.0 V (Flooded) 55.2 V (Gel) 53.6 V (AGM)	40.0–64.0 V	0.1

^aSetting the battery capacity to 0 will reset the charging current to its default values. Zero Ah battery capacity implies there is no absorption exit current criteria and absorption only exits when the absorption timer (default 3 hrs, range 1 min–8 hr) expires.

Item	Default Setting	Range	Step Size
Battery Temperature Coefficient	108 mV/°C (Flooded, Gel) 84 mV/°C (AGM)	0–180 mV/°C	1
Maximum Discharge Current	150 A	20–500 A	1
Maximum Discharge Time Interval	8s	1–300s	1
Bulk Termination Voltage	54 V	40.0–54.0 V	0.1
Bulk Termination Time	1s	1–3600s	1
Absorption Period Timeout	480 min	1–1440 min	1
Recharge SOC	50%	0–100%	1
Recharge SOC Delay	60s	0–300s	1
EPC Maximum Charge Power	6800 W	0–6800 W	1

AC Settings Menu

Item	Default Setting		Range		Step Size
	120 VAC	240 VAC	120 VAC	240 VAC	
AC Priority	AC1		AC1, AC2		n/a
AC1 Breaker Size	60 A		3–60 A		1
AC1 Low Voltage	106 V	212 V	60–115 V	156–230 V	1
AC1 High Voltage	135 V	270 V	125–144 V	250–288 V	1
AC1 Low Frequency	55 Hz		44–59 Hz		1
AC1 High Frequency	65 Hz		44–70 Hz		1
AC1 Transfer Switch Delay	12s		10–655s		1
AC2 Breaker Size	60 A		3–60 A		1
AC2 Low Voltage	80 V	160 V	60–115 V	120–230 V	1
AC2 High Voltage	138 V	276 V	125–144 V	250–288 V	1
AC2 Low Frequency	54 Hz		44–58 Hz		1
AC2 High Frequency	65 Hz		44–70 Hz		1

Item	Default Setting		Range		Step Size
	120 VAC	240 VAC	120 VAC	240 VAC	
AC2 Transfer Switch Delay	36s		10-655s		1

Grid Support Menu

Item	Default	Range	Step Size
Grid Support	Disabled	Enabled/Disabled	n/a
Grid Supp Volts	53.0 V ^b	42.0-70.0 V	0.1
Max Sell Amps ^c	26 A	0-27 A	1
Load Shave	Disabled	Enabled/Disabled	n/a
Load Shave Amps	48 A	0-48 A	1
Load Shave Start ^d	12:00 AM	12:00 AM-11:59 PM, 00:00-23:59	1
Load Shave Stop	12:00 AM	12:00 AM-11:59 PM, 00:00-23:59	1
Sell Block Start	12:00 AM	12:00 AM-11:59 PM, 00:00-23:59	1
Sell Block Stop	12:00 AM	12:00 AM-11:59 PM, 00:00-23:59	1
AC PV Charge SOC	90%	0-100%	1
State of Charge Control	Disabled	Enabled/Disabled	n/a
Grid Support SOC	Disabled	Enabled/Disabled	n/a
Grid Support SOC Exit Delay	600s	0-300s	1
EPC Maximum Discharge Power	6500 W	0-6500 W	1

^bThe setting for Grid Supp Volts must be greater or equal to LBCO+2 V. For example, if LBCO is 44 V then the minimum Grid Supp Volts is 46 V.

^cThis setting is restricted to the selected external AC1 breaker size.

^dWhen Load Shaving is enabled, if Load Shave Start and Load Shave Stop are set to the same time, the Conext XWPro load shaves continuously.

Generator Support Menu

Setting	Default	Range	Step Size
Generator Support Enable	Disabled	Enabled/Disabled	n/a
Generator Support Amps	48.0 A	0–48.0 A	1

Auxiliary Menu

Item	Default	Range	Step Size
Auxiliary Output Active Level	Active High	Active Low/ Active High	n/a
Auxiliary Output Trigger Source	Low Battery Voltage	Low Battery Voltage High Battery Voltage Low Battery Temperature High Battery Temperature Fault Bulk Exit Absorption Exit Heat Sink Overtemperature Battery Low SOC Time of Day	n/a
Low Battery Trigger Set	44 V	40.0–58.0 V	0.1
Low Battery Trigger Set Delay	1.0s	0–600.0s	1
Low Battery Trigger Clear	48 V	40.0–58.0 V	0.1
Low Battery Trigger ClearDelay	1.0s	0–600.0s	1
High Battery Trigger Set	56 V	48.0–70.0 VDC	0.1
High Battery Trigger Set Delay	1.0s	0–600.0s	1
High Battery Trigger Clear	52 V	48.0–70.0 V	0.1

Item	Default	Range	Step Size
High Battery Trigger Clear Delay	1.0s	0–600.0s	1
Low Temperature Trigger Set	0.0°C	-30.0–10.0°C	1
Low Temperature Trigger Set Delay	1.0s	0–600.0s	1
Low Temperature Trigger Clear	5°C	-30.0–10.0°C	1
Low Temperature Trigger Clear Delay	1.0s	0–600.0s	1
High Temperature Trigger Set	45°C	30.0–60.0°C	1
High Temperature Trigger Set Delay	1.0s	0–600.0s	1
High Temperature Trigger Clear	35°C	30.0–60.0°C	1
High Temperature Trigger Clear Delay	1.0s	0–600.0s	1
Heat Sink High Temperature Trigger Set	100°C	-30.0–120.0°C	1
Heat Sink High Temperature Trigger Set Delay	1.0s	0–600.0s	1
Heat Sink High Temperature Trigger Clear	95°C	-30.0–120.0°C	1
Heat Sink High Temperature Trigger Clear Delay	1.0s	0–600.0s	1
Auxiliary Output Trigger Block Start	12:00 AM	12:00 AM–11:59 PM, 00:00–23:59	1
Auxiliary Output Trigger Block End	12:00 AM	12:00 AM–11:59 PM, 00:00–23:59	1
State of Charge Start	25%	0–100%	1
State of Charge Stop	90%	0–100%	1

Item	Default	Range	Step Size
State of Charge Start Delay	1.0s	0-600.0s	0.1
State of Charge Stop Delay	1.0s	0-600.0s	0.1

Multi-unit Configuration Menu

Item	Default	Range	Step Size
Inverter Mode	Split Phase Master	Invalid Single Phase Stand Alone Master Slave Split Phase Stand Alone Master Slave Two Phase Phase 1 Master Phase 1 Slave Phase 2 Master Phase 2 Slave Three Phase Stand Alone Master Slave Phase 1 Master Phase 1 Slave Phase 2 Master Phase 2 Slave Phase 3 Master Phase 3 Slave	n/a

Associations Menu

Item	Default	Range	Step Size
AC1 Association (Grid)	Grid 1	None Grid 1-10 Generator 1-10	n/a
AC2 Association (Generator)	Generator 1	None Generator 1-10 Grid 1-10	n/a
AC Output Association (Loads)	AC Load 1	AC Load 1-10	n/a
Battery Association	House Battery Bank 1	House Battery Bank 1-5	n/a

Advanced Features Menu

Item	Default	Range	Step Size
Remote Power Off	Disabled	Enabled/Disabled	n/a
Power Save	Disabled	Enabled/Disabled	n/a
Sell Delay 40 sec	Disabled	Enabled/Disabled	n/a
Generator Support Plus	Disabled	Enabled/Disabled	n/a
AC Coupling	Enabled	Enabled/Disabled	n/a
Battery Energy Balance	Disabled	Enabled/Disabled	n/a
Peak Load Shaving Delay	Disabled	Enabled/Disabled	n/a
External Transfer Contactor	Disabled	Enabled/Disabled	n/a
External Load Switch	Disabled	Enabled/Disabled	n/a

For an explanation of these features, see *"Advanced Features"* on page 87.

Advanced Device Settings Menu

Item	Default	Range	Step Size
Periodic Transmit Enable	Enabled	Enabled/Disabled	n/a
Identify Enable	Disabled	Enabled/Disabled	n/a

Battery Management Systems Menu

Item	Default	Range	Step Size
Fault on loss of BMS status information	Disabled	Enabled/Disabled	n/a
BMS Status Lost Fault Trip time	7s	0–200s	1
Charge Voltage Limit	40.0 V	40.0–72.0 V	0.1
Discharge Voltage Limit	72.0 V	40.0–72.0 V	0.1
Charge Current Limit	0 A	0–140.0 A	0.1
Discharge Current Limit	0 A	0–140.0 A	0.1
Charge Overcurrent Offset	5.0 A	0–100.0 A	0.1
Charge Overcurrent Trip Time	2s	0–900s	1
Discharge Overcurrent Offset	5.0 A	0–100.0 A	0.1
Discharge Overcurrent Trip Time	2s	0–900s	1
DC Undervoltage Offset	3.0 V	0–10.0 V	0.1
DC Undervoltage Trip Time	10s	0–60s	1
DC Overvoltage Offset	1.0 V	0–10.0 V	0.1
DC Overvoltage Trip Time	5s	0–60s	1
Fault on loss of State of Charge information	Disabled	Enabled/Disabled	n/a

Device Instance Menu

Item	Default	Range	Step Size
Device Number	0	0-247	1
Device Name	XW6848-21	Alphanumeric characters and spaces only	n/a
System Instance	0	0-255	1

Modbus Settings Menu

Item	Default	Range	Step Size
Modbus Slave Address (Port 502)	10	2-246	1
Modbus Slave Address (Port 503)	10	2-246	1

Schneider Electric

As standards, specifications, and designs change from time to time, please ask for confirmation of the information given in this publication.

For other country details please contact your local Schneider Electric Sales Representative or visit the Schneider Electric Solar Business website at: <https://solar.schneider-electric.com>

© 2020 Schneider Electric. All Rights Reserved.

QR CODE

