

INSTALLATION AND OPERATION MANUAL

L-G4.X SOLAR MODULES

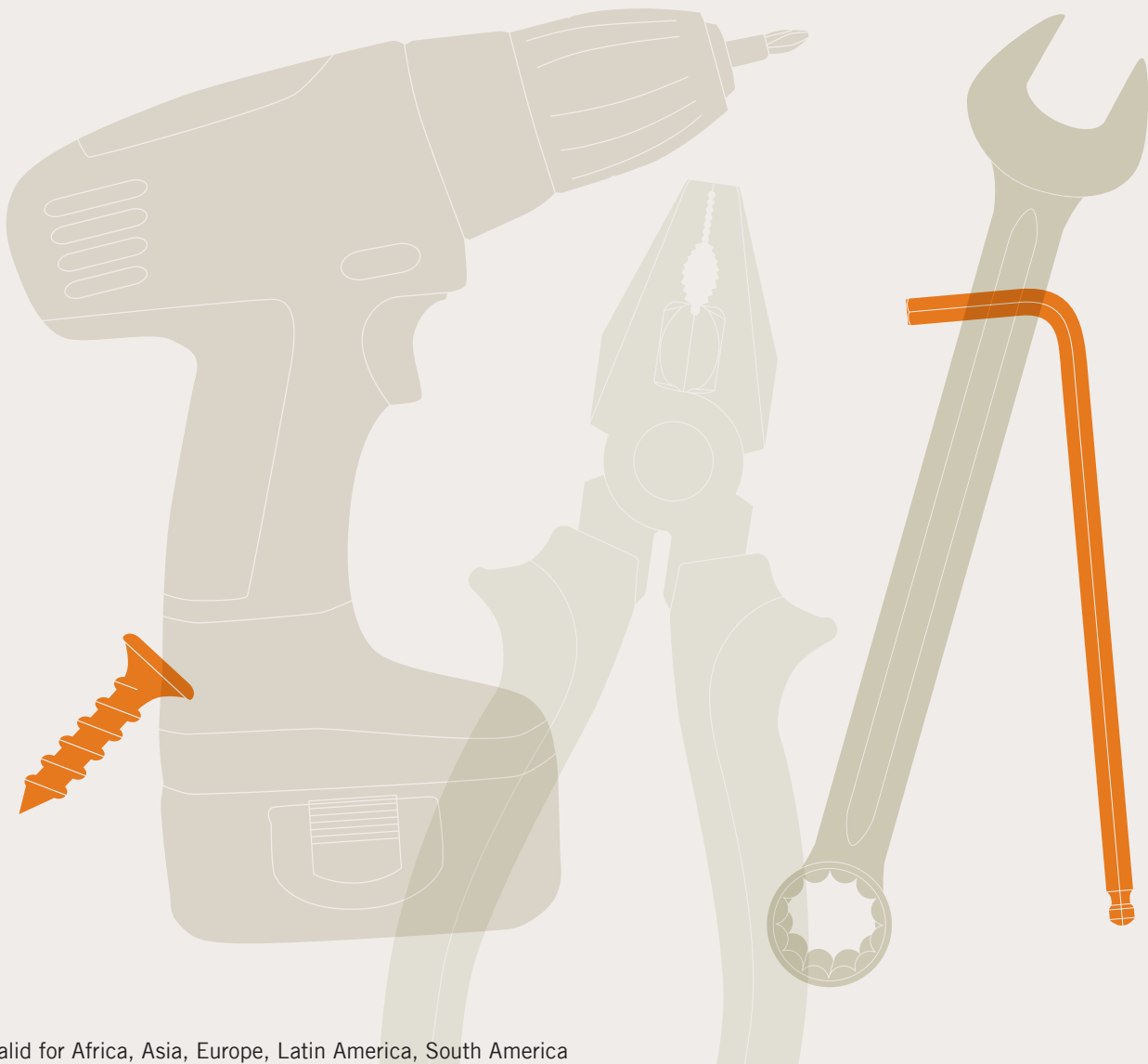

Valid for Africa, Asia, Europe, Latin America, South America

TABLE OF CONTENTS

1	INTRODUCTION	3
2	PLANNING	5
2.1	Technical specifications	5
2.2	Requirements	6
2.3	Mounting options	7
2.4	Electrical layout	10
3	INSTALLATION	11
3.1	Safety and transport	11
3.2	Preparation of installation	13
3.3	Module installation	14
4	ELECTRICAL CONNECTION	15
4.1	Safety	15
4.2	Electrical installation safety	16
4.3	Connection of modules	17
4.4	After installation	18
5	GROUNDING	19
6	FAULTS AND DEFECTS	19
7	DISPOSAL	19
8	MAINTENANCE AND CLEANING	20

DOCUMENT REVISION 01

This Manual is valid for Africa, Asia, Europe, Latin America, and South America as of December 1st 2016 for Q.PRO L-G4.1, Q.PRO L-G4.2, Q.PLUS L-G4.1, Q.PLUS L-G4.2, Q.PEAK L-G4.1, Q.PEAK L-G4.2 solar modules, and replaces all earlier versions.

DISCLAIMER

Technical parameters and the design are subject to change. The data sheets and customer information valid at the point in time when the relevant module was manufactured apply to the installation, mounting, and maintenance procedures for the respective solar modules.

With solar modules from Hanwha Q CELLS GmbH (hereafter referred to as "Q CELLS") you can directly transform the sun's limitless energy into environmentally-friendly solar electricity.

In order to ensure the maximum performance of your Q CELLS solar modules, please read the following instructions carefully and observe all guidelines. Non-compliance may result in damage and/or physical injury.

This installation and operation manual (hereafter also referred to as the "Manual") provides instructions for the safe installation and operation of crystalline solar modules.

- ➔ Please read these instructions carefully before proceeding with your installation.
- ➔ Please retain these instructions for the life of the solar modules.
- ➔ Please ensure that this Manual is available to the operator at all times.
- ➔ This Manual should be given to all subsequent owners or users of the solar modules.
- ➔ All supplements received from the manufacturer should be included.
- ➔ Please observe all other applicable documents.
- ➔ If your questions are not satisfactorily answered in the manual, please contact your system supplier.

Additional information can be found on our website at www.q-cells.com.

Intended Use

This manual is valid for Africa, Asia, Europe, Latin America, and South America. These instructions contain information regarding the safe handling and use of quality crystalline solar modules from Q CELLS and for their installation, mounting, wiring, maintenance and disposal.

Symbols and Labels

The following symbols and labels are used throughout the Manual for ease of use.

SYMBOL	DESCRIPTION
➔	Procedure with one or more steps.
•	Lists of items.
✓	Ensure that when carrying out a procedure, you check the results of said procedure.
⊘	Prohibited.



Beware of possible danger or damage. Categories:

- Danger: Risk of fatal injury
- Attention: Risk of serious injury or damage to property
- Note: Risk of damage to product

Safety Regulations

In particular the installer as well as the operator of a module is responsible for compliance with all applicable statutory requirements and regulations.

- ➔ Unless otherwise specified by any laws or regulations, the following stipulations must be upheld at all times during the installation, operation, and maintenance of the solar modules:
 - This manual.
 - Other applicable stipulations (such as country-specific regulations for pressure equipment, operational safety, hazardous goods, and environmental protection).
 - Regulations and requirements specific to the system.
 - Any applicable laws and requirements, in particular international, country specific, regional laws and stipulations governing the planning, installation, and operation of solar power systems and work on roofs.
 - Any valid international, national and regional regulations governing work with direct current, especially those applicable to the installation of electrical devices and systems, and regulations issued by the respective energy provider governing the parallel operation of solar power systems.
 - Any international, country specific and regional accident-prevention regulations.
 - Other applicable stipulations provided by the relevant national institutions regarding safety in the installation and operation of electrical items.

Qualified & Skilled Personnel

Both, the installer and operator are responsible for ensuring that installation (including connection to the grid), maintenance and dismantling are carried out by trained and qualified specialists with approved training certificates (issued by a state or federal organization) for the respective specialist trade.

Electrical work may only be performed by an officially certified tradesperson in accordance with the stipulations applicable in the relevant country with regard to norm and regulations (in Germany e.g. DIN norms, VDE regulations) and the stipulations of the local grid operator and/or energy provider.

Validity

These instructions are only valid for crystalline solar modules from the company Q CELLS. Q CELLS assumes no liability for damage resulting from failure to observe these instructions.

- ➔ Please observe the wiring and dimensioning of the system.
- ➔ The installer of the system is responsible for compliance with all necessary safety regulations during set-up and installation.

Q CELLS assumes no liability on the basis of these instructions. Q CELLS is only liable in the context of contractual agreements or in the context of accepted guarantees. Q CELLS accepts no other responsibility for the functionality and safety of the modules.

- ➔ Please observe the instructions for any other system components that may be part of the complete solar power system. It may be necessary to carry out a structural analysis for the entire project.

Additional information for the Operator

- ➔ Please keep this manual for the entire life of the solar power system.
- ➔ Please contact your system supplier for information concerning the formal requirements for solar power systems.
- ➔ Please be sure to contact the relevant local authorities and energy providers regarding regulations and permit requirements prior to installation of the solar power system. Your financial success depends on the fulfillment of these requirements.

Other applicable documents

In addition to this Manual following technical information are relevant:

DOCUMENT TYPE

Product data sheet

Packaging and transport information

Additional information can be found in the currently valid data sheets available at www.q-cells.com.

PRODUCT LINE	Q.PRO L-G4.1	Q.PLUS L-G4.1 / Q.PEAK L-G4.1	Q.PRO L-G4.2	Q.PLUS L-G4.2 / Q.PEAK L-G4.2
Type	Polycrystalline	Q.ANTUM	Polycrystalline	Q.ANTUM
Length	1994 mm	1994 mm	1994 mm	1994 mm
Width	1000 mm	1000 mm	1000 mm	1000 mm
Frame height	35 mm	35 mm	35 mm	35 mm
Weight	24 kg	24 kg	24 kg	24 kg
Max. system voltage V_{sys} [V]	1500 (IEC) / 1000 (UL)	1500 (IEC) / 1000 (UL)	1500 (IEC) / 1500 (UL)	1500 (IEC) / 1500 (UL)
Max. fuse rating [A]	20	20	20	20
Permissible temperature range	-40 °C to +85 °C			
Junction box protection class	≥ IP67 with by-pass diodes	≥ IP67 with by-pass diodes	≥ IP67 with by-pass diodes	≥ IP67 with by-pass diodes
Connector protection class	IP68	IP68	IP68	IP68
Fire protection class	C	C	C	C
Snow load [Pa ¹]	5400	5400	5400	5400
Wind load [Pa ¹]	2400	2400	2400	2400
Certificates	CE-compliant; IEC 61215 (Ed.2) see page 8; IEC 61730 (Ed.1) Application Class A; UL 1703			

¹ Test-load in accordance with IEC 61215

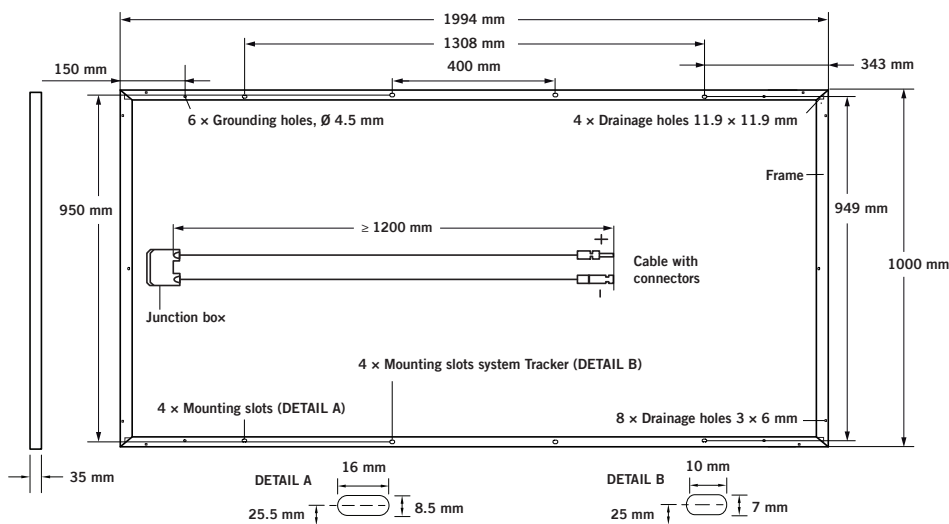

Fig. 1: External dimensions (in mm) and components for Q.PRO L-G4.1, Q.PRO L-G4.2, Q.PLUS L-G4.1, Q.PLUS L-G4.2, Q.PEAK L-G4.1, Q.PEAK L-G4.2

Installation Site

Please note the following guidelines that apply to the installation site:

- The modules have been tested according to IEC 61215 for operation in a temperate climate.
- Solar modules are not explosion-proof and are not suitable for use in explosive environments.
- ➔ Do not operate solar modules near highly flammable gas and vapors (e.g. gas tanks, gas stations).
- ➔ Do not install modules in enclosed space.
- ➔ Do not install modules in locations where they may be submerged in water for lengthy periods (e.g. floodplains).
- ➔ Do not use modules as a substitute for the normal roofing (e.g. modules are not rainproof).
- ➔ Do not install modules in close proximity to air conditioning systems
- ➔ Do not install modules above 4000 m (13.120 ft) altitude above sea level.
- ➔ Do not bring any chemical substance (e.g. oil, solvent etc.) into contact with any part of the panel. Only substances, which are released by Q CELLS, are allowed to be used during installation, operation and maintenance.

The solar modules are designed for the following applications:

- Operating temperatures from -40 °C to $+85\text{ °C}$.
- Wind loads up to max. 2,400 Pa and snow loads up to max. 5,400 Pa (Test-load in accordance with IEC 61215, see chapter 2.3 mounting options).
- Installation using a mounting frame for solar modules.

Prevention of Shadowing Effects

Optimal solar irradiation leads to maximum energy output:

- ➔ For this reason, install the modules so that they face the sun.
- ➔ Avoid shadowing (due to objects such as buildings, chimneys or trees).
- ➔ Avoid partial shading (for example through overhead lines, dirt, snow).

Mounting Frame Requirements

The Modules shall be installed and operated on mounting frames that comply with any applicable laws and stipulations as well as with the following:

- Conform to the necessary structural requirements.
- Compliant with local snow and wind loads.
- Properly fastened to the ground, the roof, or the façade.
- Forces acting on the module are relayed to the mounting substructure.
- Ensures sufficient rear ventilation of the module.
- Guarantees long-term stability.
- Avoid the usage of different metals to prevent contact corrosions.
- Allows for stress-free expansion and contraction due to temperature fluctuations.

- ➔ Ensure that no mechanical stresses (e.g., caused by vibrations, twisting, or expansion) are generated on the module.
- ➔ Ensure that the clamps and the mounting frame are compatible.

Clamp System Requirements

Use customary clamps that satisfy the following requirements:

- Clamp width: $\geq 38\text{ mm}$.
- Clamp height compliant with a 35 mm frame height.
- Clamp depth: 5–12 mm.
- Clamps are not in contact with the front glass.
- Clamps do not deform the frame.
- Clamps that satisfy the structural requirements of the installation site.
- Long-term stable clamps that securely affix the module to the mounting frame.

Module Orientation Requirements

- Vertical or horizontal installation is permitted.
- ➔ Ensure that rain and melting snow can run off freely. No water accumulation.
- ➔ Ensure that the drainage holes in the frame are not covered. No sealing.

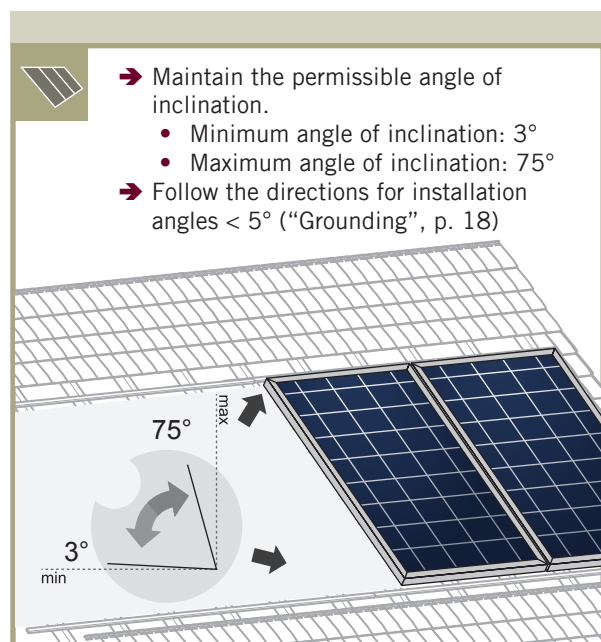
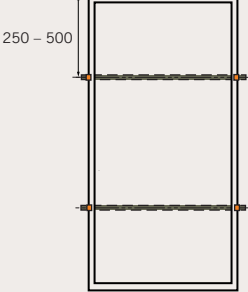
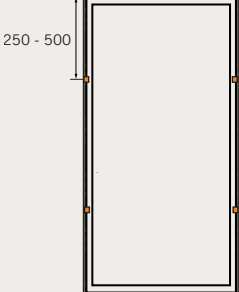
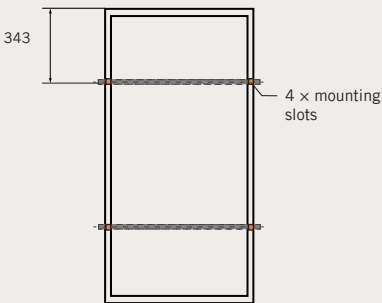
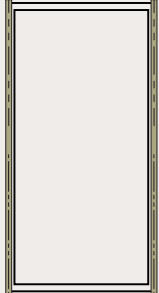

Fig. 2: Installation options for crystalline Q CELLS modules. All dimensions are given in mm. Also observe the allowed static loads and clamping range as specified on the following page. The illustrated installation options apply for both horizontal and vertical module orientation.

 Module
  Clamp
  Subconstruction
  Mounting profile

TYPE OF INSTALLATION	POINT MOUNTING SYSTEM	LINEAR MOUNTING SYSTEM
INSTALLATION WITH CLAMPS	 <p style="text-align: center;">CL1</p>	 <p style="text-align: center;">CL3</p>
INSTALLATION ON MOUNTING POINTS	 <p style="text-align: center;">FB1</p>	
INSTALLATION WITH INSERTION PROFILES	NOT PERMITTED	 <p style="text-align: center;">IP1</p>

Specifications

MODULE TYPE	MOUNTING OPTION	CLAMPING AREA ¹ [MM]	TEST-LOAD ACC. IEC 61215 PUSH/PULL [PA]
Q.PRO L-G4.1 Q.PRO L-G4.2 Q.PLUS L-G4.1 Q.PLUS L-G4.2 Q.PEAK L-G4.1 Q.PEAK L-G4.2	CL1 (4 point clamping on long side)	250-500	5400/2400
	CL3 (4 point clamping on long side)	250-500	3600/2400
	FB1 (4 screws mounting on long module side)	343	5400/2400
	IP1 (Slide-in / long module side)		3600/2400

¹ Distance between outer edge of module and middle of the clamp.

DISTANCE BETWEEN MODULES

- ➔ Maintain an interval of at least 10 mm between two modules along the short side
- ➔ Maintain an interval of at least 5 mm between two modules along the long side

MOUNTING OPTIONS CL1

- ➔ Ensure, that the subconstruction does not run below the junction box.
- ➔ Ensure, that the connection cables of the junction box don't run between laminate and substructure.

MOUNTING OPTION FB1

- ➔ Use M8 corrosion-proof screws and washers (min. diameter 16 mm).
- ➔ Ensure, that the connection cables of the junction box don't run between laminate and substructure.
 - The fastening points are located on the backside of the module frame.

Module Selection

For detailed key electrical data, please refer to the actual data sheet referring to the relevant Module (available at www.q-cells.com).

- ➔ Only connect modules of the same type and the same power class.

Safety Factor

During normal operation, a module may generate a greater current and/or higher voltage than that determined under standardized test conditions. Please use a safety factor of 1.25 for the following:

- Calculating the voltage measurement values (V_{oc}) of components
 - Calculating the current measurement values (I_{sc}) of conductors
 - Sizing of control systems connected to the outlets of the solar modules
- ➔ Please follow the valid national guidelines for the installation of electrical systems.

Series Connection

Connection of modules in series is only permitted up to the maximum system voltage as listed in the applicable data sheet of all the relevant modules to be installed.

- ➔ Take into account all possible operating situations and all relevant technical norms and regulations when designing the system. It has to be ensured that the maximum system voltage, including all necessary safety margins, is not exceeded.
- ➔ Take the voltage limit of the inverter into account when determining the maximum number of modules in the string.

Parallel Connection

Modules may be damaged by the occurrence of reverse currents (caused by module defects, ground leaks, or defective insulation).

- ➔ Ensure that the maximum reverse current load capacity indicated in the data sheet is met.

In order to limit reverse currents that may occur, we recommend using the following safety options:

1) Layout with a limited number of parallel connected strings:

Without undertaking further current blocking measures, a maximum of two module strings may be operated in parallel on an inverter or MPP tracker.

2) Layout with string fuses:

place fuses for each string of modules at the plus and minus ends. Observe the maximum permitted number of strings as indicated in the specifications provided by the respective string fuse manufacturer and the technical guidelines.

NOTE!

When installing different product versions, the lowest minimum permitted reverse current load capacity applies.

Inverters

Inverters with or without transformers may be used.



- Ensure that all personnel are aware of and adhere to accident-prevention and safety regulations.
- While working wear clean gloves.

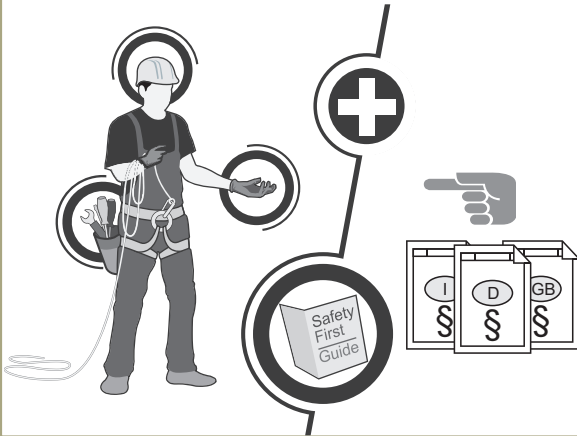

DANGER! Risk of fatal injury due to electric shock!

- Do not install damaged modules.
- Inform your distributor of any damages immediately.

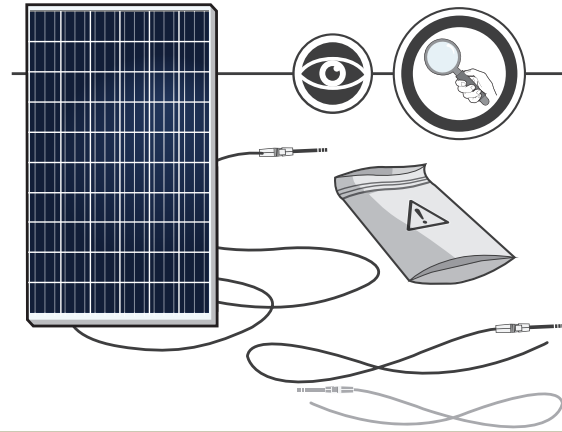

- Inspect the packaging for damages.
- Contact the transport company regarding any damage to the packaging.
- Follow any instructions on the packaging.

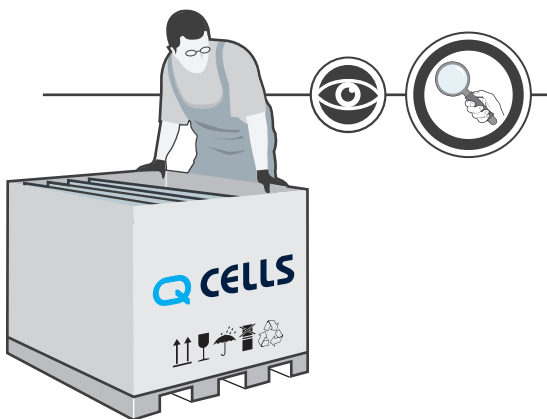

DANGER! Risk of fatal injury due to electric shock!

- Cover the modules with an opaque material during installation.

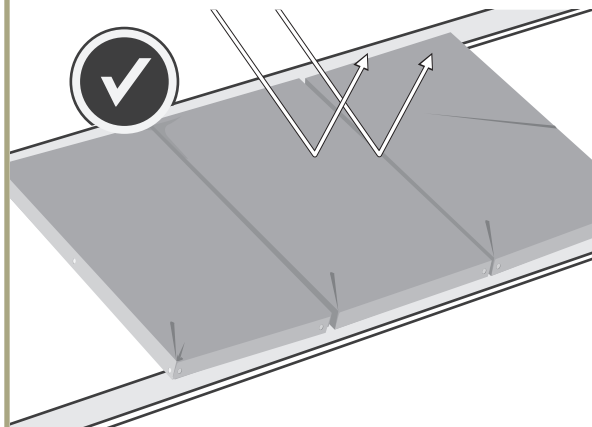

- Leave modules in their original packaging until installation.
- Store the modules securely in cool and dry rooms. The packaging is not weatherproof.

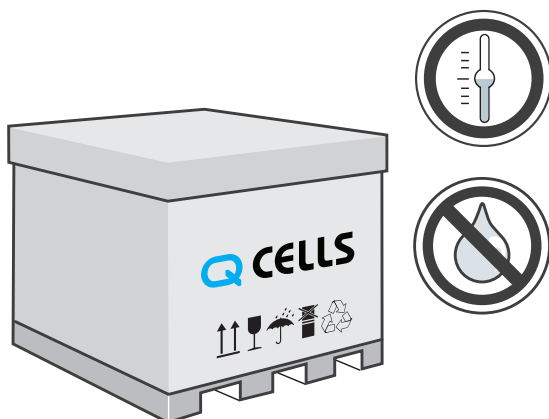

WARNING! Fire Risk!

- Do not install modules indoors.
- Do not install modules on moving objects.

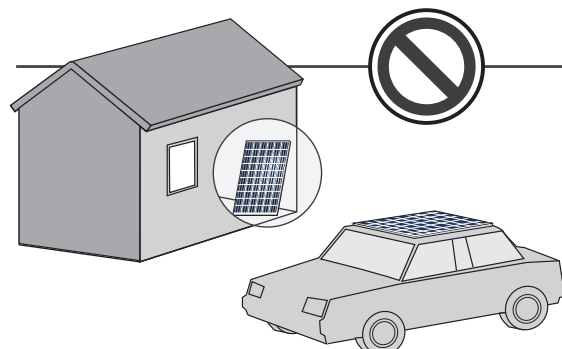

**NOTE! Module damage may occur!**

- ➔ Never lift or move the module with the connection cables or junction box.
- ➔ Carry modules upright and horizontally as shown.

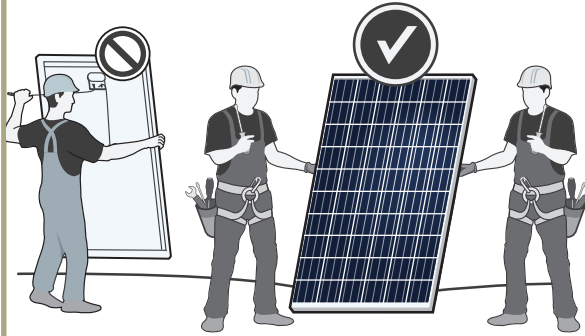
**NOTE! Module damage may occur!**

- ➔ Never step on modules.
- ➔ Do not subject modules to any mechanical stress.
- ➔ Do not allow any objects to fall onto modules

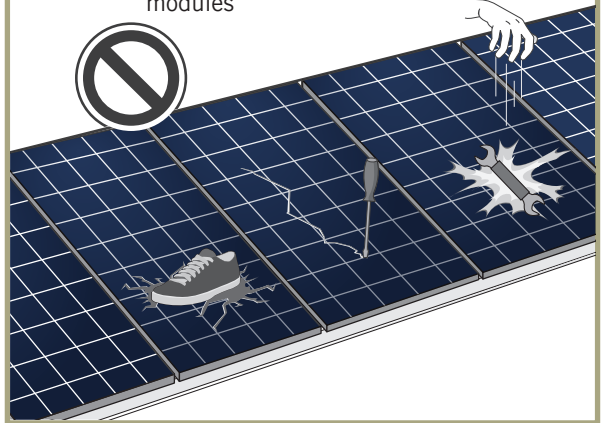
**NOTE! Module damage may occur!**

- ➔ Do not drop modules.

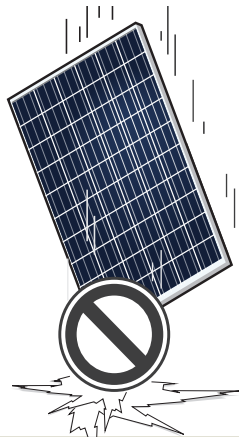
**NOTE! Module damage may occur!**

- ➔ Only make modifications to the module which have been confirmed in writing by Q CELLS.

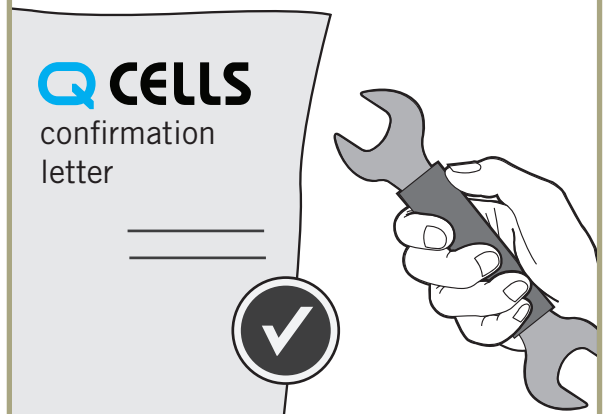
**NOTE! Module damage may occur!**

- ➔ Do not stack modules.

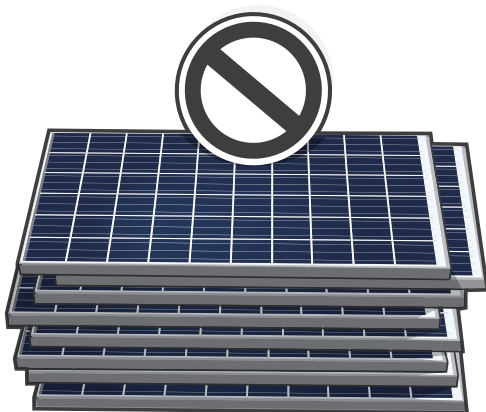
**NOTE! Module damage may occur!**

- ➔ Do not install modules near flammable gas/vapors.
- ➔ Do not install modules in close proximity to air conditioning systems.

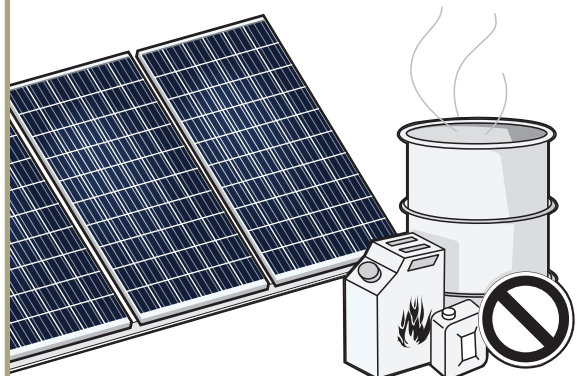



DANGER! Risk of fatal injury due to electric shock!

- ➔ Block off the installation zone.
- ➔ Keep children and unauthorized individuals away from the solar power system.

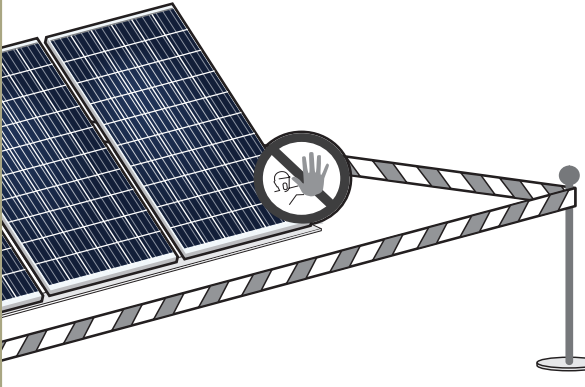

WARNING! Risk of injury due to falling modules!

- ➔ Secure modules during installation.
- ➔ Do not install modules in windy or wet weather.

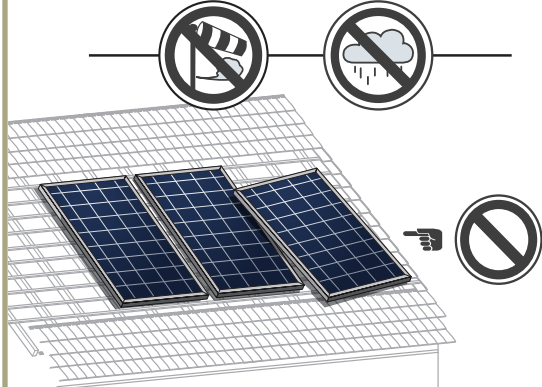

DANGER! Risk of fatal injury due to electric shock!

- ➔ Only use dry, insulated tools.

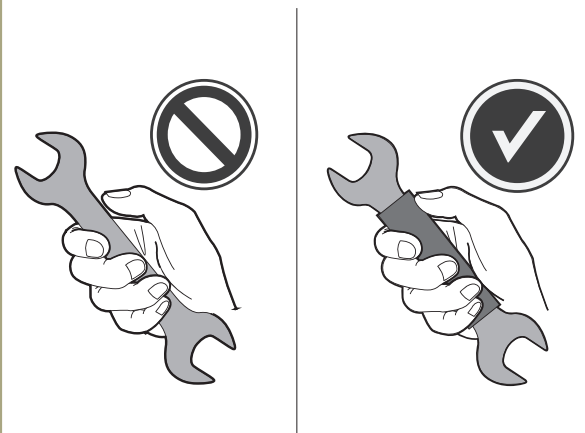

- ➔ Do not carry out the installation alone.

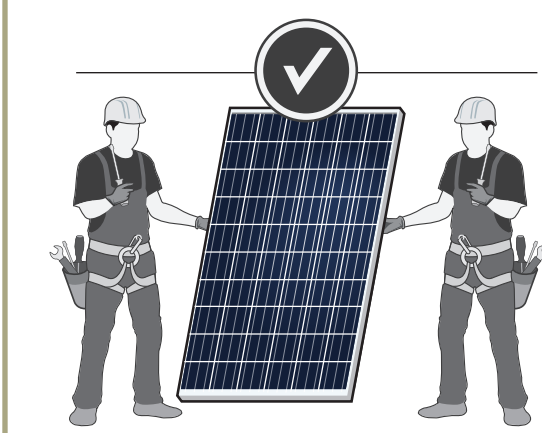

DANGER! Risk of fatal injury due to electric shock!

- ➔ Ensure that modules and tools are not subject to moisture or rain at any time during installation.

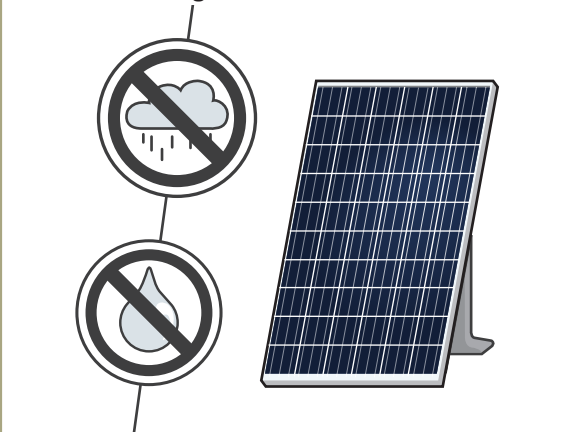

- Only install undamaged modules and components.
- ➔ Do not modify the module (e.g. do not drill any additional holes).

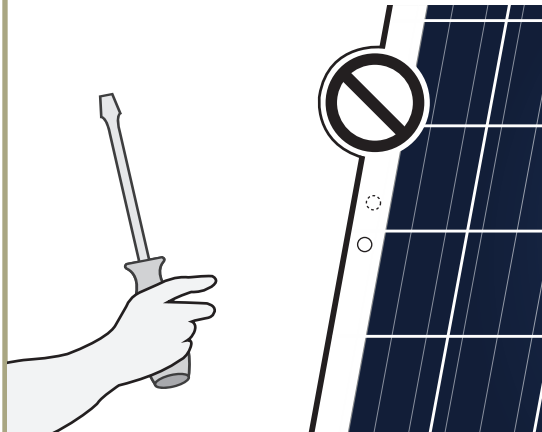

**Option 1:**

- ➔ Fasten the module with 4 clamps in the specified clamping range, see p. 7.
- ➔ Tighten clamps according to manufacturer's instructions.

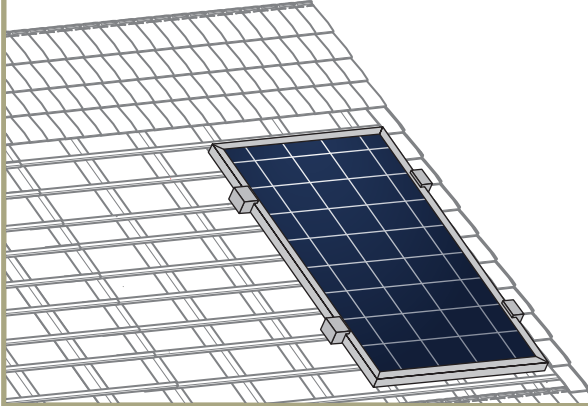

- ➔ Maintain an interval of at least 10 mm between two modules along the short side and 5 mm along the long side.

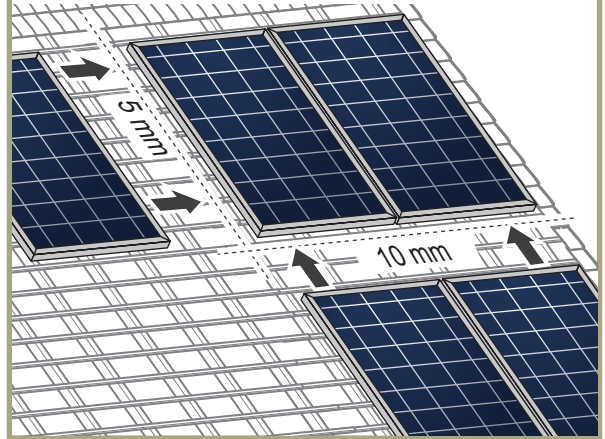
**Option 2:**

- ➔ Install the module at the 4 mounting points, see p. 7.
- ➔ Tighten clamps according to manufacturer's instructions.

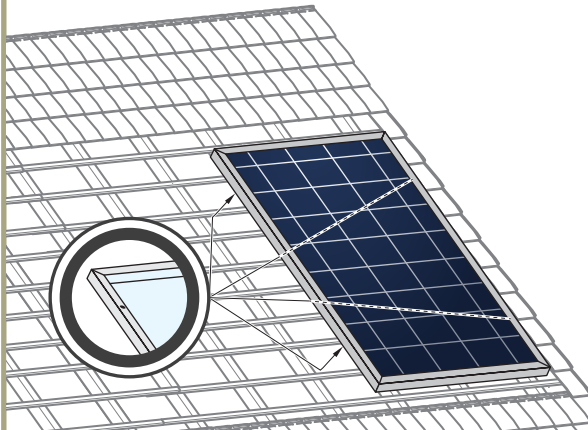
**NOTE! Module damage may occur!**

- ➔ Do not subject modules to mechanical tension. Max. torsion 10 mm/m.

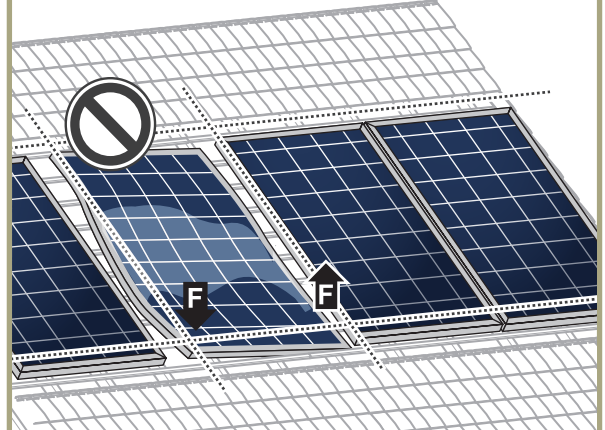
**Option 3:**

- ➔ Install the module using mounting profiles, see p. 7.

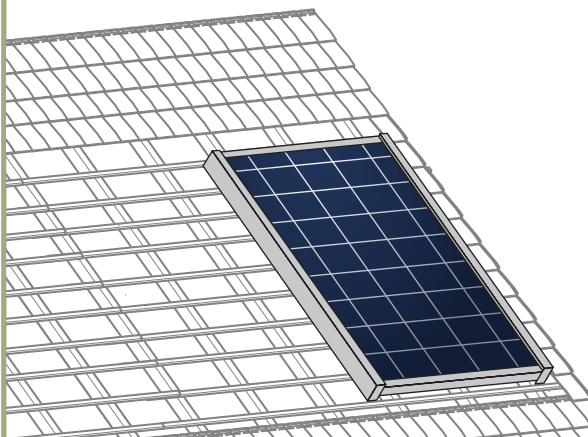

**DANGER!****Risk of fatal injury due to electric shock!**

When disconnecting an electric circuit carrying direct current, electric arcs can occur that may result in life-threatening injuries.

- ➔ Do NOT unplug the cable when under load.
- ➔ Do NOT connect any exposed cable ends.
- ➔ Do NOT touch the poles at the same time.

A solar module generates electrical current and voltage even at a low intensity of illumination. Sparks and electric arcs may result from the separation of a closed circuit. These can result in life-threatening injuries. The danger increases when several modules are connected in series.

- ➔ Please be aware of the entire open circuit voltage is active even at low levels of solar irradiation.
- ➔ Please follow the valid national regulations and safety guidelines for the installation of electrical devices and systems.
- ➔ Please make sure to take all necessary safety precautions. With module or phase voltages of more than 120 V, the extra-low voltage range is exceeded.
- ➔ Carry out work on the inverter and the wiring with extreme caution.
- ➔ Ensure that the modules are disconnected at the inverter prior to separation.
- ➔ Be sure to observe the specified time intervals after switching off the inverter. High-voltage components need time to discharge.

**DANGER! Risk of fatal injury due to electric shock!**

- ➔ Only use dry, insulated tools for electrical work.

**DANGER! Risk of fatal injury due to electric shock!**

- ➔ Never open the junction box.
- ➔ Change of bypass diodes is only allowed by qualified and trained personnel in disconnected and covered state.

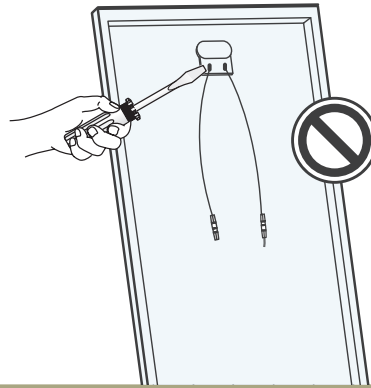
**DANGER! Risk of fatal injury due to electric shock!**

- ➔ Never touch live contacts with bare hands.
- ➔ Do not touch the poles at the same time.
- ➔ Cover connectors by suitable protective caps until installation.

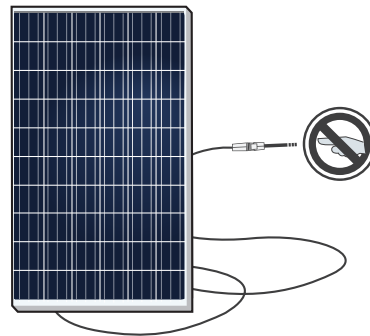
**DANGER! Risk of fatal injury due to electric shock!**

- ➔ Insulate any exposed cable ends.
- ➔ Only connect cables with plugs.

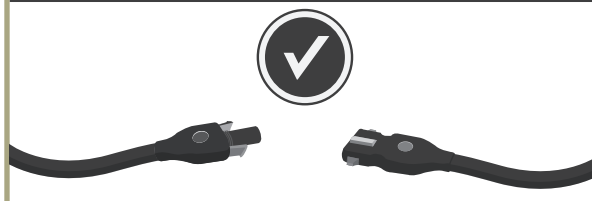
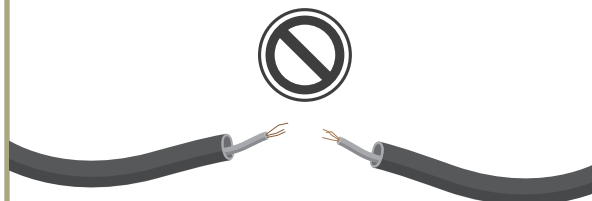



DANGER! Risk of fatal injury due to electric shock!

➔ Ensure correct polarity.

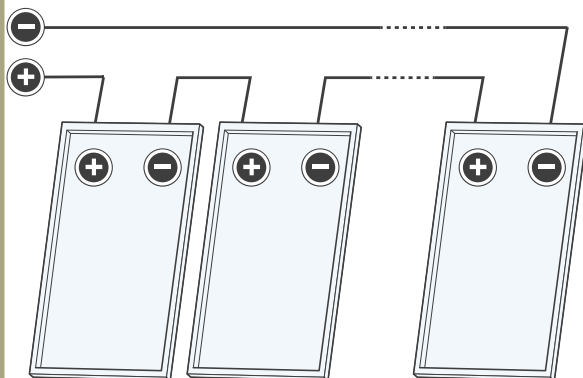

DANGER! Risk of fatal injury due to electric shock!

➔ Be sure to maintain the time intervals as specified by the inverter manufacturer between switching off the inverter and beginning any further work.

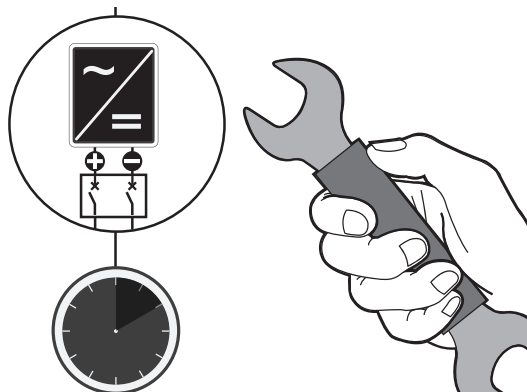

DANGER! Risk of fatal injury due to electric shock!

➔ Never unplug the cable when under load.

1. Switch off the inverter.

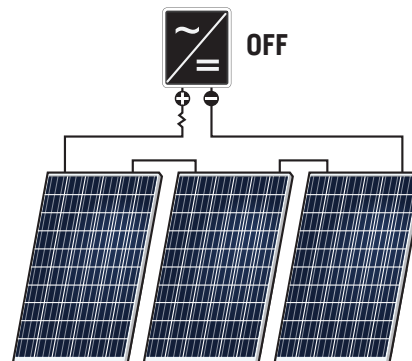

2. Cover the modules to be disconnected.

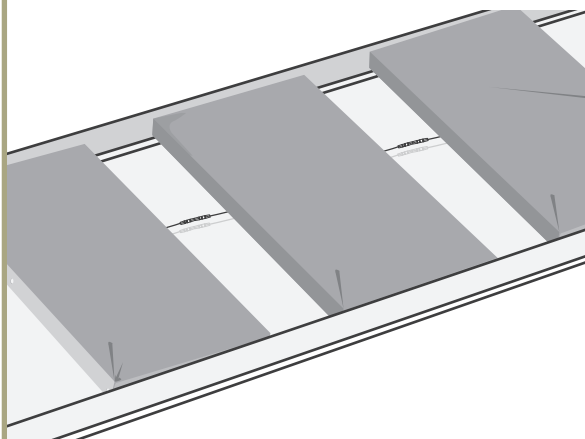

3. Switch off the DC circuit breaker.

➔ Disconnect plugs by the use of appropriate and qualified tools of the manufacturer Tyco, Amphenol or Multi-Contact.

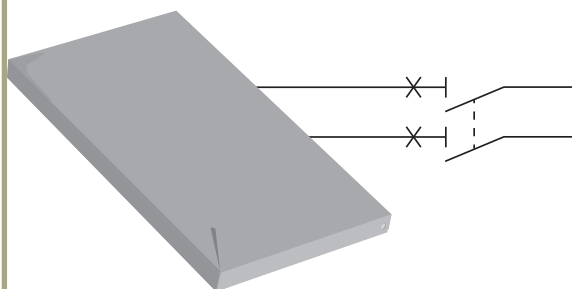



- Use solar cables for the connection at the junction box outlet.
- Use the same, inverter-compatible plugs.

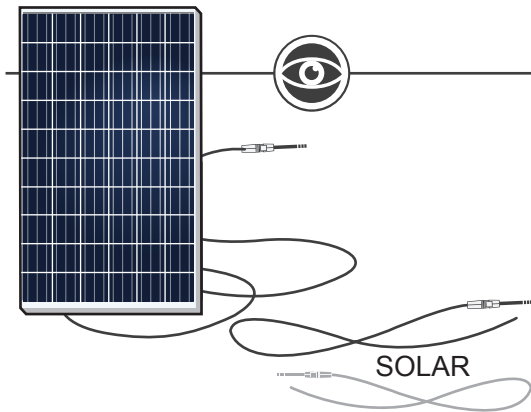

NOTE! Module damage may occur!

- Ensure that the cabling is not under stress.
- Ensure that the cables do not run between module and subconstruction (danger of pinch).

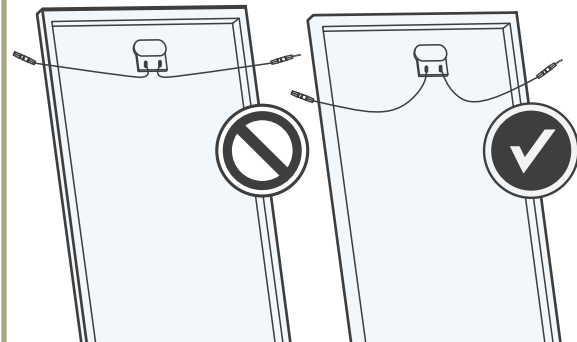

DANGER! Risk of fatal injury due to electric shock!

- Ensure that all electrical components are in a proper, dry, and safe condition.

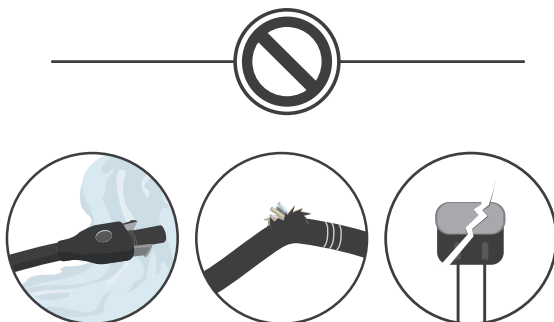

- Do not connect modules with different orientations or angles of inclination in the same string.

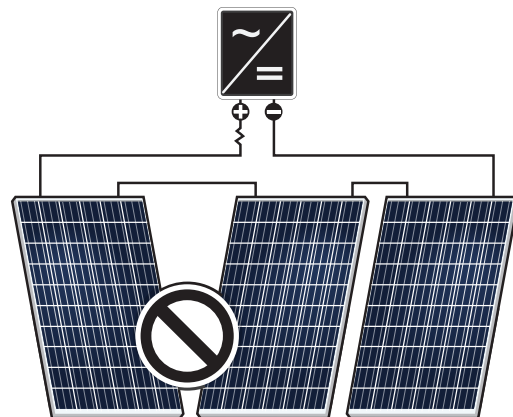

- Ensure for a tight connection between the plugs. Plugs click together audibly.

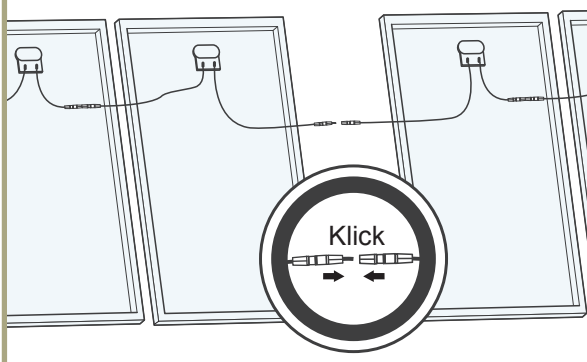

- A module with min. $\geq 1,200$ mm long cable in portrait orientation can be wired as a "2nd next neighbor"
- ① "2nd next neighbor" - Wiring without a return cable.
- ② Standard wiring with a return cable

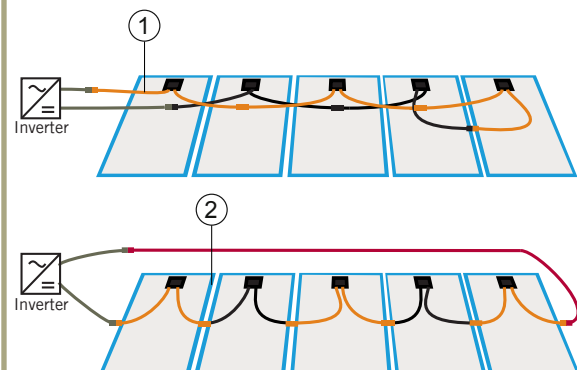



- Ensure that all necessary safety and functional tests have been carried out according to current industry standards.

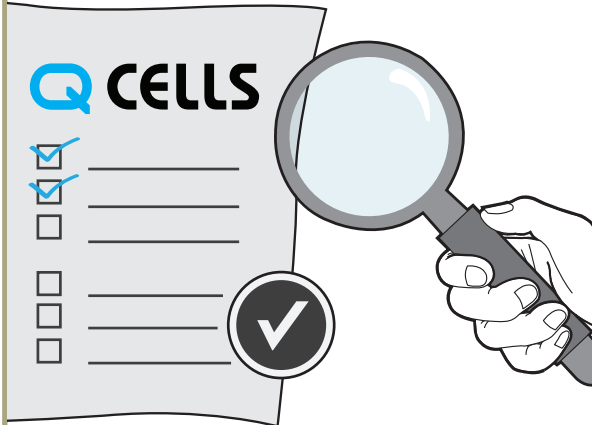

- Integrate the system into the existing lightning protection system in accordance with the applicable local regulations.

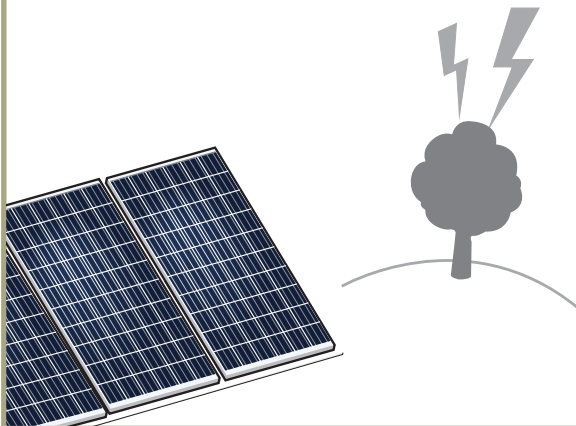

- Ensure that the cabling is not exposed and/or hanging and is protected from dirt and moisture.

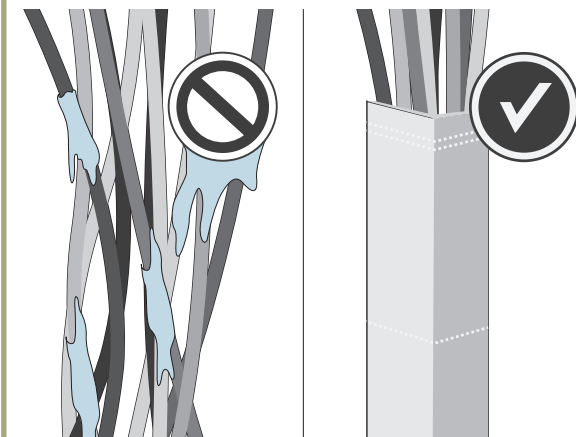

NOTE! Module damage may occur!

- Ensure that the plug connections are secured away from any water-channelling surface.

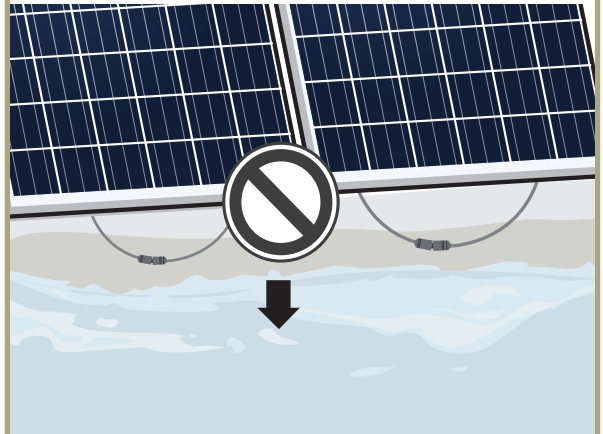

WARNING! Fire Risk!

- Do not use light concentrators (e.g. mirrors or lenses).

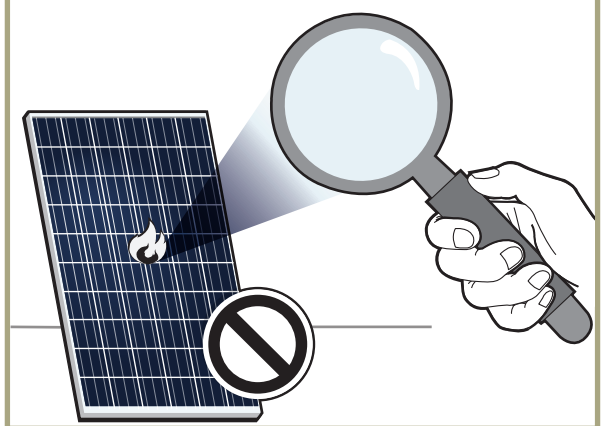

5

GROUNDING

Protective Grounding

- ➔ The modules must be grounded in accordance with the local statutory regulations.

Functional grounding

- When using an installation tilt of $<5^\circ$ a functional grounding at the negative generator connection must be implemented.
- ➔ Ensure that the difference of potential between the negative generator connection and the PE(N) of every MPP tracker of the respective inverters is 0 V.
- ➔ Follow the directions of the inverter manufacturer.
- ➔ Only use inverters which include licensed grounding kits.

6

FAULTS AND DEFECTS



DANGER!

Risk of fatal injury due to electric shock!

- ➔ Do not attempt to fix any problems yourself (e.g., glass cracks, damaged cables).
- ➔ Please contact an installer or Q CELLS Technical Customer Service Department.

7

DISPOSAL

- ➔ Do not disconnect modules by yourself.
- ➔ Please contact an installer or Q CELLS Technical Customer Service Department.
- ➔ Dispose of modules in accordance with the local disposal regulations.

Q CELLS solar modules are known for a long operating life and minimal maintenance effort and expense. Dirt and grime are usually washed away by rain. If the module is fully or partially shaded by dirt or debris (e.g., plants, bird droppings), it needs to be cleaned to prevent a loss of performance.

Maintenance

- ➔ The system should be inspected by an installer annually to check the following:
 - all system components sit securely and are corrosion free.
 - the connection is secure and all electrical components are clean and undamaged.

Cleaning



WARNING!
Risk of injury due to hot and live modules!

- ➔ Only clean modules that have cooled down.
- ➔ Do not carry or wear any electrically conductive parts.



WARNING!
Risk of falling due to unsecured access!

- ➔ Never access the installation area alone or without taking adequate security precautions.
- ➔ Please commission a trade specialist.

Clean the modules as follows:



NOTE!
Module surface damage may occur!

- ➔ Remove snow and ice carefully without force (e.g. with a very soft broom).
- ➔ Do not scratch off dirt.
- ➔ Rinse dirt (dust, leaves, etc.) off with lukewarm water or use an alcohol based glass cleaner. Do not use abrasive detergents or tensides.
- ➔ Use a soft cellulose cloth (kitchen roll) or sponge to carefully wipe off stubborn dirt. Do not use micro fleece wool or cotton cloths.

Isopropyl alcohol (IPA) can be used selectively to remove stubborn dirt and stains within one hour after emergence.

- ➔ Please follow the safety guidelines provided by the IPA manufacturer.
- ➔ Do not let IPA run down between the module and the frame or into the module edges.



NOTE! Module damage may occur!

- ➔ Do not clean modules with water if there is a risk of frost.

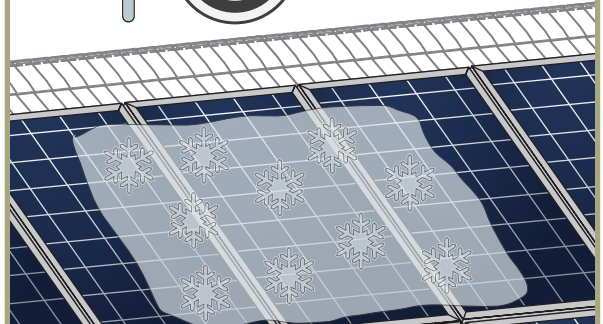
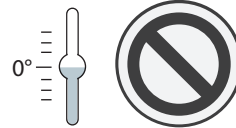

- ➔ Remove dirt with lukewarm water or alcohol based glass cleaner, a broom, or a soft cloth.
- ➔ Do not use tensides, scrapers, or any high-pressure water cleaning equipment.

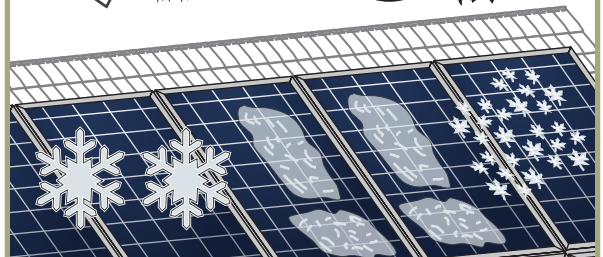
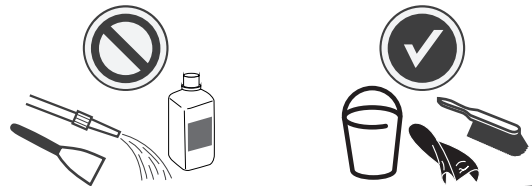

- ➔ Free the substructure from any dirt and debris (leaves, bird nests, etc.).

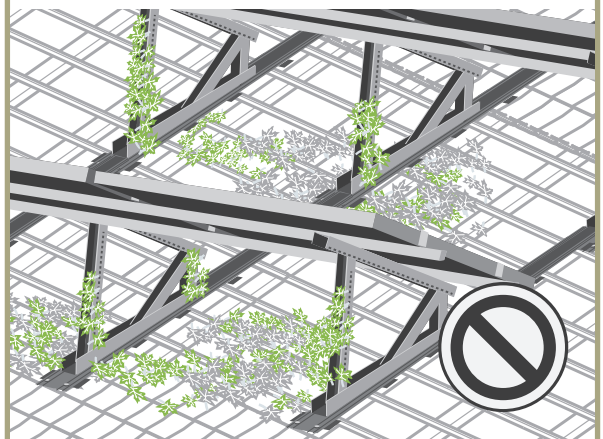

CONTACT

HANWHA Q CELLS GMBH

OT Thalheim
Sonnenallee 17–21
06766 Bitterfeld-Wolfen
Germany

TEL +49(0)3494 6699–23222
FAX +49(0)3494 6699–23000

EMAIL service@q-cells.com
WEB www.q-cells.com