

General Installation Manual

Photovoltaic Module HIT®

VBHNxxxSA series

VBHNxxxKA series

Model No.

·VBHNxxxSA17

xxx=340, 335, 330, 325

·VBHNxxxKA03

xxx=325, 320

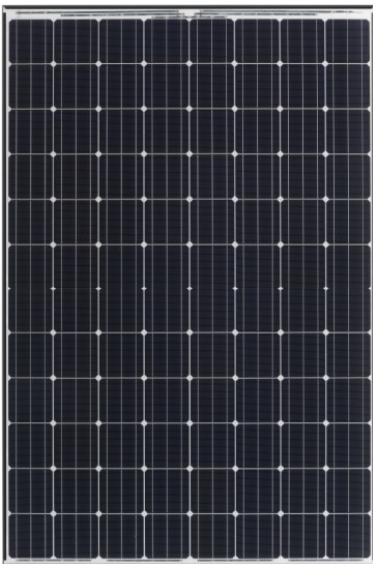

VBHNxxxSA17 series



VBHNxxxKA03 series

CONTENTS

SAFETY PRECAUTIONS	2
·GENERAL INFORMATION	
·WARNING	
·CAUTIONS	
MODULE SPECIFICATIONS	3
MECHANICAL LOADING	
STANDARDS	5
FIRE CLASS OF PRODUCT	
BYPASS DIODE	
INSTALLATION	6
·GENERAL	
·OPERATING CONDITIONS	
·SPECIAL CONDITIONS	
·UNPACKING AND HANDLING	
·MODULE PALLET STORAGE	
·MODULE INSTALLATION	
WIRING	8
·GENERAL	
·MODULE WIRING	
·ARRAY WIRING	
·EARTH GROUND WIRING	
·GROUNDING METHODS	
MAINTENANCE	13
·ANTI-REFLECTION GLASS SURFACE CLEANING	
DISCLAIMER OF LIABILITY	13
CONTACT INFORMATION	13

Thank you for choosing Panasonic photovoltaic module HIT®. Please read this manual completely before you install or use of HIT®. With proper operation and maintenance, HIT® will provide you with clean, renewable solar electricity for many years. This manual contains important installation, maintenance and safety information. The word "module" as used in this manual refers to one or more PV modules. Retain this manual for future reference.

"HIT" is a trademark of the Panasonic Group.

Other product and service names listed in this manual are trademarks or registered trademarks of respective companies.

SAFETY PRECAUTIONS

- All instructions should be read and understood before attempting to install, wire, operate, and maintain the module.
- The installation of modules requires a great degree of skill and should only be performed by qualified licensed professionals, including, without limitation, licensed contractors and licensed electricians.
- The installer assumes the risk of all injury that might occur during installation, including, without limitation, the risk of electric shock.
- Before installing modules, contact the appropriate authorities to determine permissions, installation and inspection requirements, which should be followed.
- Be sure that the construction or structure (roof, etc.) where the modules are being installed has enough strength.
- Both roof construction and module installation design have an effect on the fire resistance of a building. Improper installation may contribute to fire hazards. Additional devices such as ground fault, fuses, and disconnects may be required.
- For a non-integral module or panel, the assembly is to be mounted over a fire resistant roof covering rated for the application.
- For modules mounted on roofs, special construction or structures may be required to help provide proper installation support.
- **Do not install** the module where flammable gases or vapors are present.
- **Do not use** modules of different specifications in the same system.
- Follow all safety precautions of other system components used.
- In some areas, local electrical codes may govern the installation and use of modules.

WARNING

To avoid the hazard of **electric shock, sparks, fire and injury**

- The modules generate DC electrical energy when exposed to sunlight or other light sources, so cover the entire front surface of the modules with a dense, opaque material such as a cardboard box, during installation and handling of the modules.
- The shock hazard increases as modules are connected in parallel, producing higher current, and as modules are connected in series, producing higher voltages.
- The shock hazard increases as modules with nominal open-circuit voltage (Voc) in excess of 50 V, and/or modules rated for maximum system voltage in excess of 50 V.
- Wear suitable clothing, gloves and guards to prevent from direct contact with 30 VDC or greater.
- Work only in dry conditions, with dry modules and dry tools.
- Children and unauthorized persons should not be allowed near the installation of modules.
- **Do not puncture or damage** the backsheet of a module. Do not use the PV module and make a replacement, when scratch exposing conductive part is found on the backsheet.
- **Do not disassemble** the module, or remove any parts installed by the manufacturer.
- **Do not open** a junction box's lid.
- **Do not touch** the junction box terminals.
- **Do not change** the wiring of bypass diodes.
- **Do not connect or disconnect** terminals while modules generate electricity and connect electrical load.
- **Never leave** a module unsupported or unsecured.

CAUTIONS

To avoid the hazard of **injury, burn and damage to the module**

- Use a module for its intended purpose only.
- Be sure that all other system components are compatible, and they do not subject the module to mechanical or electrical hazards.
- **Do not artificially concentrate** sunlight on a module.
- **Do not stand or step** on a module.
- When carrying a module, **two or more people** should carry it by its frame and **wear non-slip gloves**.
- **Do not carry** a module by its wires or junction box.
- **Do not drop** a module.
- **Do not drop** anything on the surface of a module.
- **Do not hit** the back side of a module by the connector or other object. Back side is easily damaged.
- **Do not stack** anything on back side of module.
- **Do not disassemble** a module, attempt any repair, open the junction box cover, nor remove any parts installed by Panasonic. There are no user serviceable parts within the module or junction box.
- **Do not treat** the back sheet or front surface with paint or adhesives.
- **Do not use or install** broken modules. If you find a breakdown such as glass breakage, contact the professional installer to replace it promptly.
- **Do not touch** a module unnecessarily. The glass surface and frames get hot.

MODULE SPECIFICATIONS

- Module specifications are shown in Table 1 and Figure 1. (Electrical specifications, mechanical specifications, module dimensions)
- Rated electrical characteristics are within the range of -5% to +10% of the values measured at Standard Test Conditions (STC). STC conditions are; Irradiance of 1000W/m², 25°C cell temperature, AM1.5 and solar spectral irradiance per IEC 60904-3. Note: At the time of shipment, Panasonic guarantees the output level of its modules to be -0/+10% against Rated Power in SPECIFICATIONS based on factory inspection at STC conditions.
 - Under real conditions, a photovoltaic module may experience conditions that produce more current and/or voltage than reported at Standard Test Conditions. Therefore, the I_{sc} value of modules should be multiplied by a factor of 1.25 to determine ampacity. An

additional factor of 1.25 may be required for sizing conductors, fuses, disconnects, etc. Please refer to **section 690.8 of the National Electric Code (NEC)** for guidelines. The Voc must be factored according to the lowest recorded ambient temperature recorded for the location where the modules will be installed. Please refer to **section 690.7 of the NEC** for more information regarding voltage temperature factors.

MECHANICAL LOADING

- The modules should be mounted at the four (4) quarter points by the means shown in Figure 1.
- This method offers a maximum load shown as "Mount Location and Load Resistance" in Figure 1 in a static state on the module surface.
- Note: This mechanical loading value was tested using the mounting device specified in section "MODULE INSTALLATION"

- As UL Certified Load Ratings, this module meets design loads as below.
- Positive load with Long frame mounting
 - 33 psf (0-450mm range from edge)
 - 75 psf (230-380mm range from edge)
 - Negative load with Long frame mounting
 - 33 psf (0-450mm range from edge)
 - 61 psf(230-380mm range from edge)
 - 75 psf (230-345mm range from edge)
 - Positive load with Short frame mounting
 - 33 psf (0-250mm range from edge)
 - Negative load with Short frame mounting
 - 33 psf (0-250mm range from edge)

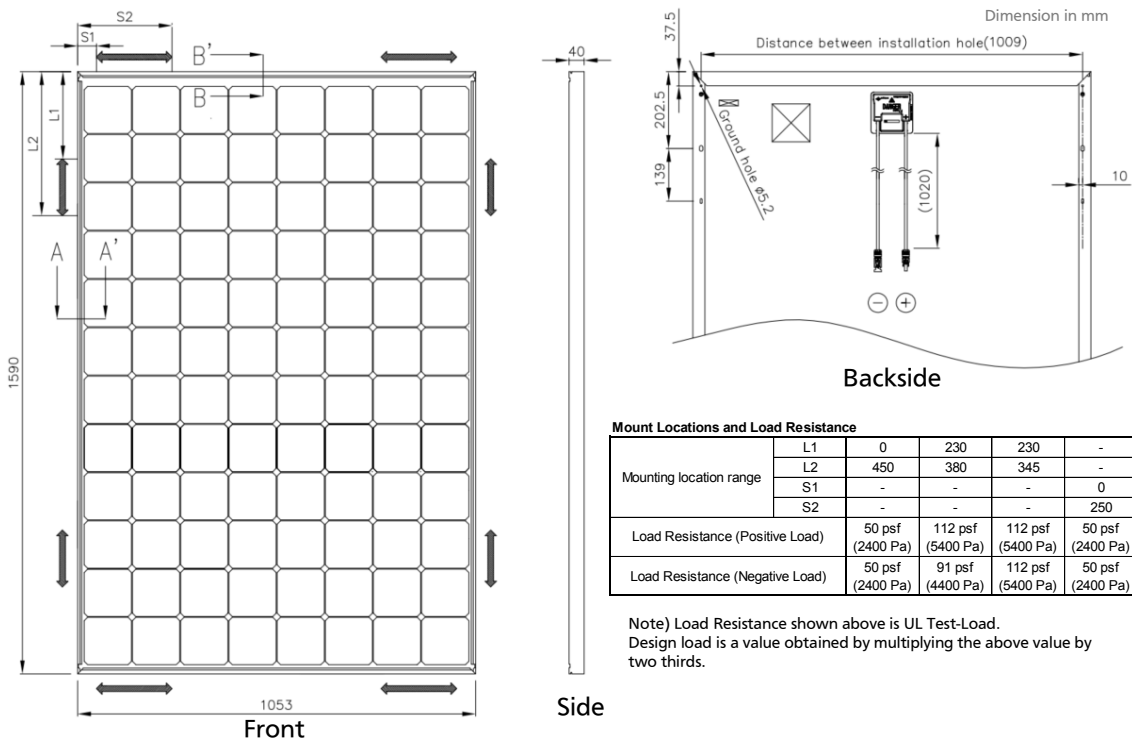

Note) A module is installed using 4 points, symmetrical mounting within setting range (shaded). Setting range parameters are shown in "Mount Locations and Load Resistance" table.

Figure 1. Module Dimension

Table 1. Model Specifications

Electrical Specifications

Model	VBHN340SA17	VBHN335SA17	VBHN330SA17	VBHN325SA17	VBHN325KA03	VBHN320KA03
Cell Number in Series	96	96	96	96	96	96
Rated Power, Watts (Pmax)	340	335	330	325	325	320
Maximum Power Voltage (Vpm)	59.7	59.4	58.0	57.6	59.2	58.7
Maximum Power Current (Ipm)	5.70	5.65	5.70	5.65	5.50	5.46
Open Circuit Voltage (Voc)	71.3	71.0	69.7	69.6	70.9	70.5
Short Circuit Current (Isc)	6.13	6.08	6.07	6.03	5.94	5.89
Cell Type	Silicon hetero-junction*	Silicon hetero-junction*	Silicon hetero-junction*	Silicon hetero-junction*	Silicon hetero-junction*	Silicon hetero-junction*
Maximum System Voltage	600	600	600	600	600	600
Factory Installed Bypass Diodes	4	4	4	4	4	4
Maximum series fuse (A)	15	15	15	15	15	15

Silicon hetero-junction*: Monocrystalline silicon/amorphous silicon hetero-junction

Mechanical Specifications

Length, mm (inches)	1590 (62.60)
Width, mm (inches)	1053 (41.46)
Frame Depth, mm (inches)	40 (1.57)
Weight, kg (pounds)	19 (41.89)

STANDARDS

VBHNxxxSA and VBHNxxxKA series comply with the requirements of UL1703.

FIRE CLASS OF PRODUCT

- The fire rating of this module is valid only when mounted in the manner specified in the mechanical mounting instructions.
- The models in this instructions are suitable to maintain the System Fire Class Rating A when used with a Listed mounting system and a roof covering that have been rated as a Class A System when installed on a steep slope roof and/or a low slope roof with "Type 2" modules.

JUNCTION BOX AND TERMINALS

- Modules equipped with one junction box contain terminals for both positive and negative polarity, and bypass diodes.
- Each terminal is dedicated to one polarity (with the polarity symbols engraved onto the body of the junction box) (see Figure 2).
- Each terminal is provided with factory installed lead cables and a latch-

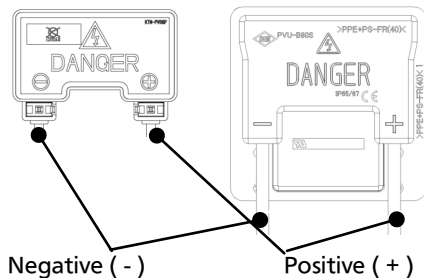

Figure 2. Junction Box

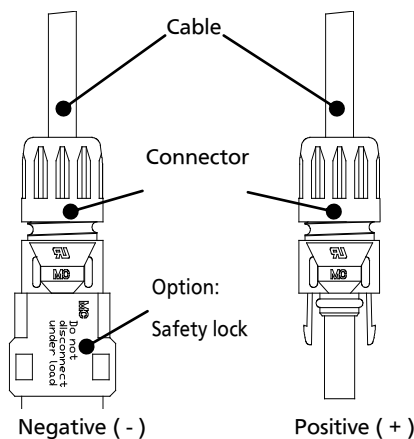

Figure 2. Connectors

ing connector for series and string connections. Always use these connectors and do not detach them from cables.

- The PV module comes pre-wired. Each module has two **#12 AWG type PV-wire** stranded sunlight resistant output cables each terminated with connectors. The positive (+) terminal has a male connector while the negative (-) terminal has a female connector. The module wiring is solely for series connections only, i.e. male (+) to female (-) interconnections. When making field wiring connections to the preattached connectors use only approved connectors from Table.2.
- Latching connectors are **type IV** and made by **STAUBLI ELECTRICAL CONNECTORS AG**. Supplied connectors listed by UL.
- In order to comply with NEC 2008, a locking sleeve needs to be used with all connectors that are exposed.
- The locking sleeve (PV-SSH4) is made by STAUBLI and can only be released with a special tool also made by STAUBLI (PV-MS). Locking sleeves are not supplied with mod-
- ules and must be purchased separately.

BYPASS DIODE

- When the modules in series strings are shaded partially, it may cause reverse voltage across cells or modules, because the current from other cells in the same series is forced to flow through the shaded area. This may cause undesirable heating to occur.
- The use of a diode to bypass the shaded area can minimize both heating and array current reduction.
- All modules are equipped with factory installed bypass diodes. The factory installed diodes provide proper circuit protection for the systems within the specified system voltage, so that you do not need any other additional bypass diodes.
- Specifications of bypass diode for VBHNxxxSA and VBHNxxxKA modules are as follows; Type: Number of bypass diode: 4 diodes, Number of series cells per bypass diode: 24 cells / diode (See Figure 3).

	24 cells /	
	24 cells /	
	24 cells /	
	24 cells /	

Figure 3. Number of series cells per bypass diode

Table.2 Approved connectors list

Manufacturer	STAUBLI ELECTRICAL CONNECTORS AG
Contact Information	http://ec.staubli.com
Model #	
PV-KST4, PV-KBT4 followed by /2.5 or /6, followed by "I" or "II", followed by -UR. or - may be followed by additional suffixes, may be followed by suffix numbers and letters.	
PV-PLS-S, PV-PLS-B, may be followed by suffix numbers and letters, may be followed by suffix numbers and letters.	
Male PV connectors, PV-KST4-EVO2/2.5, 6 or 10, followed by I, II, III or IV, followed by -UR.	
Female PV connectors, PV-KBT4-EVO2/2.5, 6 or 10, followed by I, II, III or IV, followed by -UR	

INSTALLATION

GENERAL

Please read this guide completely before installation or use of the modules.

OPERATING CONDITIONS

Panasonic recommends that modules be operated within the following Operating Conditions. An installation location with conditions beyond the Operating Conditions or with other Special Conditions (see below) should be avoided. Operating Conditions of Panasonic modules are as follows:

- 1) The modules should be operated only in terrestrial applications. No space or other Special Conditions.
- 2) The operating temperature must be within **-40°C (-40°F) to 85°C (185°F)**.
- 3) The wind pressure load of the installation site should be less than Load Resistance shown in "Mount Locations and Load Resistance" table in Figure 1.

UNPACKING AND HANDLING

- **Do not hit** the back sheet of a module by the connector when unpacking and handling.
- Please do not expose the connector the rain water and dust .
- To avoid the damage of the back sheet by the connector, fix the cables to the frame with tape after unpacking. (refer Figure 4)
- **Do not handle** modules by their cables or junction box. Handle them by the frame with both hands in any situation.
- The anti-reflection glass of a module is easy to be soiled, when it is grasped by hand or hand gloves. So it is recommended to hold cardboard or frames when carrying or installing the solar module. When cables and connectors touch the surface of the glass, it may soil the surface too. It is also recommended to avoid contact of cables and connectors with surface of the glass. (If the glass surface becomes dirty, see section of "anti-reflection glass surface cleaning".)

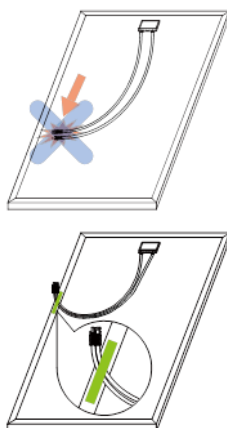

Figure 4. Fixing of cables and connectors

MODULE INSTALLATION

- Install modules where they are not shaded by obstacles like buildings or trees. Especially pay attention to avoid partially shading the modules by objects during the daytime. If a part of the PV module is always shaded, hot spot may occur and the PV module may break down.
- Water stains might be caused when rain water remains on the glass surface for a long time. To avoid water stains, Panasonic recommends to install modules at a slope steeper than the water gradient.
- Modules should be firmly fixed in place in a manner suitable to withstand all expected loads, including wind and snow loads.
- Metals used in locations that are exposed to moisture shall not be employed alone or in combinations that could result in deterioration or corrosion.
- The clamps should be made of aluminum alloy or other material that will reasonably protect against a risk of electrolytic corrosion.
- Clearance between the roof surface and module frame is required to allow cooling air to circulate around the back of the module. This also

allows any condensation or moisture to dissipate. The required clearance between the roof surface and the module is **more than 4 inch**.

- The modules should be mounted basically at the four (4) quarter points by the means shown in Figure 1, and based on installation methods shown in Figure 5.
- Figure 5 shows using a bolt and nut for mounting.
- **Do not contact** a tip of a mounting bolt to back sheet of the module when fixing the module to the mounting structure rail.
- Recommendation of bolt torque: 10 ft-lbs.
- Figure 5 shows that a module should be attached on a mount or support structure rail by corrosive-resistant metal clamps.
- Appropriate material should be used for mounting hardware (the module frame, mounting structure, and hardware) to prevent itself from corrosion.
- Panasonic does not provide a warranty for clamps. The module warranty Panasonic provides shall be voided if clamps selected by the customer are of an improper material or size.

- Please contact your Panasonic Authorized Representative with questions regarding mounting profiles for modules if needed.

- The module was tested using IronRidge clamps with the specifications see Figure 5 and below;

IronRidge clamps:

- Provider: IronRidge Inc.
- Product Line: RoofMount
- Clamps type: Top Mounting Clamps (Universal Fastening Objects(UFOs) and Stopper Sleeves)
- IronRidge Part No. UFO-CL-001, UFO-CL-001B, UFO-STP-40MM, UFO-STP-40MM-B
- Width: Universal Fastening Objects; 1.12"(28.4 mm), Stopper Sleeves; 1.09"(27.7 mm)
- Thickness: Universal Fastening Objects 0.29"(7.4mm),
- Torque: 9.04 N.m (80 in-lbs).
- Material: Universal Fastening Objects; 300 Stainless steel, Stopper Sleeves; 6000 Aluminum alloys
- Note: Please refer to IronRidge manual, for installation method.

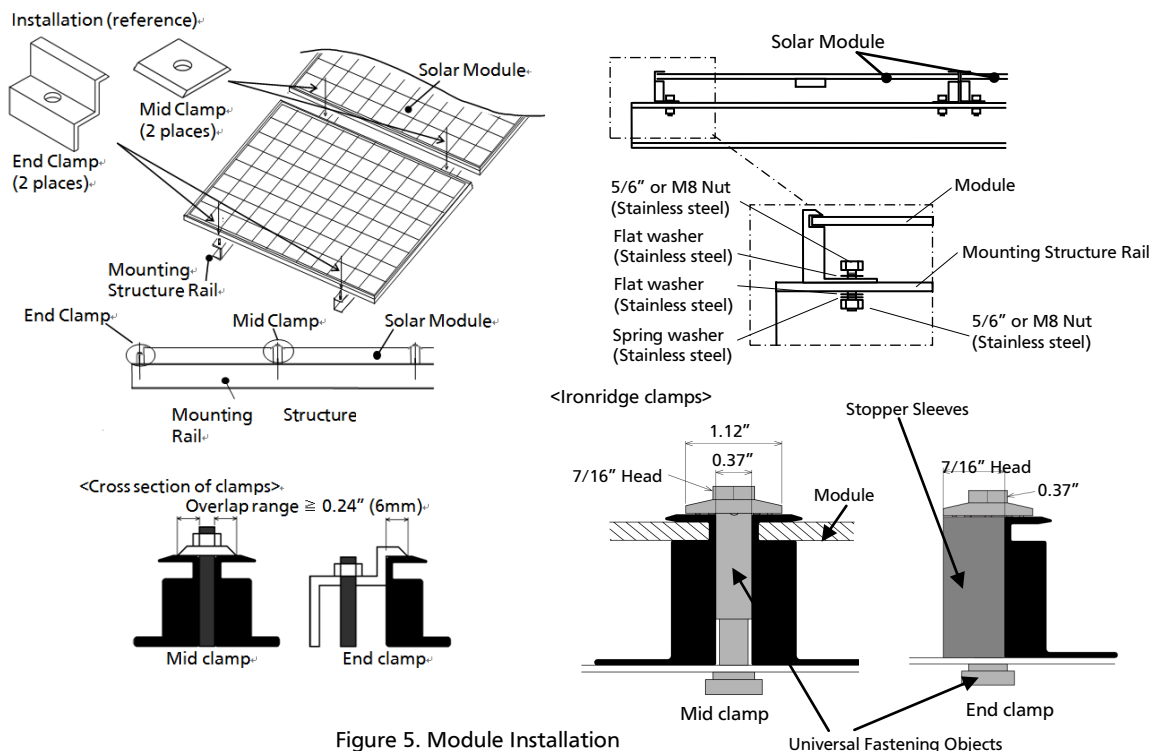

Figure 5. Module Installation

WIRING

GENERAL

- All wiring should be done in accordance with applicable electrical codes.
- Wiring methods should be in accordance with the NEC in USA or CEC in Canada.
- All wiring should be done by a qualified, licensed professional.
- Wiring should be protected to help ensure personal safety and to prevent its damage.
- Please connect each cable after confirming the polarity of it is correct.
- Connectors between modules must be inserted until they click.
- When connecting the connectors, please make sure that foreign matter such as water, sand and so on do not get inside the connector. Also, please keep in mind that if you leave the connector in a non-connected state for a long period of time, contamination of foreign matter is likely to occur.
- If an extreme load is applied to the cable, the cables may come off the junction box body or the connectors. Please connect so that a strong load is not applied to the cable.
- When fixing the cable to the module structure rail, make sure the curvature of the cable is R50 mm or more.
- **Do not disconnect** terminals while modules generate electricity and connect electrical load to avoid the hazard of electrical shock.
- Cable conduits should be used in locations where the wiring is inaccessible to children or small animals.
- These modules contain factory installed bypass diodes. If these modules are connected each other incorrectly, the bypass diodes, cables, or junction box may be damaged.
- Please contact your Panasonic Authorized Representative with questions regarding other electrical con-

nections if needed.

MODULE WIRING

- All modules connected in series should be of the same model number and/or type.
- The number of modules that can be wired in series is recommended to be **seven (7) or fewer**. If connecting eight (8) modules in series, check local temperature conditions and follow the National Electric Code (690.7) to ensure compliance with maximum voltage limitations.
- If modules will be used in an "off-grid" system, a compatible MPPT (Maximum Power Point Tracking) charge controller is required. Note: Panasonic HIT 96-cell modules have a higher Voc than conventional 60-cell modules, thus extra consideration must be taken to ensure charge controller compatibility. Especially charge battery can not be used without MPPT.
- These modules contain factory installed bypass diodes. If these modules are incorrectly connected to each other, the bypass diodes, cable, or junction box may be damaged.
- Do not connect modules in parallel without using connection devices that connect to appropriate FUSE for each series string or each module.

ARRAY WIRING

- The term "array" is used to describe the assembly of several modules on a support structure with associated wiring.
- When installing a PV array, the system design must be completed with reference to the module electrical specifications for proper selection of inverters, fuses, breakers, charging controllers, batteries and other storage devices. In particular, as the temperature characteristic of the PV module, the voltage value rises on the low temperature side. Consider the lowest temperature in the area where the system is installed and select the equipment so that it does not exceed the rated voltage of the equipment.

- Use copper wire which is insulated to withstand the maximum possible system open circuit voltage. For applications where wire conduits are used, follow the applicable codes for outdoor installation of wires in conduits. Minimum diameter of wire conduit is 4 mm². The temperature rating of conductor is –40 ~ 90 °C.
- In order to avoid submerging cables and connectors in the water, cables must be fixed either to the module frame using cable fixing holes or to the mounting structure. Also, if the cable is not secured, a force may be applied to the cable from the outside, and the module may be damaged.
- **Do not insert** PV cable between back side and mounting structure rail. When snow weight is applied to the module, load may be applied to the cable.
- Verify that all fittings are properly installed to protect cables against damage and prevent moisture intrusion.
- Check your local codes for requirements.

EARTH GROUND WIRING

- A module with exposed conductive parts is considered to be in compliance with UL 1703 only when it is electrically grounded in accordance with the instructions presented below and the requirements of the National Electrical Code.
- The array frame shall be grounded in accordance with NEC Article 250 (USA) or the CEC in Canada.
- All modules should be grounded. All structures or metallic components in direct contact with the modules or electric wires should be properly grounded too.
- Each ledge on the module frame has two larger holes for bolts (0.205" diameter (5.2 mm)). These ground holes are marked with "earth indication mark" adjacent to their location on the frame rail (see Figure 6.1).
- Ground wires must be connected to the module's metal frame at one of these locations.
- **Length of bolt should not be more than 0.78" (20 mm)** in order to avoid contacting the back-sheet of the module.
- Lay-in lugs or grounding clips can be used to ground Panasonic PV modules. Both methods are explained below, please choose one.
- Great care should be exercised to ensure that corrosion caused by the grounding means be avoided.
- Corrosion can increase the resistance of the grounding connection on the module, or can even cause the grounding connection to fail entirely. Corrosion can be caused by the effects of weather, humidity, dirt and so on. It can also be caused when two dissimilar metals are in contact (galvanic reaction).
- The module frame material is aluminum/magnesium alloy.
- All fasteners (nuts, bolts, washers, screws, etc.) must be stainless steel unless otherwise specified.
- We recommend installing a lightning rod and SPD (Surge protection device) to reduce damage or breakdown to the PV module caused by lightning.

ware (nuts, bolts, star washers, splitting lock washers, flat washers and the like) is used to attach a listed grounding/bonding device, the attachment must be made in conformance with the grounding device manufacturer's instructions.

- Common hardware items such as nuts, bolts, star washers, lock washers and the like have not been evaluated for electrical conductivity or for use as grounding devices and should be used only for maintaining mechanical connections and holding electrical grounding devices in the proper position for electrical conductivity. Such devices, where supplied with the module and evaluated through the requirements in UL 1703, may be used for grounding connections in accordance with the instructions provided with the module.

GROUNDING METHODS

- Where common grounding hard-

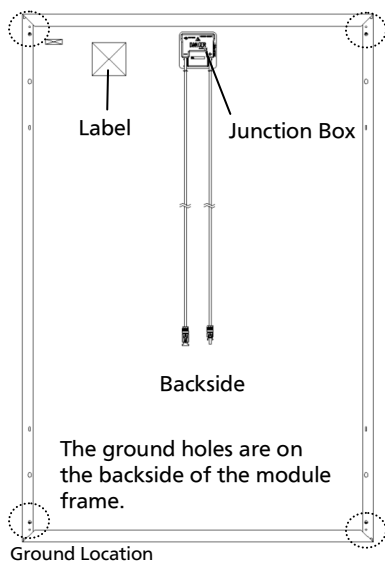

Figure 6.1
Module Ground Position

Using bolt and nut

(see Figures 6.2)

- If using this method, use one of the larger holes with diameter of 0.205" (5.2 mm)
- The bolt and nut size should be No.8 (0.164" diameter (4.16 mm)), or No.10 (0.190" diameter (4.83 mm)) or M5 (0.197" diameter (5.0 mm)).
- Star washers must be used to make contact through the anodization of the module for this method.
- In this case, the screw threads are not providing the electrical ground contact.
- Recommended torque value in tightening bolt and nut is 2.3 N.m (20in-lb).

Using cup washers

(see Figures 6.2)

- The use of cup washers is to prevent wire from slipping out from under the screw head (and/or the flat washer).
- Make sure that the cup washer is placed between the wire and the module frame.
- Choose an adequate size for the cup washer and the flat washer so that the wire is fully clamped between them.
- Note: Cup washers are also called terminal cup washers.
- The cup washers should be stainless steel, or a cup washer made of brass may be used only if a large flat washer made of stainless steel is inserted between the module frame and the cup washer.
- Choose the adequate size for the large flat washer (between the module frame

and the cup washer) so that the cup washer doesn't contact the module frame and is fixed stably to the module frame.

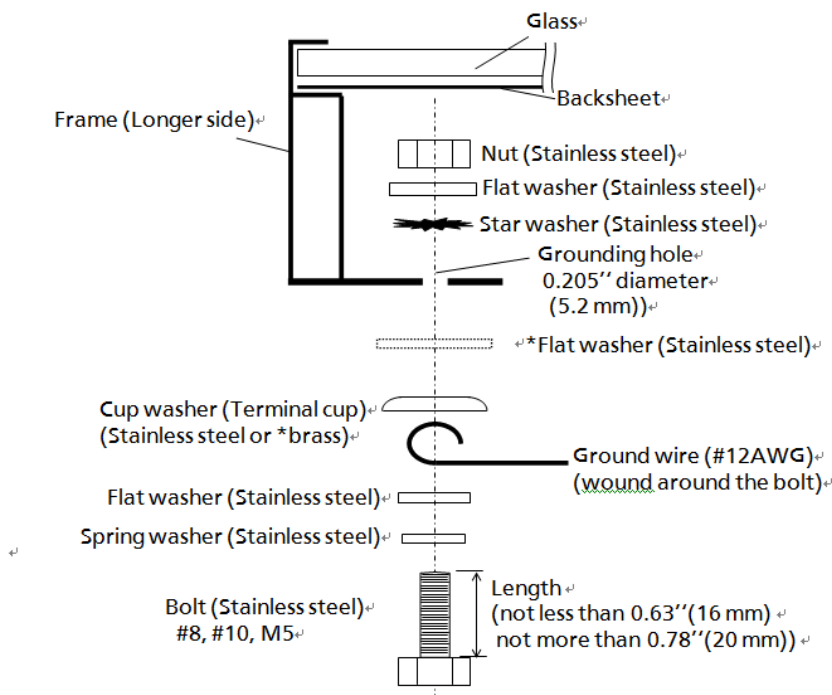

Note: Use the ground holes illustrated in Figure 6.1.

*If using a brass cup washer, a flat washer must be inserted between the cup washer and module frame, and the flat washer diameter must be greater than the cup washer

Figure 6.2
Using bolt and nut

Using a lay-in lug with bolt and nut (see Figure 6.3)

- If using this method, please follow instructions in previous section regarding using bolts and nuts with larger grounding holes.
 - Use a grounding tin plated solid copper lay-in lug rated for direct burial and outdoor use. Lug must be used ILSCO GBL-4DBT, BurndyCL501TN.
 - Attach grounding lug to module frame using a stainless steel bolt and lock-nut.
 - Tighten stainless steel set screw at the torque specified by lug manufacturer to secure copper wire.
 - The specified torque is following
 - ◇ IlSCO Corp. GBL-4DBT
 - 10-14AWG-Solid -> 20 in-lbs,
 - 4-6AWG-Strand -> 35 in-lbs,
 - 8AWG-Strand -> 25 in-lbs, 10-14AWG-Strand -> 20 in-lbs
 - ◇ Burndy L L C CL501TN 14AWG-Solid -> 35 in-lbs, 14AWG-Strand -> 35 in-lbs, 4AWG-Strand -> 45 in-lbs
- Recommended torque value in tightening bolt and nut is 2.3 N.m (20in-lb).

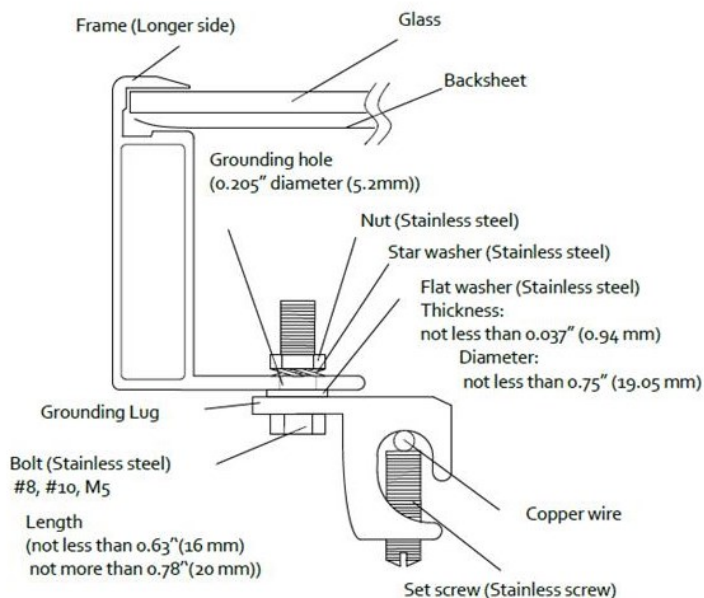

Figure 6.3

Using a lay-in lug with bolt and nut

Note: Use the ground holes illustrated in Figure 6.1.

Select a grounding the following lug.

ILSCO GBL-4DBT,
Burndy CL501TN

Using a Grounding Clip with bolt and nut (see Figure 6.4)

For more information, please refer to Instruction sheet issued by Tyco Electronics.

- Use Tyco Electronics 1954381-2 as grounding clip.
- Place the grounding clip onto the module frame.
- Thread the hex nut onto the end of the screw, then using a 3/8-in. wrench, tighten the nut. Recommended torque value in tightening bolt and nut is between 1.7 and 2.2 Nm.
- Insert the wire into the wire slot. Press down on both ends of the wire.
- Manually, or using channel lock pliers, push the slider over the base until it covers the base. This will terminate the wire.

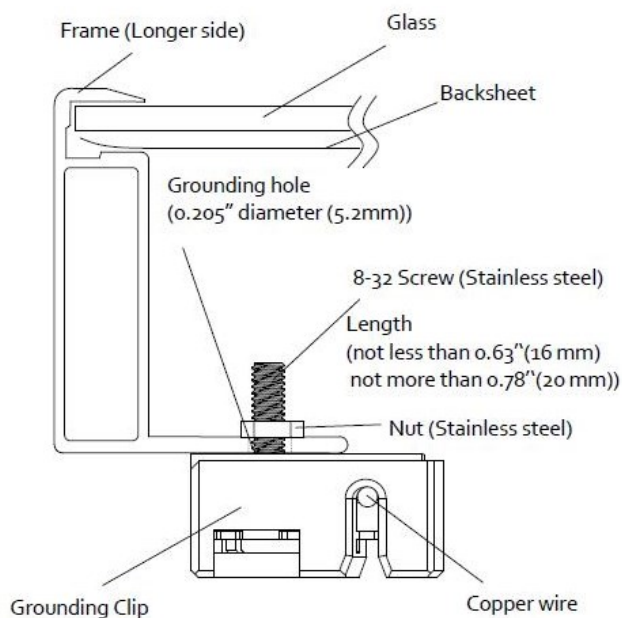

Note: Use the ground holes illustrated in Figure 6.1.

Grounding Clip Assemblies:
Tyco Electronics 1954381-2

Figure 6.4

Using a Grounding Clip with bolt and nut

MAINTENANCE

- In order to maintain the optimum output of the module, quality and safety, please conduct periodic inspection or cleaning.
- It is also recommended to inspect the electrical and mechanical connections annually.
- If you need electrical or mechanical inspection or maintenance, it is recommended to have a licensed authorized professional carry out the inspection or maintenance to avoid the hazards of electric shock or injury.

ANTI-REFLECTION GLASS SURFACE CLEANING

- Light dirt that does not shield light completely does not significantly degrade power generation performance, but if the module surface becomes dirty, it may reduce output power, malfunction or hotspot may occur.
- It is recommended to clean the surface of the module with water and a soft cloth or sponge.
- When cleaning with neutral glass detergent or weak alkaline glass detergent, it is recommended to start with smallest area and from the edge of solar modules in order to check no damage occurs to the glass.
- After that, clean surface of glass with wet and clean cloth.
- Recommended detergent: "Glass Magiclean"¹⁾ or "Windex® Original"²⁾
 - 1) Glass Magiclean is a trademark of Kao Corporation.
 - 2) Windex® is a trademark of SC Johnson & Son, Inc.
- It is recommended to read carefully the manuals of detergent and understand notes on usage and first-aid treatment.
- To remove persistent dirt, the module can be washed with a micro-fiber cloth and ethanol.
- **Never use** abrasive detergent, strong alkaline detergent, strong

acid detergent or a detergent which forms a protective layer on the surface of the glass to clean any part of the module. The performance of a solar modules may be reduced. Please be very careful since the warranty will not cover the damages caused by detergents.

- When cleaning the PV module, please do not put detergent on junction box or connector. If detergents and chemical substances adhere, junction box and connector may be deteriorated or damaged.

DISCLAIMER OF LIABILITY

Panasonic does not assume responsibility and expressly disclaims liability for loss, damage, or expense arising out of, or in any way connected with installation, operation, use, or maintenance by using this manual.

Panasonic assumes no responsibility for any infringement of patents or other rights of third parties, which may result from use of modules.

No license is granted by implication or under any patent or patent rights. The information in this manual is believed to be reliable, but does not constitute an expressed and/or implied warranty.

As part of our policy of continuous improvement Panasonic reserves the right to make changes to the product, specifications, or manual at any time without prior notice.

The return of any modules will not be accepted by Panasonic unless prior written authorization has been given by Panasonic.

CONTACT INFORMATION

Panasonic Life Solutions Company of America, Two Riverfront Plaza, 5th Floor, Newark, NJ 07102

panasonicHIT@us.panasonic.com

na.panasonic.com/us/solar

© SANYO Electric Co., Ltd. 2019

SANYO is part of the Panasonic Group and is in charge of the manufacturing process for HIT®

IMA001-0919-2.3

REVISION HISTORY

Edition	Revision Date	Revised Item	Revised Content
NEW	2017.11.16		
Ver.1	2018.5.14	Change of format	Representation of layout, description sentences
Ver.1.1	2018.9.28	Review of wording	Review wording on warranty and notes, delete special conditions
Ver.1.2	2018.10.17 2018.10.31	Correction of Ver.1.1, reexamination of expression	Minimum regional temperature consideration, representation on off-grid and battery charge. Addition of module pallet storage
Ver.2.1	2018.12.5	Addition of models	<ul style="list-style-type: none"> ·Add models of VBHN340SA17 and VBHN335SA17 ·Add electrical specifications of VBHN340SA17 and VBHN335SA17
Ver.2.2	2019.4.1	The company name change	Panasonic Eco Solutions of North America →Panasonic Life Solutions Company
Ver.2.3	2019.9.30	Change of Cautions text	Representation of description sentences