

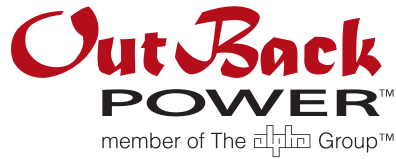

GS Load Center

Installation Manual



About OutBack Power Technologies

OutBack Power Technologies is a leader in advanced energy conversion technology. OutBack products include true sine wave inverter/chargers, maximum power point tracking charge controllers, and system communication components, as well as circuit breakers, batteries, accessories, and assembled systems.

Grid/Hybrid™

As a leader in off-grid energy systems designed around energy storage, OutBack Power is an innovator in Grid/Hybrid system technology, providing the best of both worlds: grid-tied system savings during normal or daylight operation, and off-grid independence during peak energy times or in the event of a power outage or an emergency. Grid/Hybrid systems have the intelligence, agility and interoperability to operate in multiple energy modes quickly, efficiently, and seamlessly, in order to deliver clean, continuous and reliable power to residential and commercial users while maintaining grid stability.

Contact Information

Address:	Corporate Headquarters 17825 – 59 th Avenue N.E. Suite B Arlington, WA 98223 USA	European Office Hansastraße 8 D-91126 Schwabach, Germany
Website:	http://www.outbackpower.com	

Disclaimer

UNLESS SPECIFICALLY AGREED TO IN WRITING, OUTBACK POWER TECHNOLOGIES:

(a) MAKES NO WARRANTY AS TO THE ACCURACY, SUFFICIENCY OR SUITABILITY OF ANY TECHNICAL OR OTHER INFORMATION PROVIDED IN ITS MANUALS OR OTHER DOCUMENTATION.

(b) ASSUMES NO RESPONSIBILITY OR LIABILITY FOR LOSS OR DAMAGE, WHETHER DIRECT, INDIRECT, CONSEQUENTIAL OR INCIDENTAL, WHICH MIGHT ARISE OUT OF THE USE OF SUCH INFORMATION. THE USE OF ANY SUCH INFORMATION WILL BE ENTIRELY AT THE USER'S RISK.

OutBack Power Technologies cannot be responsible for system failure, damages, or injury resulting from improper installation of their products.

Information included in this manual is subject to change without notice.

Notice of Copyright

GS Load Center Installation Manual © 2012 by OutBack Power Technologies. All Rights Reserved.

Trademarks

OutBack Power, the OutBack Power logo, and Grid/Hybrid are trademarks owned and used by OutBack Power Technologies, Inc. The ALPHA logo and the phrase "member of the Alpha Group" are trademarks owned and used by Alpha Technologies Inc. These trademarks may be registered in the United States and other countries.

Date and Revision

October 2018, Revision A

Part Number

900-0123-01-01 Rev A



Table of Contents

Audience	6
Symbols Used	6
General Safety	6
Introduction	7
Welcome to OutBack Power Technologies.....	7
GSLC – Components.....	10
GSLC175-120/240 – Components.....	11
GSLC175-230 – Components.....	12
GSLC175-PV-120/240 – Components.....	13
GSLC175-PV-230 – Components.....	14
GSLC175PV1-120/240 – Components.....	15
GSLC175PV1-230 – Components.....	16
Planning	17
Tools Required.....	17
Materials Required.....	17
Location/Environmental Requirements	17
Installation	19
Hardware Options	19
Remove Top Cover.....	20
Remove Front Door	21
Remove Interior Cover.....	21
Installing the Internal Hardware	22
Assembling DC Positive (+) Cable Plate (Bus Bar)	23
Installing Inverter Positive Bus Bars.....	24
Installing Inverter Main DC Disconnects	25
Installing DC Shunts.....	26
Installing Circuit Breakers and GFDI.....	27
Mounting on the Inverter.....	28
Mounting FLEXmax Charge Controller	30
Mounting the HUB Communications Manager.....	31
Wiring.....	33
Grounding.....	33
Bonding.....	34
DC Wiring	35
Inverter Wiring	35
Battery Wiring	35
Installing the FLEXnet DC.....	37
DC Devices.....	38
PV and Charge Controller Wiring.....	38
AC Wiring	41
Split-Phase Wiring	41
Single-Phase Wiring	43
Wiring the AC Bypass Assembly	45
Multiple-Inverter Installations (Stacking Inverters)	46
Bypass Switches.....	47
Wiring Diagrams	49

Table of Contents

Specifications	59
Electrical and Mechanical Specifications	59
Regulatory Specifications	59
Definitions	60
Index	61

List of Tables

Table 1	Requirements for Circuit Breakers and Bus Bars	22
Table 2	Terminal Bus Bar (TBB) Wire Size and Torque Requirements	33
Table 3	Specifications	59
Table 4	Terms and Definitions	60

List of Figures





Figure 1	GS Load Center (GSLC)	7
Figure 2	GS Load Center with Devices	9
Figure 3	GSLC Components	10
Figure 4	GSLC175-120/240 Components	11
Figure 5	GSLC175-230 Components	12
Figure 6	GSLC175-PV-120/240 Components	13
Figure 7	GSLC175-PV-230 Components	14
Figure 8	GSLC175PV1-120/240 Components	15
Figure 9	GSLC175PV1-230 Components	16
Figure 10	Dimensions	17
Figure 11	Knockouts and Mounting Holes for Devices	18
Figure 12	GSLC – Additional Components	19
Figure 13	GSLC175-120/240 and GSLC175-230 – Additional Components	20
Figure 14	Removing the Top Cover from the GSLC	20
Figure 15	Removing the Front Door from the GSLC	21
Figure 16	Removing the Interior Cover from the GSLC	21
Figure 17	DC Positive Cable Plate (FW-BBUS)	22
Figure 18	Assembling the DC Positive (+) Cable Plate	23
Figure 19	Inverter Bus Bars	24
Figure 20	Inverter Main DC Disconnects	25
Figure 21	DC Shunts	26
Figure 22	Circuit Breakers	27
Figure 23	Mounting the GSLC	28
Figure 23b	Mounting the GSLC (continued)	29
Figure 24	Mounting the Charge Controller to the GSLC Enclosure	30
Figure 25	Mounting the HUB Product to the GSLC Enclosure	31
Figure 26	Grounding	33
Figure 27	Removing Bonding Connections	34
Figure 28	Battery Connections	36
Figure 29	FN-DC and Wiring Block	37
Figure 30	Installing the FLEXnet DC	37

Figure 31	PV Connections in the GSLC.....	39
Figure 32	PV Connections in the FLEXmax Charge Controller	39
Figure 33	AC Terminal Bus Bars (split-phase).....	41
Figure 34	Inverter AC Connections (split-phase)	42
Figure 35	AC Terminal Bus Bars (single-phase).....	43
Figure 36	Inverter AC Connections (single-phase)	44
Figure 37	Maintenance Bypass Wiring (split-phase).....	45
Figure 38	Maintenance Bypass Wiring (single-phase).....	46
Figure 39	Bypass Switches.....	47
Figure 40	OutBack Bypass (split-phase).....	47
Figure 41	Bypass Switching for Multiple Inverters (split-phase).....	48
Figure 42	Wiring Diagram – GSLC175-120/240	49
Figure 43	Wiring Diagram – GSLC175-PV-120/240 with FN-DC	50
Figure 44	Wiring Diagram – GSLC-PV-300VDC with FN-DC	51
Figure 45	Wiring Diagram – GSLC175PV1-120/240 with FN-DC	52
Figure 46	Wiring Diagram – GSLC-PV1-300VDC with FN-DC	53
Figure 47	Wiring Diagram – GSLC175-230	54
Figure 48	Wiring Diagram – GSLC175-PV-230 with FN-DC	55
Figure 49	Wiring Diagram – GSLC-PV-300VDC-230 with FN-DC	56
Figure 50	Wiring Diagram – GSLC175PV1-230 with FNDC	57
Figure 51	Wiring Diagram – GSLCPV1-300VDC-230 with FN-DC	58

Audience

This book provides instructions for the functional settings and operation of this product. These instructions are for use by qualified personnel who meet all local and governmental code requirements for licensing and training for the installation of electrical power systems with AC and DC voltage up to 600 volts. This product is only serviceable by qualified personnel. Do not use this product without reading the appropriate Radian inverter/charger literature.

Symbols Used



	WARNING: Hazard to Human Life This type of notation indicates that the hazard could be harmful to human life.
	CAUTION: Hazard to Equipment This type of notation indicates that the hazard may cause damage to the equipment.
	IMPORTANT: This type of notation indicates that the information provided is important to the installation, operation and/or maintenance of the equipment. Failure to follow the recommendations in such a notation could result in voiding the equipment warranty.
	NOTE: This type of notation indicates useful information. This symbol is not always used.



MORE INFORMATION

When this symbol appears next to text, it means that more information is available in other manuals relating to the subject. The most common reference is to the Radian inverter *Installation Manual*. Another common reference is the Radian *Quick Start Guide*.

General Safety

	WARNING: Limitations on Use This equipment is NOT intended for use with life support equipment or other medical equipment or devices.
	WARNING: Reduced Protection If this product is used in a manner not specified by GS product literature, the product's internal safety protection may be impaired.
	CAUTION: Equipment Damage Only use components or accessories recommended or sold by OutBack Power Technologies or its authorized agents.



Introduction

Welcome to OutBack Power Technologies

Thank you for purchasing a GS Load Center (GSLC) from OutBack Power Technologies. The GSLC is part of an OutBack Grid/Hybrid™ system. It is a balance-of-systems enclosure intended to work with Radian Series (GS) Inverter/Chargers, FLEXmax Charge Controllers, and an OutBack HUB Communications Manager.

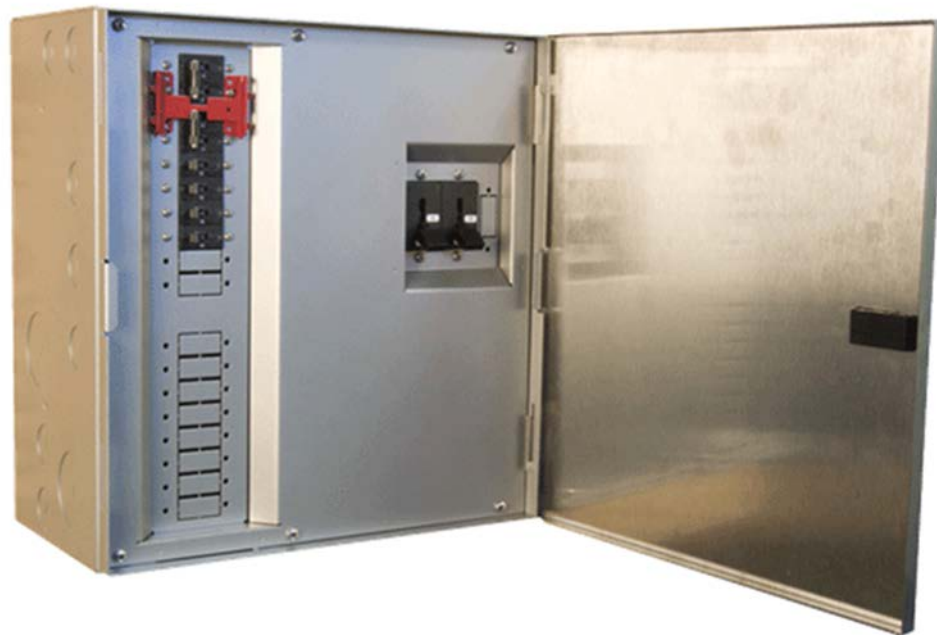

The removable front cover allows for opening from either side of the enclosure.

Figure 1 GS Load Center (GSLC)

The product is available in the following configurations:

- GSLC – GS Load Center for Radian Series. Recommended for custom-built systems. Recommended for use with multiple Radian inverters (one GSLC per inverter). Can be used with other inverter models. The term “GSLC” is also used to refer generically to the product line.
 - Intended for any Radian model.
- GSLC175-120/240 – GS Load Center for AC applications (split-phase). Factory-prepared with dual 175 Adc inverter circuit breakers, dual AC inputs, and 120/240 Vac maintenance bypass assembly. Recommended for systems which have a single Radian inverter and an AC source, but can be customized in other ways.
 - Intended for Radian models GS8048 and GS8048A.

Introduction

- **GS LC175-230** – GS Load Center for AC applications (single-phase). Factory-prepared with dual 175 Adc inverter circuit breakers, dual AC inputs, and 230 Vac maintenance bypass assembly. Recommended for systems which have a single Radian inverter and an AC source, but can be customized in other ways.
 - Intended for Radian model GS7048E.
- **GS LC175-PV-120/240** – GS Load Center for PV and AC applications (split-phase). Factory-prepared with dual 175 Adc inverter circuit breakers, dual AC inputs, 120/240 Vac maintenance bypass assembly, two PV array inputs, PV GFDI, FLEXnet DC battery monitor, and three shunts. Intended as a “plug-and-play” solution for systems with a single inverter, two FLEXmax 60 or FLEXmax 80 charge controllers, and battery monitoring.
 - Intended for Radian models GS8048 and GS8048A and 150 Vdc charge controllers.
- **GS LC-PV-300VDC** – GS Load Center for PV and AC applications (split-phase). Factory-prepared with dual 175 Adc inverter circuit breakers, dual AC inputs, 120/240 Vac maintenance bypass assembly, two PV array inputs, FLEXnet DC battery monitor, and three shunts. Intended as a “plug-and-play” solution for systems with a single inverter, two FLEXmax 100 charge controllers, and battery monitoring.
 - Intended for Radian models GS8048 and GS8048A and 300 Vdc charge controllers.
- **GS LC175-PV-230** – GS Load Center for PV and AC applications (single-phase). Factory-prepared with dual 175 Adc inverter circuit breakers, dual AC inputs, 230 Vac maintenance bypass assembly, two PV array inputs, PV GFDI, FLEXnet DC battery monitor, and three shunts. Intended as a “plug-and-play” solution for systems with a single inverter, two FLEXmax 60 or FLEXmax 80 charge controllers, and battery monitoring.
 - Intended for Radian model GS7048E and 150 Vdc charge controllers.
- **GS LC-PV-300VDC-230** – GS Load Center for PV and AC applications (single-phase). Factory-prepared with dual 175 Adc inverter circuit breakers, dual AC inputs, 230 Vac maintenance bypass assembly, two PV array inputs, FLEXnet DC battery monitor, and three shunts. Intended as a “plug-and-play” solution for systems with a single inverter, two FLEXmax 100 charge controllers, and battery monitoring.
 - Intended for Radian model GS7048E and 300 Vdc charge controllers.
- **GS LC175PV1-120/240** — GS Load Center for PV and AC applications (split-phase). Factory-prepared with one 175 Adc inverter circuit breaker, dual AC inputs, 120/240 Vac maintenance bypass assembly, one PV array input, PV GFDI, FLEXnet DC battery monitor, and two shunts. Intended as a “plug-and-play” solution for systems with a single inverter, one FLEXmax 60 or FLEXmax 80 charge controller, and battery monitoring.
 - Intended for Radian model GS4048A and 150 Vdc charge controllers.
- **GS LC-PV1-300VDC** — GS Load Center for PV and AC applications (split-phase). Factory-prepared with one 175 Adc inverter circuit breaker, dual AC inputs, 120/240 Vac maintenance bypass assembly, one PV array input, FLEXnet DC battery monitor, and two shunts. Intended as a “plug-and-play” solution for systems with a single inverter, one FLEXmax 100 charge controller, and battery monitoring.
 - Intended for Radian model GS4048A and 300 Vdc charge controllers.
- **GS LC175PV1-230** — GS Load Center for PV and AC applications (single-phase). Factory-prepared with one 175 Adc inverter circuit breaker, dual AC inputs, 230 Vac maintenance bypass assembly, one PV array input, PV GFDI, FLEXnet DC battery monitor, and two shunts. Intended as a “plug-and-play” solution for systems with a single inverter, one FLEXmax 60 or FLEXmax 80 charge controller, and battery monitoring.
 - Intended for Radian model GS3548E and 150 Vdc charge controllers.

- **GSLCPV1-300VDC-230** — GS Load Center for PV and AC applications (single-phase). Factory-prepared with one 175 A dc inverter circuit breaker, dual AC inputs, 230 Vac maintenance bypass assembly, one PV array input, FLEXnet DC battery monitor, and two shunts. Intended as a “plug-and-play” solution for systems with a single inverter, one FLEXmax 100 charge controller, and battery monitoring.
 - Intended for Radian model GS3548E and 300 Vdc charge controllers.



The enclosure provides mounting holes for the HUB Communications Manager on the left. On the right, the enclosure has mounting holes for brackets to mount up to two FLEXmax charge controllers.

NOTE: OutBack FLEXmax 100 charge controllers do not mount directly to the GSLC and do not require additional mounting brackets. They are mounted beside the inverter or the GSLC. See the inverter *Installation Manual* for more information.

Figure 2 GS Load Center with Devices

GSLC – Components

Legend

- 1 Inverter Negative (-) DC Bus Bars
- 2 Negative (-) Terminal Bus Bar (TBB-WHITE)
- 3 Ground TBB (TBB-GROUND)
- 4 Neutral TBB (TBB-WHITE)
- 5 PV Positive (+) TBB (TBB-RED)
- 6 Shunt (FW-SHUNT500)

NOTE: The installed Neutral TBB has white insulators (TBB-WHITE). A set of blue insulators (TBB-BLUE) is included in the kit for locations where blue is standard.

The DC Positive (+) Bus Plate (FW-BBUS) and the other inverter positive (+) DC bus bars are also included in the kit.

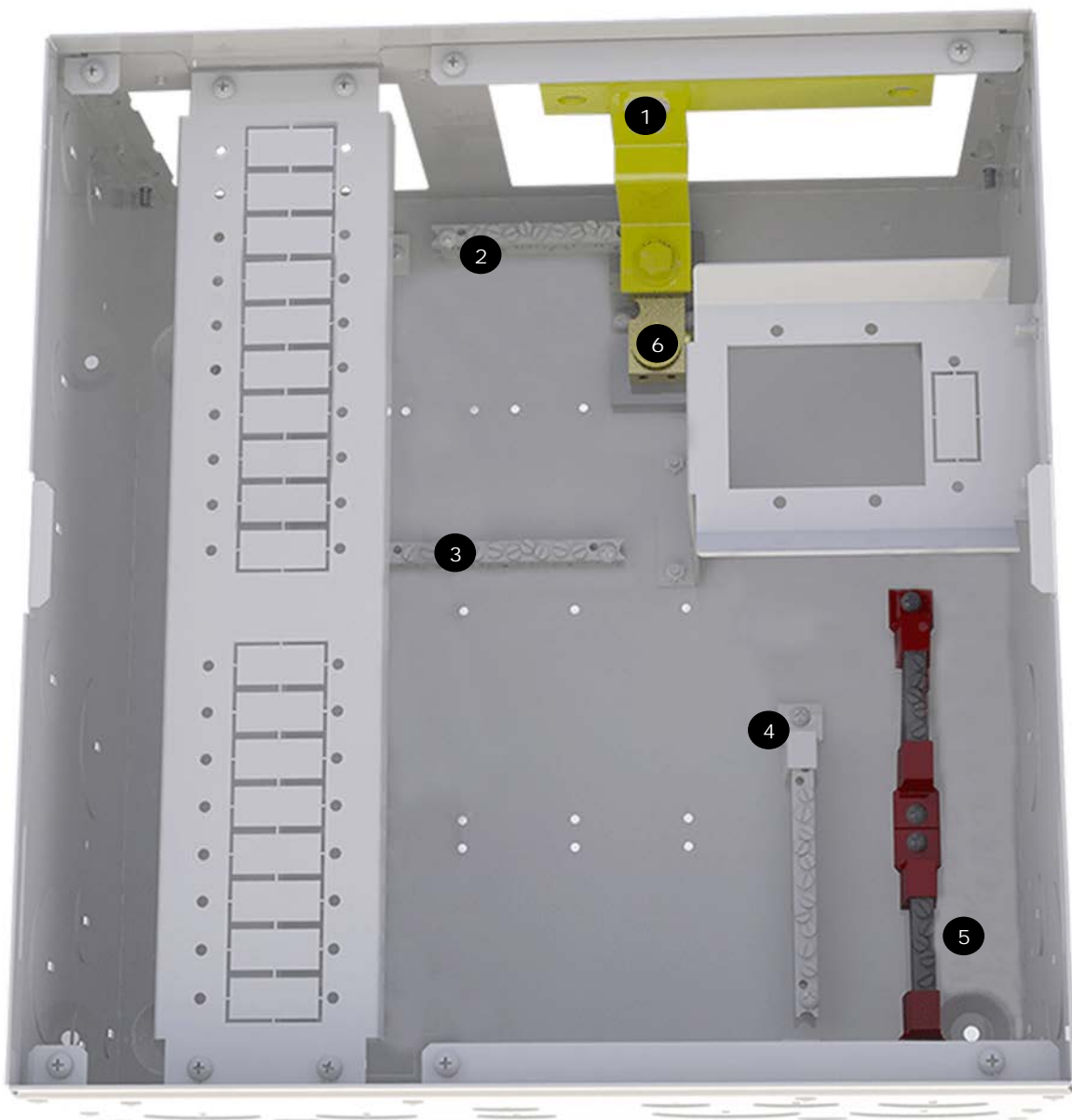
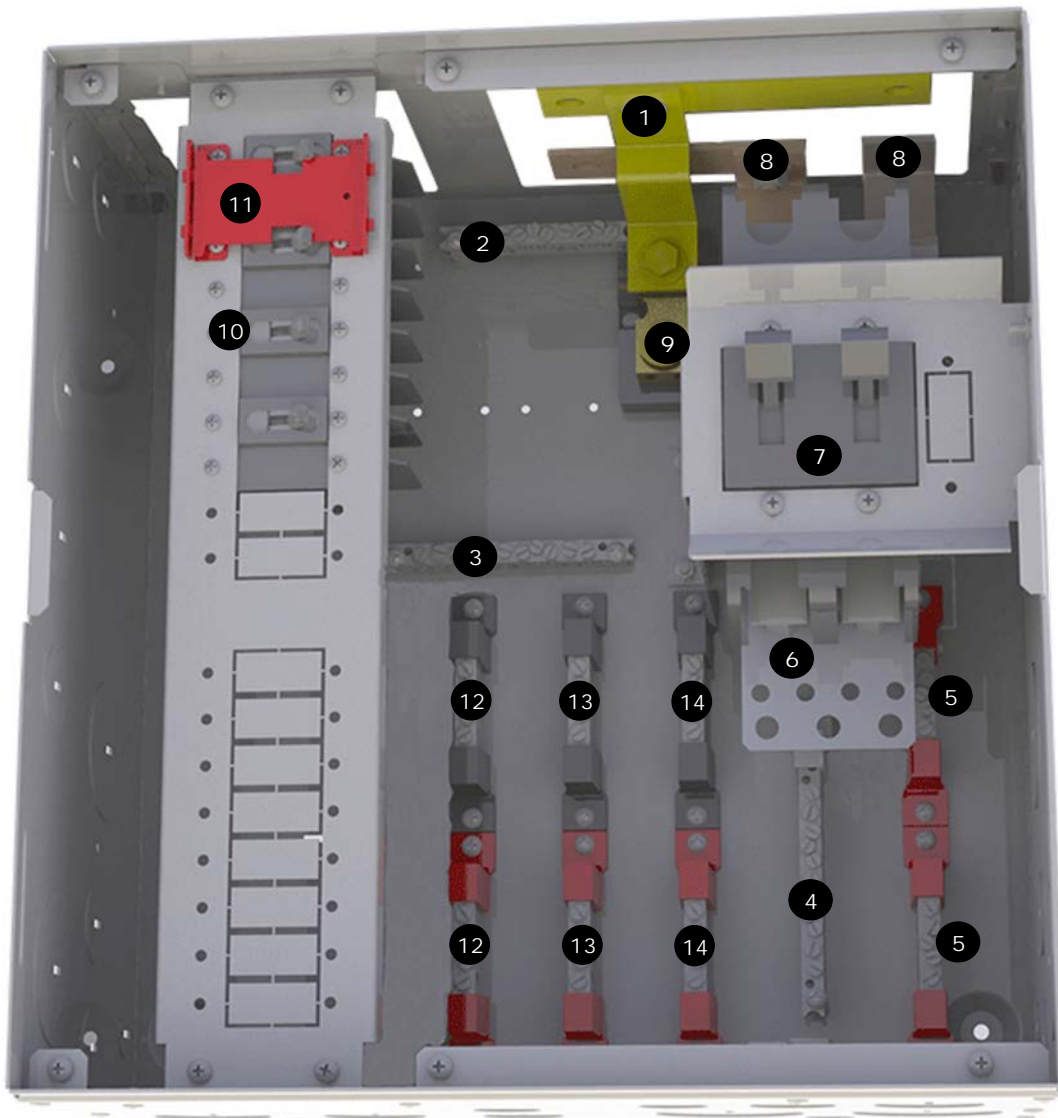

Figure 3 GSLC Components

GSLC175-120/240 – Components

Legend

- | | |
|---|--|
| 1 Inverter Negative (-) DC Bus Bar | 8 Inverter Positive (+) DC Bus Bar |
| 2 Negative (-) Terminal Bus Bar (TBB-WHITE) | 9 Shunt (FW-SHUNT500) |
| 3 Ground TBB (TBB-GROUND) | 10 AC Input Circuit Breakers (PNL-50D-AC-120/240V) |
| 4 Neutral TBB (TBB-WHITE) | 11 Maintenance Bypass Interlock |
| 5 PV Positive (+) TBB (TBB-RED) | 12 AC TBB (Inverter Output) L1, L2 (STBB-RED or BLACK) |
| 6 DC Positive (+) Cable Plate (FW-BBUS) | 13 AC TBB (Grid) L1, L2 (STBB-RED or BLACK) |
| 7 Main Inverter Disconnect(s) (PNL-175-DC) | 14 AC TBB (Generator) L1, L2 (STBB-RED or BLACK) |



NOTE: The factory wiring has been omitted from this illustration for clarity.

Figure 4 GSLC175-120/240 Components

GSLC175-230 – Components

Legend

- | | |
|---|---|
| 1 Inverter Negative (-) DC Bus Bar | 8 Inverter Positive (+) DC Bus Bar |
| 2 Negative (-) Terminal Bus Bar (TBB-WHITE) | 9 Shunt (FW-SHUNT500) |
| 3 Ground TBB (TBB-GROUND) | 10 AC Input Circuit Breakers (PNL-50-AC-230V) |
| 4 Neutral TBB (TBB-BLUE) | 11 Maintenance Bypass Interlock |
| 5 PV Positive (+) TBB (TBB-RED) | 12 AC TBB (Inverter Output) (TBB-BROWN) |
| 6 DC Positive (+) Cable Plate (FW-BBUS) | 13 AC TBB (Grid) (TBB-BROWN) |
| 7 Main Inverter Disconnect(s) (PNL-175-DC) | 14 AC TBB (Generator) (TBB-BROWN) |

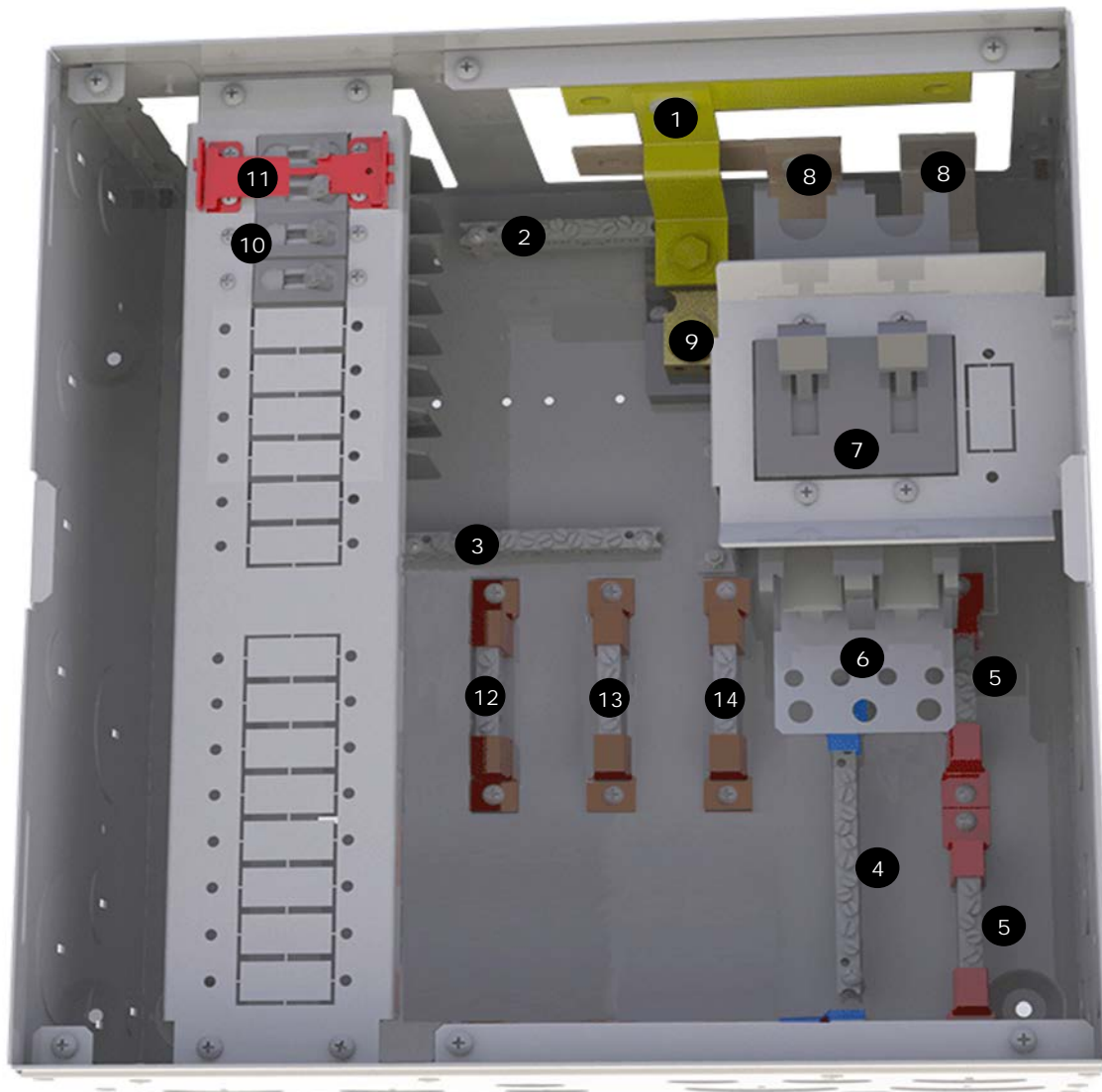

NOTE: The factory wiring has been omitted from this illustration for clarity.

Figure 5 GSLC175-230 Components

GSLC175-PV-120/240 and GSLC-PV-300VDC – Components

Legend

- | | |
|---|---|
| 1 Inverter Negative (-) DC Bus Bar | 10 AC Input Circuit Breakers (PNL-50D-AC-120/240V) |
| 2 Negative (-) Terminal Bus Bar (TBB-WHITE) | 11 Maintenance Bypass Interlock |
| 3 Ground TBB (TBB-GROUND) | 12 AC TBB (Inverter Output) L1, L2 (STBB-RED or BLACK) |
| 4 Neutral TBB (TBB-WHITE) | 13 AC TBB (Grid) L1, L2 (STBB-RED or BLACK) |
| 5 PV Positive (+) TBB (TBB-RED) | 14 AC TBB (Generator) L1, L2 (STBB-RED or BLACK) |
| 6 DC Positive (+) Cable Plate (FW-BBUS) | 15 PV Input Disconnects (PNL-80-DC or PNL-80-300VDC) |
| 7 Main Inverter Disconnect(s) (PNL-175-DC) | 16 Shunt Bus (GS-SBUS) |
| 8 Inverter Positive (+) DC Bus Bar | 17 Battery Monitor (FN-DC) |
| 9 Shunt (FW-SHUNT500) | 18 Ground Fault Detector / Charge Controller Disconnect (GSLC-PV-300VDC has PNL-125-300VDC) |

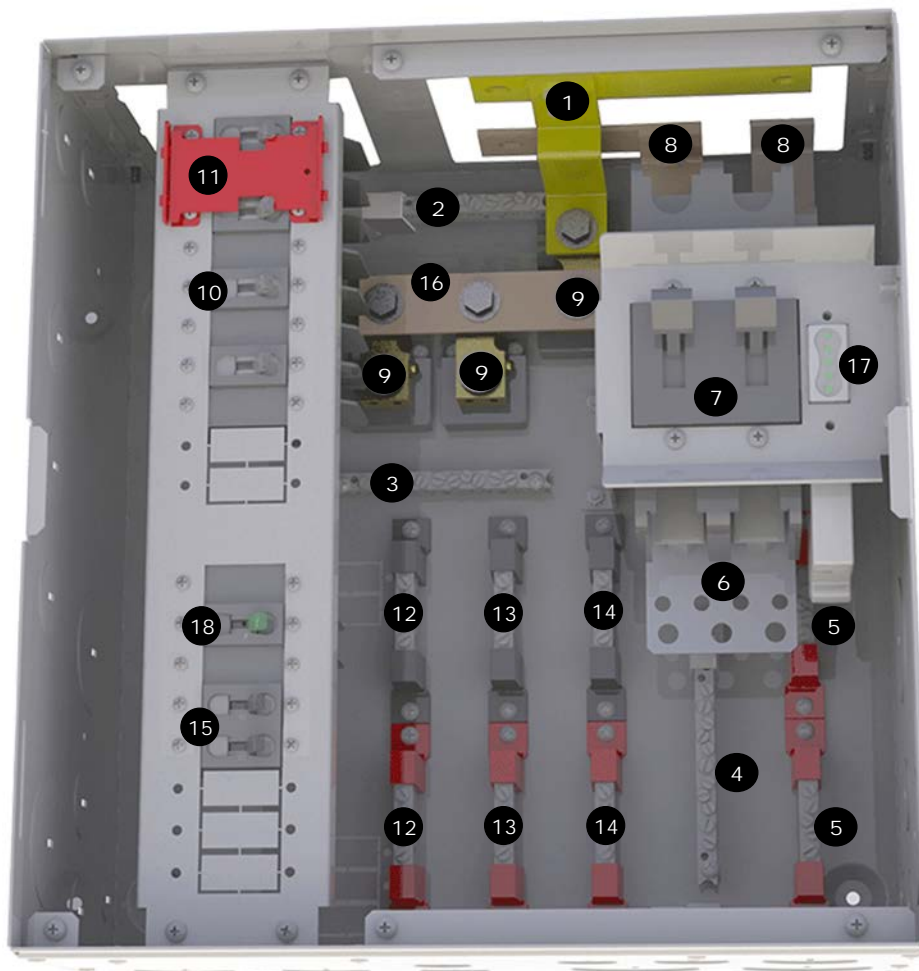

NOTE: The factory wiring has been omitted from this illustration for clarity.

Figure 6 GSLC175-PV-120/240 Components

GSLC175-PV-230 and GSLC-PV-300VDC-230 – Components

Legend

- | | | | |
|---|---|----|--|
| 1 | Inverter Negative (-) DC Bus Bar | 10 | AC Input Circuit Breakers (PNL-50-AC-230V) |
| 2 | Negative (-) Terminal Bus Bar (TBB-WHITE) | 11 | Maintenance Bypass Interlock |
| 3 | Ground TBB (TBB-GROUND) | 12 | AC TBB (Inverter Output) (TBB-BROWN) |
| 4 | Neutral TBB (TBB-BLUE) | 13 | AC TBB (Grid) (TBB-BROWN) |
| 5 | PV Positive (+) TBB (TBB-RED) | 14 | AC TBB (Generator) (TBB-BROWN) |
| 6 | DC Positive (+) Cable Plate (FW-BBUS) | 15 | PV Input Disconnects (PNL-80-DC or PNL-80-300VDC) |
| 7 | Main Inverter Disconnect(s) (PNL-175-DC) | 16 | Shunt Bus (GS-SBUS) |
| 8 | Inverter Positive (+) DC Bus Bar | 17 | Battery Monitor (FN-DC) |
| 9 | Shunt (FW-SHUNT500) | 18 | Ground Fault Detector / Charge Controller Disconnect (GSLC-PV-300VDC-230 has PNL-125-300VDC) |

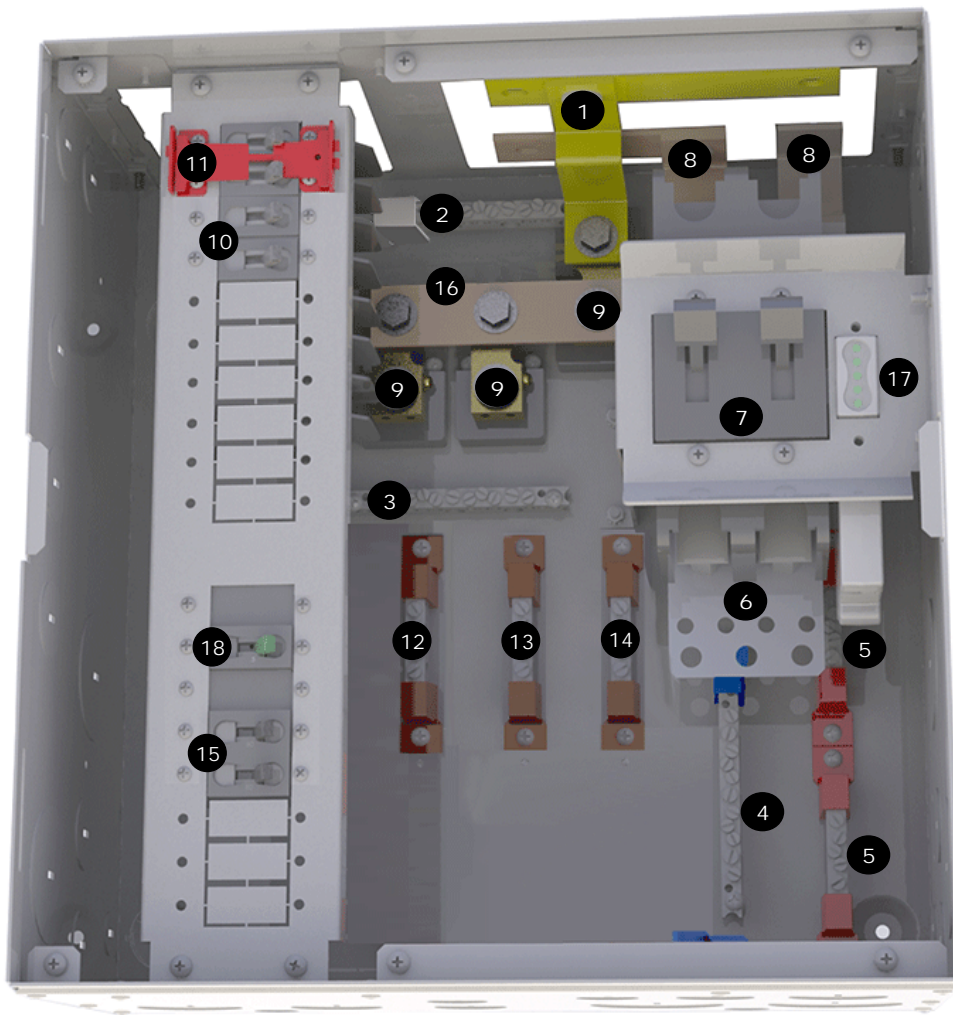

NOTE: The factory wiring has been omitted from this illustration for clarity.

Figure 7 GSLC175-PV-230 Components

GSLC175PV1-120/240 and GSLC-PV1-300VDC – Components

Legend

- | | |
|---|--|
| 1 Inverter Negative (-) DC Bus Bar | 10 Maintenance Bypass Interlock |
| 2 Negative (-) Terminal Bus Bar (TBB-WHITE) | 11 AC TBB (Inverter Output) L1, L2 (STBB-RED or BLACK) |
| 3 Ground TBB (TBB-GROUND) | 12 AC TBB (Grid) L1, L2 (STBB-RED or BLACK) |
| 4 Neutral TBB (TBB-WHITE) | 13 AC TBB (Generator) L1, L2 (STBB-RED or BLACK) |
| 5 PV Positive (+) TBB (TBB-RED) | 14 PV Input Disconnect (PNL-80-DC or PNL-80-300VDC) |
| 6 Main Inverter Disconnect (PNL-175-DC) | 15 Shunt Bus (GS-SBUS) |
| 7 Inverter Positive (+) DC Bus Bar | 16 Battery Monitor (FN-DC) |
| 8 Shunt (FW-SHUNT500) | 17 Ground Fault Detector / Charge Controller Disconnect (GSLC-PV1-300VDC has PNL-125-300VDC) |
| 9 AC Input Circuit Breakers (PNL-50D-AC-120/240V) | |

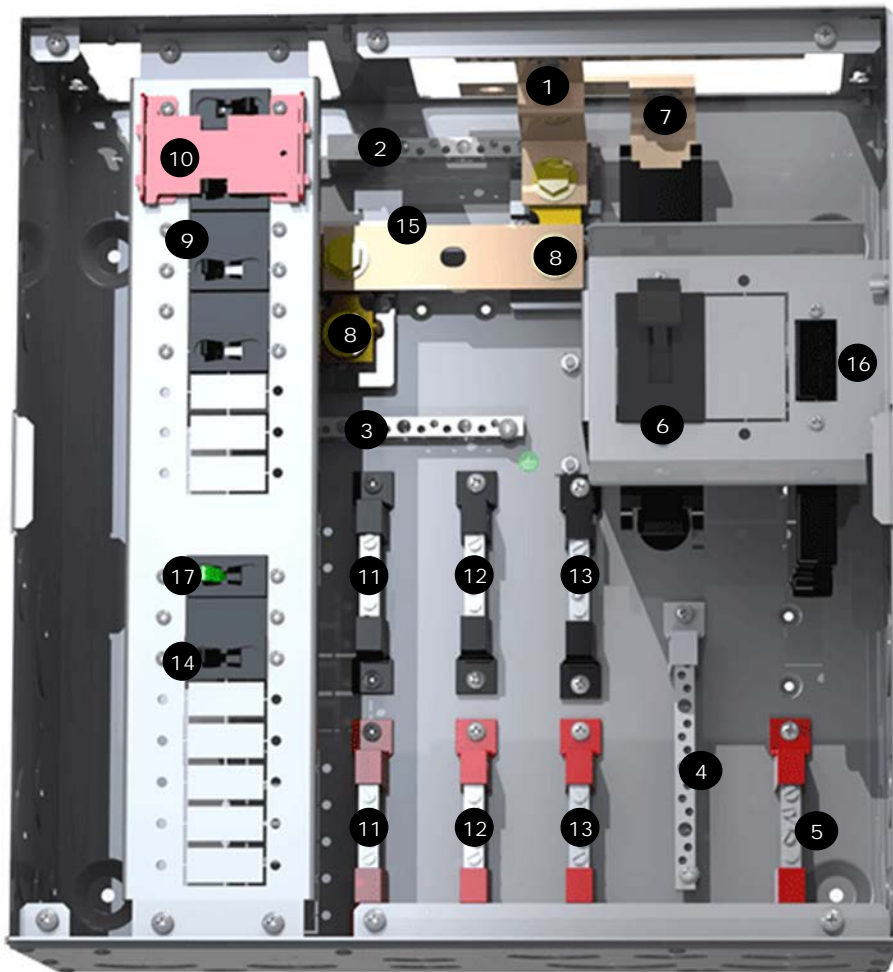

NOTE: The factory wiring has been omitted from this illustration for clarity.

Figure 8 GSLC175PV1-120/240 Components

GSLC175PV1-230 and GSLCPV1-300VDC-230 – Components

Legend

- | | | | |
|---|--|----|---|
| 1 | Inverter Negative (-) DC Bus Bar | 10 | Maintenance Bypass Interlock |
| 2 | Negative (-) Terminal Bus Bar (TBB-WHITE) | 11 | AC TBB (Inverter Output) (TBB-BROWN) |
| 3 | Ground TBB (TBB-GROUND) | 12 | AC TBB (Grid) (TBB-BROWN) |
| 4 | Neutral TBB (TBB-WHITE) | 13 | AC TBB (Generator) (TBB-BROWN) |
| 5 | PV Positive (+) TBB (TBB-RED) | 14 | PV Input Disconnect (PNL-80-DC or PNL-80-300VDC) |
| 6 | Main Inverter Disconnect (PNL-175-DC) | 15 | Shunt Bus (GS-SBUS) |
| 7 | Inverter Positive (+) DC Bus Bar | 16 | Battery Monitor (FN-DC) |
| 8 | Shunt (FW-SHUNT500) | 17 | Ground Fault Detector / Charge Controller Disconnect (GSLVPV1-300 VDC-230 has PNL-125-300VDC) |
| 9 | AC Input Circuit Breakers (PNL-50-AC-230V) | | |

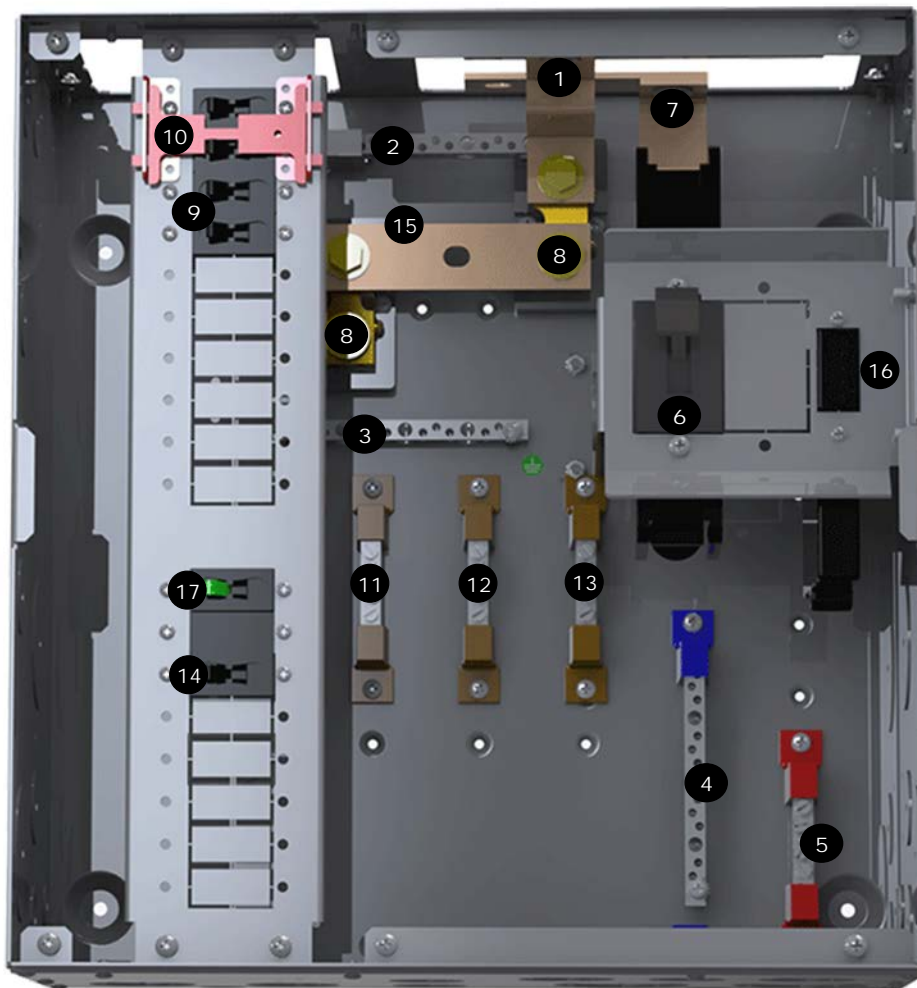

NOTE: The factory wiring has been omitted from this illustration for clarity.

Figure 9 GSLC175PV1-230 Components



Planning

Tools Required

- Open-ended wrenches (7/16", 9/16" and 13 mm)
- Wire cutters/strippers
- Torque wrenches
- Assorted insulated screwdrivers
- Digital Voltmeter (DVM) or regular voltmeter

Materials Required

- Conductors for wiring
- Conduits

Location/Environmental Requirements

- Indoor mount only

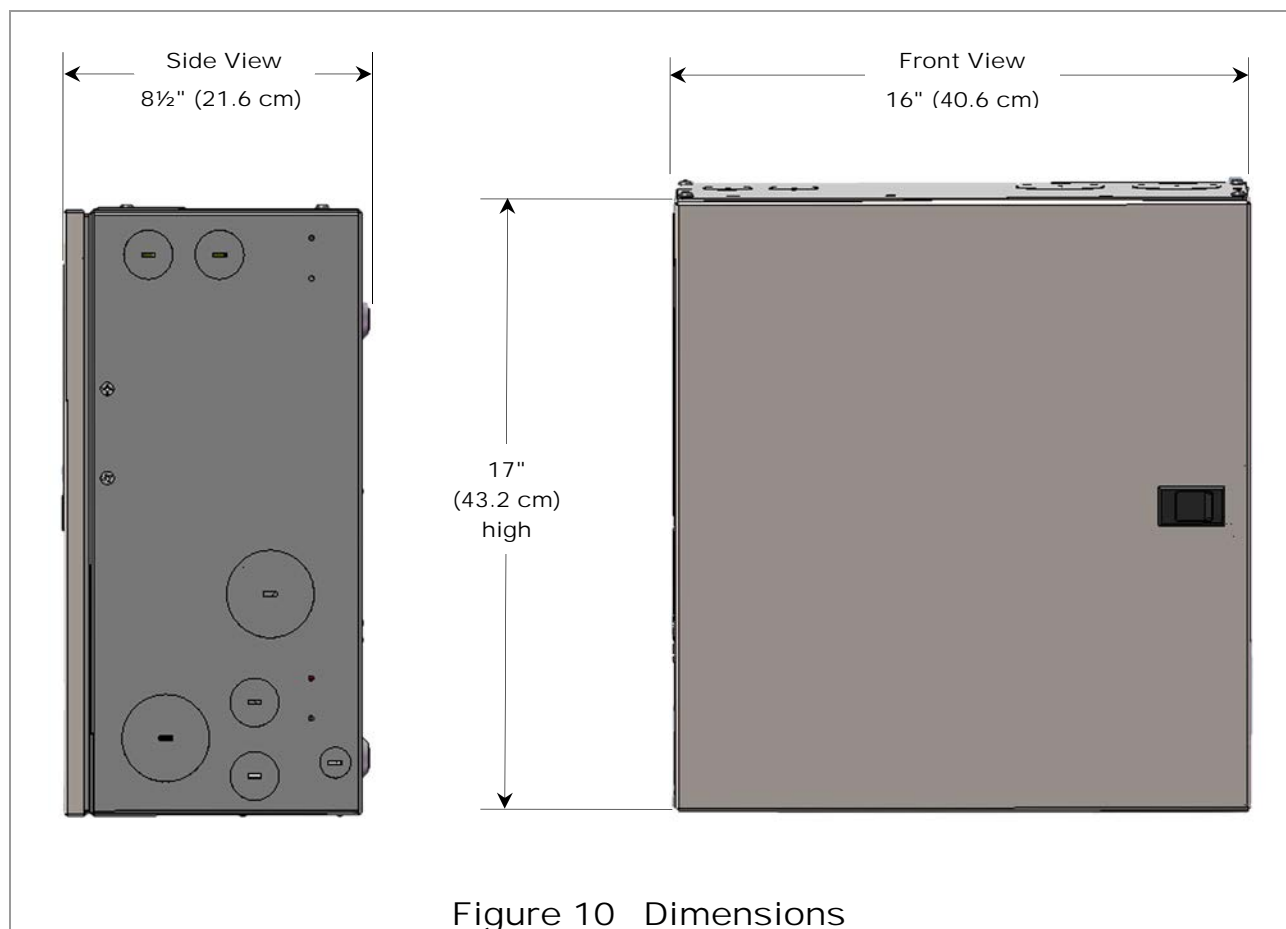

Legend

Cable Knockouts
(U.S. Trade Size or Metric Trade Size)

- ① 2" or 63 mm
- ② 1½" or 50 mm
- ③ 1¼" or 40 mm
- ④ 1" or 32 mm
- ⑤ ½" or 20 mm

⑦ Mounting holes for HUB product

⑧ Mounting holes for FW-CCB and FW-CCB2 brackets

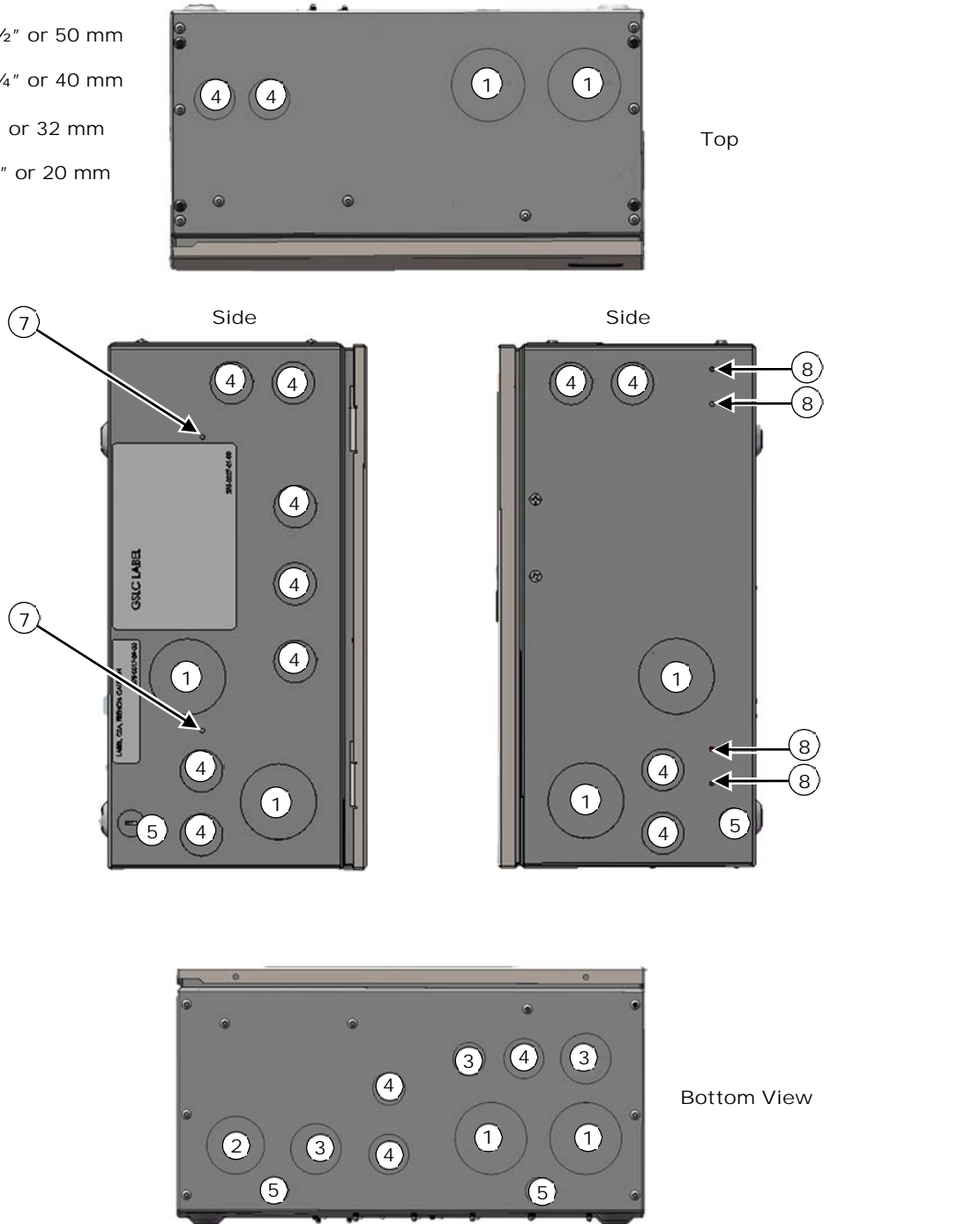

Figure 11 Knockouts and Mounting Holes for Devices



Installation

Hardware Options

Different versions of the GSLC come with different components already installed.

- GSLC, the “basic” or “empty” version, requires almost all components to be installed if they are needed. Instructions for this product begin on page 22.
- GSLC175-120/240 and GSLC175-230 are the “inverter only” versions for Radian models GS8048, GS8048A, and GS7048E. They have hardware for Radian inverter AC and DC connections. Battery monitoring or PV capability must be installed as needed. Installation for these items begins with the DC shunts on page 26.
- GSLC175-PV-120/240, GSLC175-PV-230, GSLC-PV-300VDC, and GSLC-PV-300VDC-230 are the “fully-loaded” versions for Radian models GS8048, GS8048A, and GS7048E. They have all options already present and need only external wiring and devices added. Users with these versions can skip to the wiring section on page 33.
- GSLC175PV1-120/240, GSLC175PV1-230, GSLC-PV1-300VDC, and GSLCPV1-300VDC-230 are the “fully-loaded” versions for Radian models GS4048A and GS3548E. They have all options already present and need only external wiring and devices added. Users with these versions can skip to the wiring section on page 33.

Additional AC and DC circuit breakers are available for installation on all models.

The following pages describe the installation of individual items, including the removal of the GSLC covers. Page 22 lists the hardware requirements for these items.

- Instructions for Radian inverter mounting (along with other devices) begin on page 28.
- Instructions for installing the FLEXnet DC battery monitor begin on page 37.
- Instructions for installing the AC input-output bypass (IOB) assembly begin on page 47.

The following components are sold separately for the GSLC:

- Inverter Main Disconnects (required for inverter installations)
- AC Maintenance Bypass Assembly
- AC Terminal Bus Bars (TBB)
- PV Ground Fault Detector-Interrupter (GFDI)
- FLEXnet DC Battery Monitor (FN-DC); see page 37
- Additional DC shunts and GS-SBUS
- PV Disconnect 80-amp circuit breaker (PNL-80-DC)



Figure 12 GSLC – Additional Components

Installation

The following components are sold separately for the GSLC175-120/240 and GSLC175-230:

- PV Ground Fault Detector-Interrupter (GFDI)
- FLEXnet DC Battery Monitor (FN-DC); see page 37
- Additional DC shunts and GS-SBUS
- PV Disconnect 80-amp circuit breaker (PNL-80-DC)

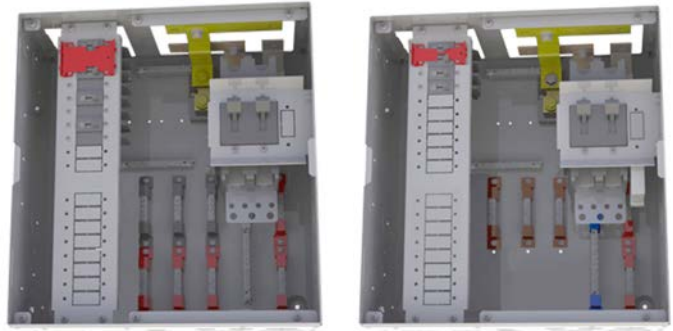
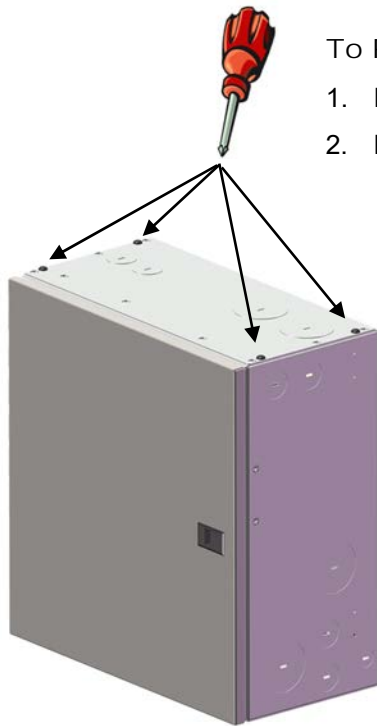

Figure 13 GSLC175-120/240 and GSLC175-230
- Additional Components

Remove Top Cover



To Remove the Top Cover:

1. Remove the four screws; one in each corner.
2. Lift the top off the enclosure.

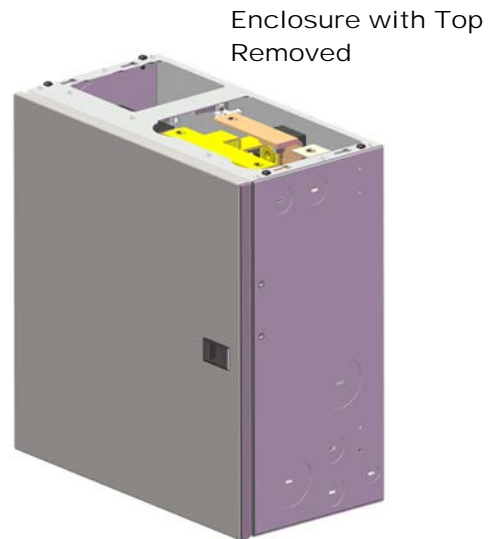

Figure 14 Removing the Top Cover from the GSLC

Remove Front Door

To Remove the Front Door:

1. Open the door to about 90 degrees.
2. Lift the hinges out of the slots at the inside edge.

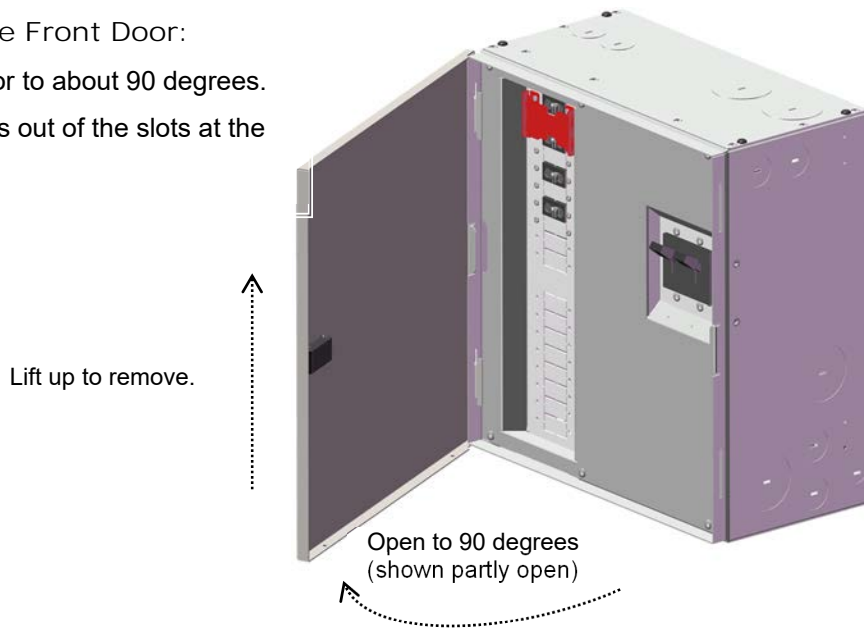

Figure 15 Removing the Front Door from the GSLC

Remove Interior Cover

In order to make any wiring connections or to install components, the interior cover must be removed to expose the enclosure interior. (This cover is sometimes called the “dead front.”)

To Remove the Interior Cover:

1. Remove the three screws along the top of the enclosure (with one star washer).
2. Remove the three screws along the bottom of the enclosure (with one star washer).
3. Lift the front cover off the enclosure.

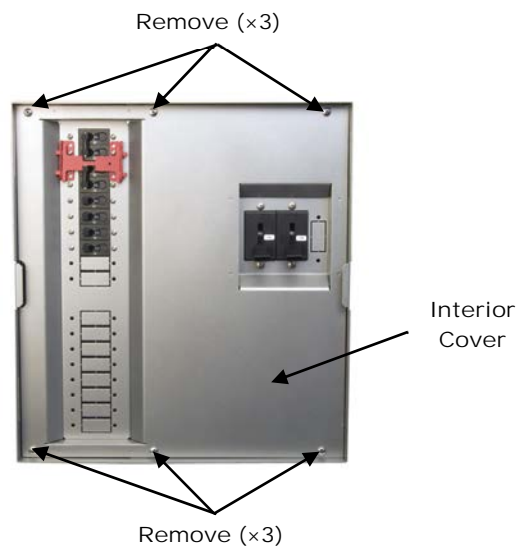

Figure 16 Removing the Interior Cover from the GSLC

Installing the Internal Hardware

Table 1 Requirements for Circuit Breakers and Bus Bars

Item	Terminal/Bolt Size	Torque Requirements
Inverter Positive (+) Bus Bars	M8	60 in-lb (6.8 Nm)
Shunt Bolts	3/8"	60 in-lb (6.8 Nm)
DC Positive (+) Cable Plate	Top Holes (x3)	60 in-lb (6.8 Nm)
	Bottom Holes (x7)	50 in-lb (5.7 Nm)
Circuit Breaker Studs	M8	20 in-lb (2.3 Nm)
	1/4"	35 in-lb (4.0 Nm)
	5/16"	50 in-lb (5.7 Nm)
	3/8"	225 in-lb (25.5 Nm)

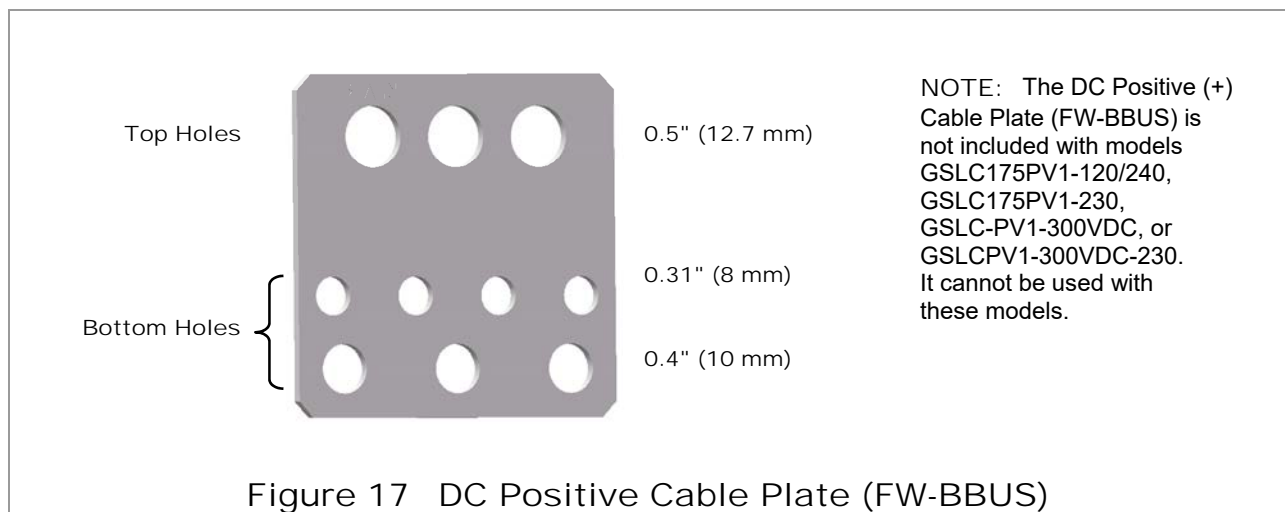

Figure 17 DC Positive Cable Plate (FW-BBUS)

Assembling DC Positive (+) Cable Plate (Bus Bar)

NOTE: These instructions are not used with models GSLC175PV1-120/240, GSLC175PV1-230, GSLC-PV1-300VDC, or GSLCPV1-300VDC-230. If using any of these models, proceed to page 24 or the next appropriate instruction.

The bottom of each DC disconnect (circuit breaker) is bolted to a metal plate (bus bar) which receives the inverter's positive (+) battery cables.

To assemble the DC Positive Plate:

1. Remove the nuts and other hardware (washer, lock washer, hex nut) from the bottom terminal in the back of each DC disconnect.
2. Place the two DC disconnects side by side.
3. Orient the DC positive plate so that the three largest holes are at the top. These holes have a diameter of 0.50" (1.3 cm). Insert the studs on each disconnect through the first and third holes.
4. Replace the disconnect hardware (washer, lock washer, hex nut). Tighten the nuts to the values shown in Table 1 on page 22. The plate will hold the two circuit breakers together as a set.

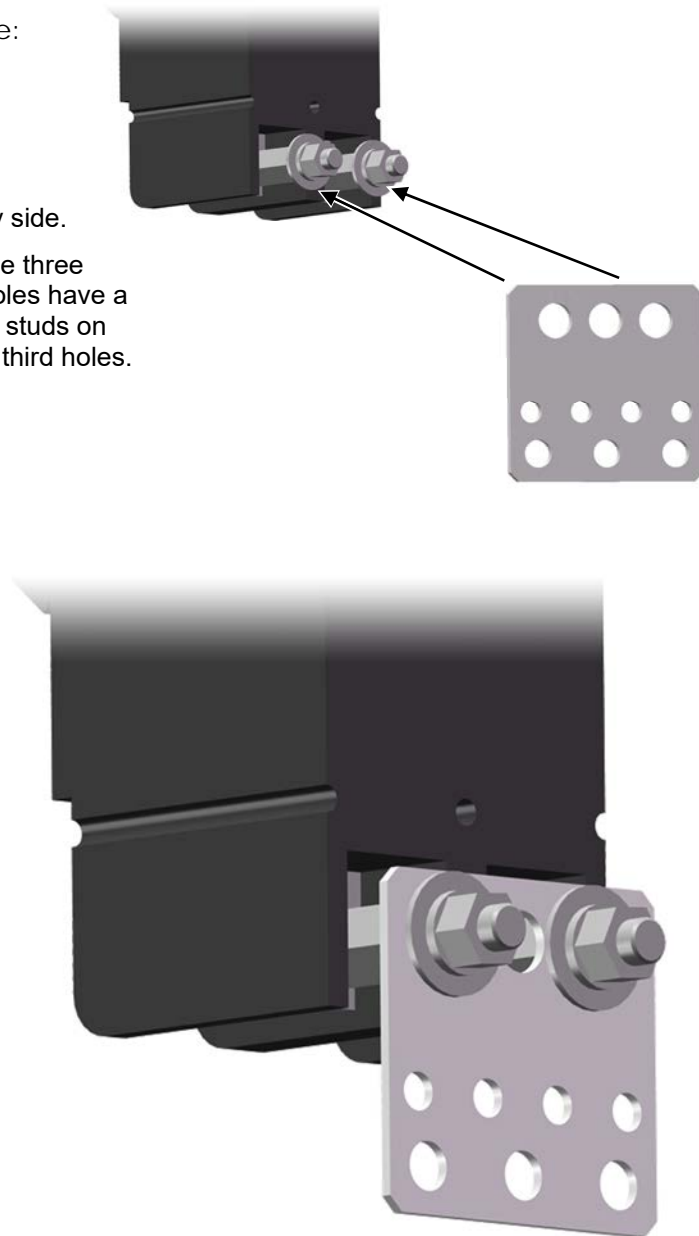
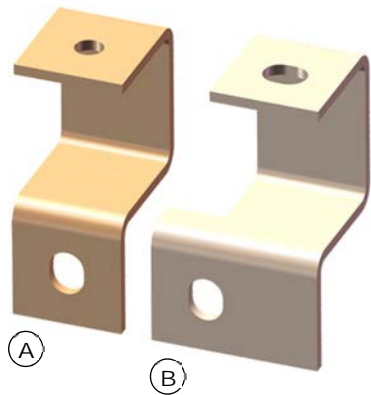

Figure 18 Assembling the DC Positive (+) Cable Plate

Installing Inverter Positive Bus Bars



The GSLC parts kit contains two bus bars, A and B, which attach to the top of each DC disconnect. These bus bars make the connections with the Radian inverter's positive DC terminals. Although they have similar shapes, the bus bars are not interchangeable.

NOTE: Item B is not included with models GSLC175PV1-120/240, GSLC175PV1-230, GSLC-PV1-300VDC, or GSLCPV1-300VDC-230. When these models are in use, begin the instructions with step 2.

To assemble the Inverter Positive (+) Bus Bars:

1. Attach bus bar **B** to the top terminal of the DC disconnect on the right, using the stud and hardware on the back of the DC disconnect. Tighten the nuts to the values shown in Table 1 on page 22.

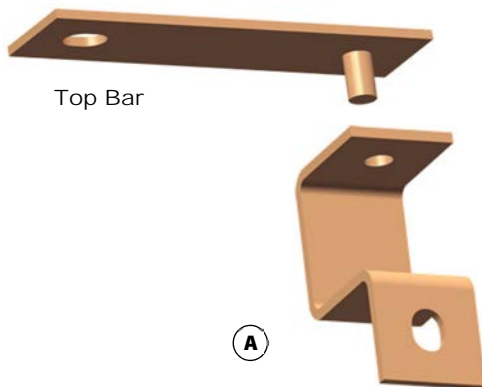
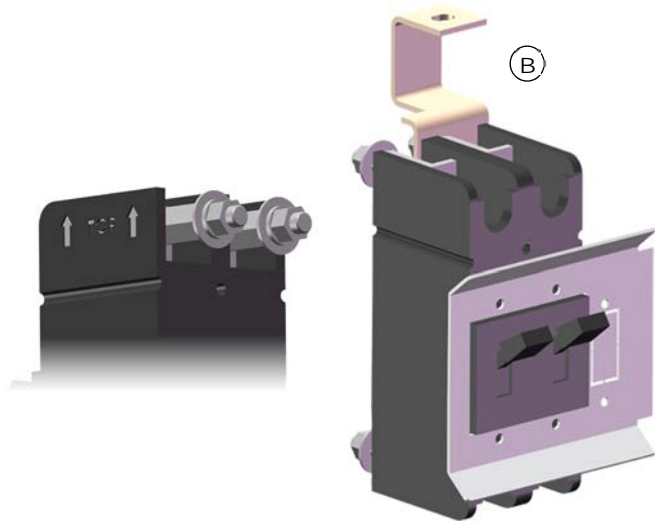

2. The GSLC hardware kit contains a top bar which attaches to bus bar **A**. Attach these two bars together using a 5/16" flat washer, a 5/16" lock washer, and an M8 nut (included in hardware kit). Tighten to the value shown in Table 1 on page 22.

3. Mount bus bar **A** and the top bar to the top terminal of the DC disconnect on the left. Tighten to the value shown in Table 1 on page 22.

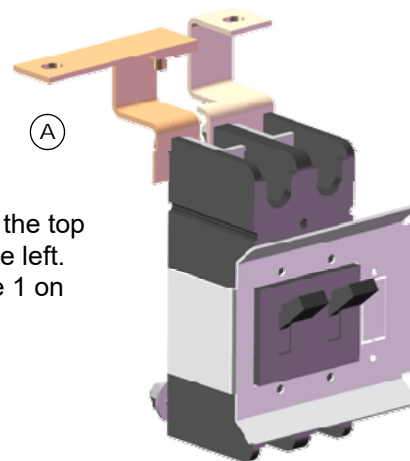
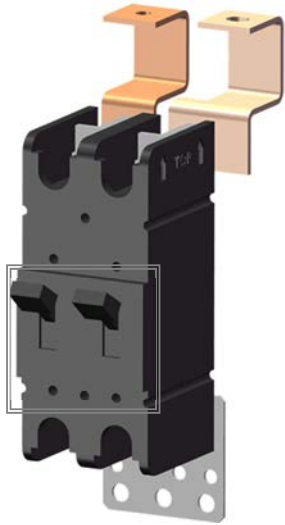

Figure 19 Inverter Bus Bars

Installing Inverter Main DC Disconnects



To mount the inverter main DC disconnects:

1. If the negative top bar is installed, loosen or remove it.
2. Slide the disconnect assembly through the opening in the top of the GSLC and place it behind the premounted bracket. Center the disconnect assembly so that the raised area around the switch protrudes through the bracket. It may be necessary to hold the assembly in place by hand.
3. Take the mounting screws provided with the circuit breaker and insert them from the outside into the GSLC bracket.
4. Tighten until secure, but do not over-tighten.
5. Reattach the negative top bar. Tighten to the value shown in Table 1 on page 22.

Negative Top Bar

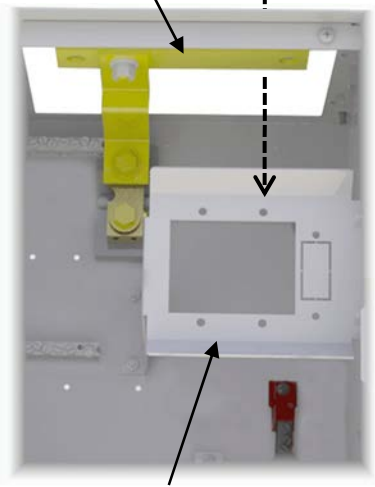

Premounted bracket

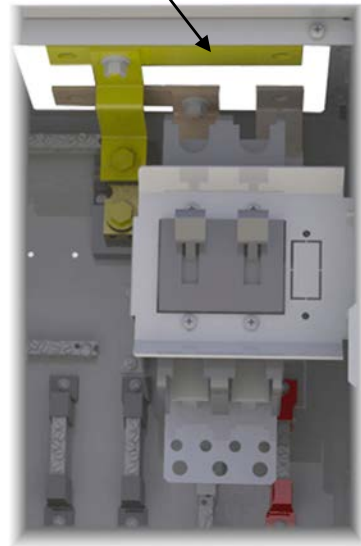
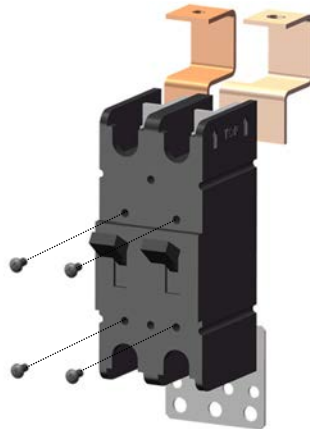

These instructions assume that the GSLC has not yet been mounted to the Radian inverter and that the top is open. If the GSLC's top is closed or inaccessible, remove the premounted bracket. Attach the disconnect assembly to it. Finally, re-install the bracket.

Figure 20 Inverter Main DC Disconnects

Installing DC Shunts



A single 500 Adc/50 mV shunt is included with the GSLC. Up to two more shunts can be installed as needed. These shunts are used in conjunction with the FLEXnet DC battery monitor. See page 35 for more instructions on wiring.

To mount DC Shunts:

1. Four mounting holes are located to the lower left of the first shunt. Center each shunt across one pair of mounting holes. These should line up with the mounting holes built into each shunt.
2. Using the screws included with the shunt, attach each shunt to the GSLC enclosure.
3. Tighten the screws until secure, but do not over-tighten.

NOTE: The GS-SBUS can be purchased and installed to connect the three shunts together. See Figure 30 on page 37.

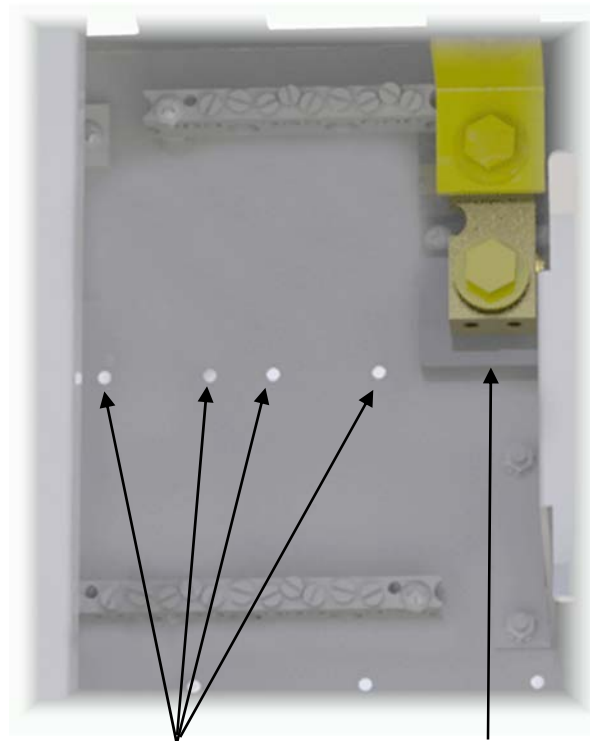

Mounting Holes for Additional Shunts

Pre-installed Shunt

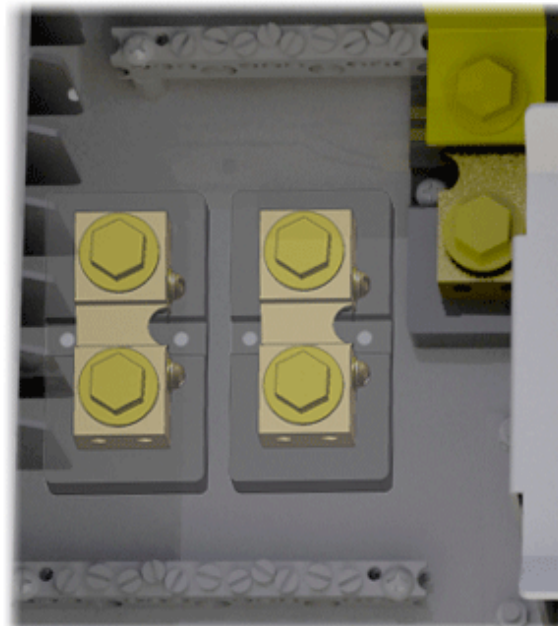

Additional Shunt Placement

Figure 21 DC Shunts

Installing Circuit Breakers and GFDI

To mount circuit breakers:

1. It may be necessary to remove the knockout from the location where the circuit breaker is to be placed to make room for the circuit breaker to be installed. Be sure to remove any debris that may occur from **removing** the knockout.
2. Place each circuit breaker behind the premounted rail. Center the device so that the raised area around the switch protrudes through the bracket. It may be necessary to hold the device in place by hand.
2. When the circuit breaker is in place, insert the screws included with each breaker through the holes in the mounting rail.
3. Tighten the screws until secure, but do not over-tighten.

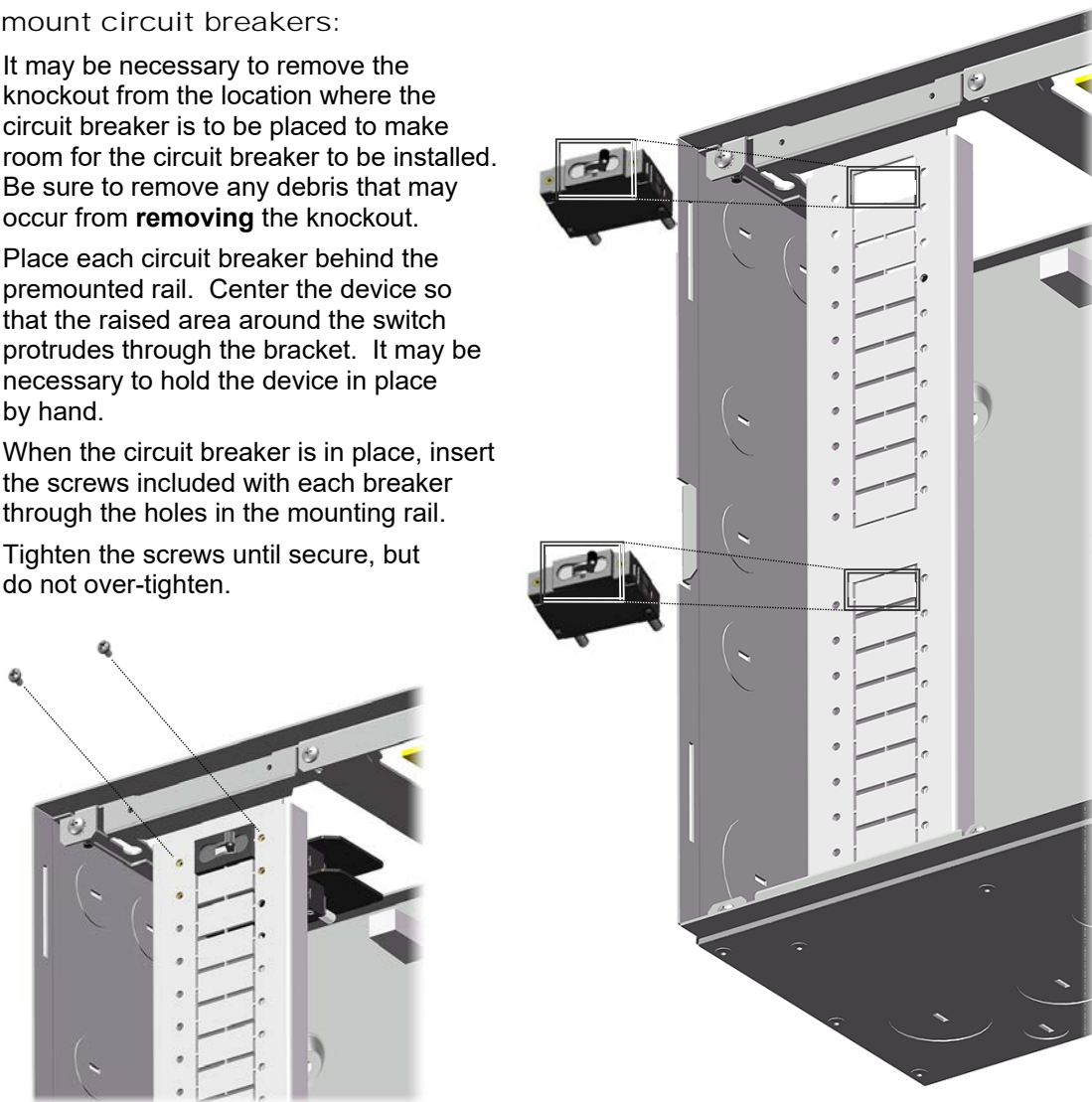

NOTES

- Although there are no specific designations, the upper end of the mounting rail is generally used for AC devices (including the maintenance bypass). The lower end is generally used for DC devices, including the GFDI. The preassembled GSLC models follow this convention.
- A PV ground-fault device may be required. The OutBack GFDI is pre-installed on some models. With other models it can be purchased separately for manual installation. (See page 19.) The GFDI mounts the same way as other circuit breakers. Once mounted, see page 38 and the GFDI manual for wiring instructions. (Note that the GFDI usually requires multiple rail slots.)
- Some installations may require an AC maintenance bypass. This is referred to as the Input-Output Bypass or IOB. The bypass comes prewired for a single Radian inverter in some GSLC versions. It can also be purchased separately. See page 41 and the GS-IOB manual for mounting and wiring instructions.

Figure 22 Circuit Breakers

Mounting on the Inverter



IMPORTANT:

The Radian inverter and GSLC are intended for indoor use only. Ensure the mounting surface is strong enough to support the full weight of the Radian inverter/charger and the GSLC. Use a minimum 3/4" (19 mm) sheet of plywood to strengthen the wall surface if required.

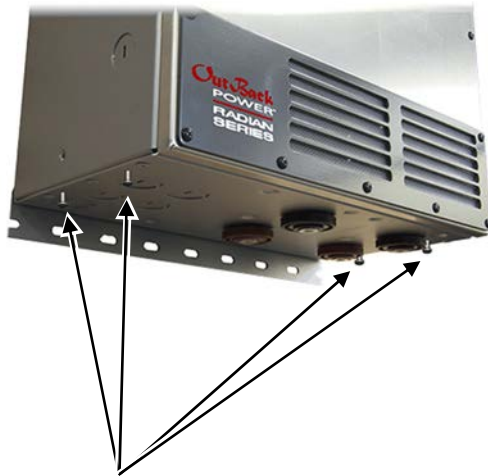

Bottom Screws



Keyhole Slots

Keyhole

To mount the GSLC to the Radian inverter:

1. Install the inverter on the mounting bracket.  Remove knockouts from the bottom of the inverter if necessary and install bushings.
2. Back out bottom screw(s) approximately 1/4" (0.6 cm) to 3/16" (0.5 cm).
3. Remove the front and interior covers from the GSLC if necessary (as described on page 21).
4. Align the GSLC along the bottom of the inverter and slide the bottom screws into the keyhole slots.
5. Hanging the GSLC from the screws and holding it flush against the bottom of the inverter, mark the spots for the holes for the mounting feet. These are located in the rear of the GSLC and are marked below.
6. **If using wall anchors (included):** Remove the GSLC. Using a 3/8" (10 mm) drill bit, drill leader holes for the hardware to be used to secure the GSLC to the surface. Install the wall anchors. If mounting on a solid surface like plywood, this step can be skipped.

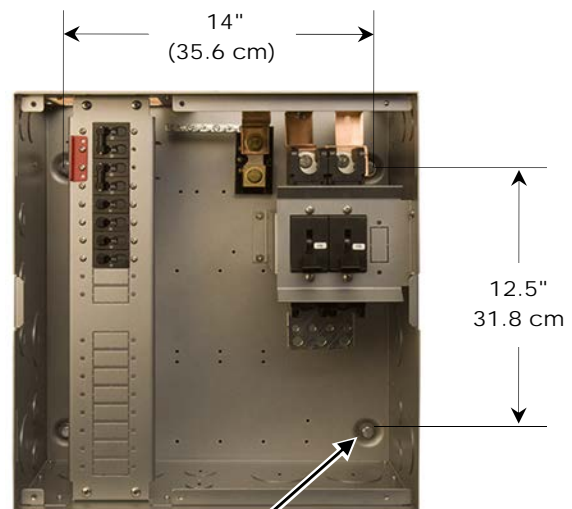

Mounting Feet Holes (x4)

Continued on the next page....

Figure 23 Mounting the GSLC

...continued from the previous page.

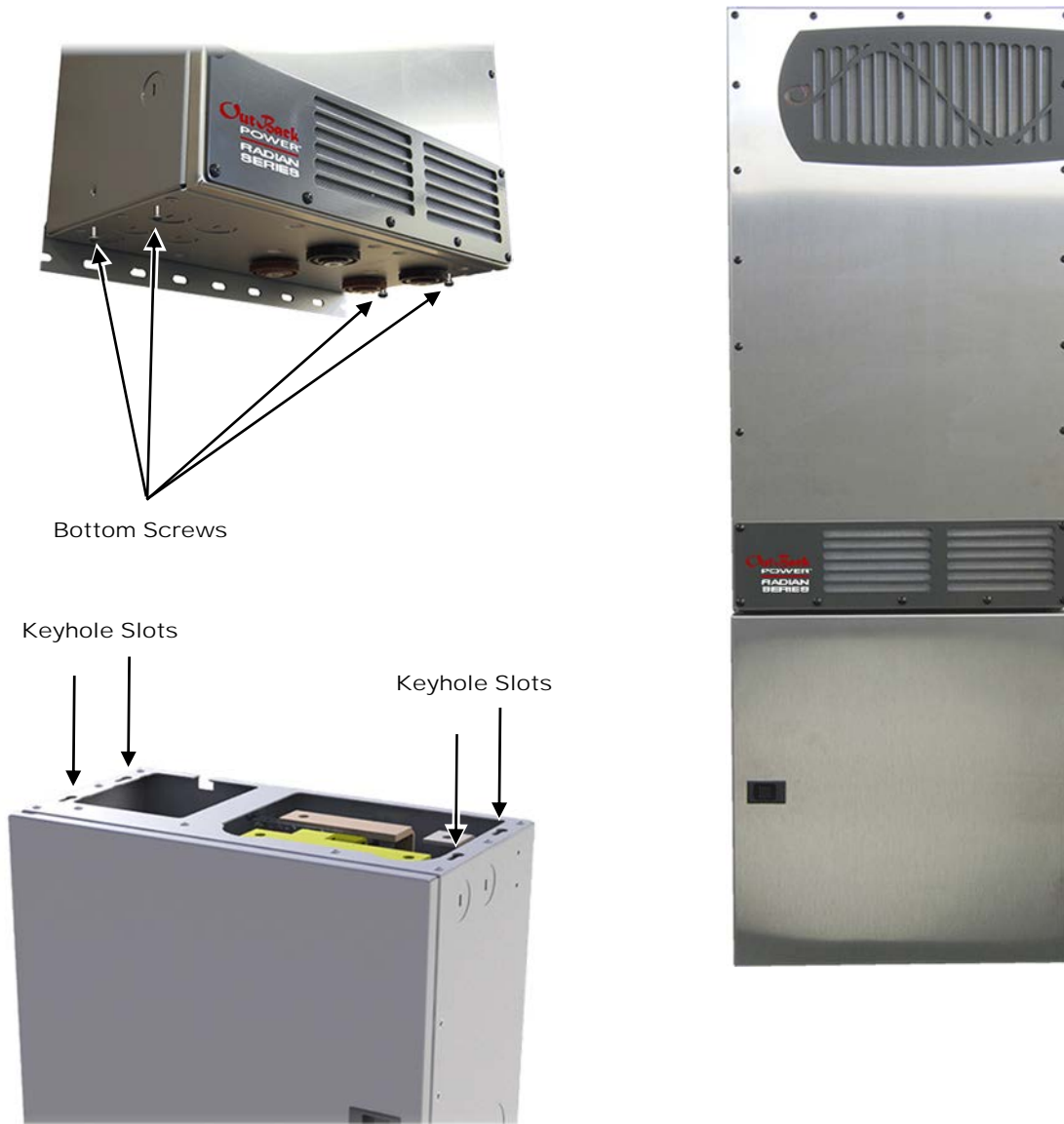

7. Realign the GSLC along the bottom of the inverter and slide the mounting screws into the keyhole slots.
8. Secure the enclosure to the mounting surface using all four mounting feet holes.
9. Using the bolts provided on the Radian inverter's battery terminals, connect the terminals to the GSLC's inverter bus bars. Tighten to the value shown in Table 1 on page 22. For more information on the Radian terminals, see the inverter *Installation Manual*.)
10. Leave the door and interior cover removed until all components have been installed and all wiring is complete.

Figure 23b Mounting the GSLC (continued)

Mounting FLEXmax Charge Controller

The GSLC enclosure accommodates up to two FLEXmax charge controllers and a HUB Communications Manager.

NOTE: The following instructions are for the FLEXmax 60 or FLEXmax 80 only. The FLEXmax 100 charge controller connects directly to the wall and does not need additional brackets.

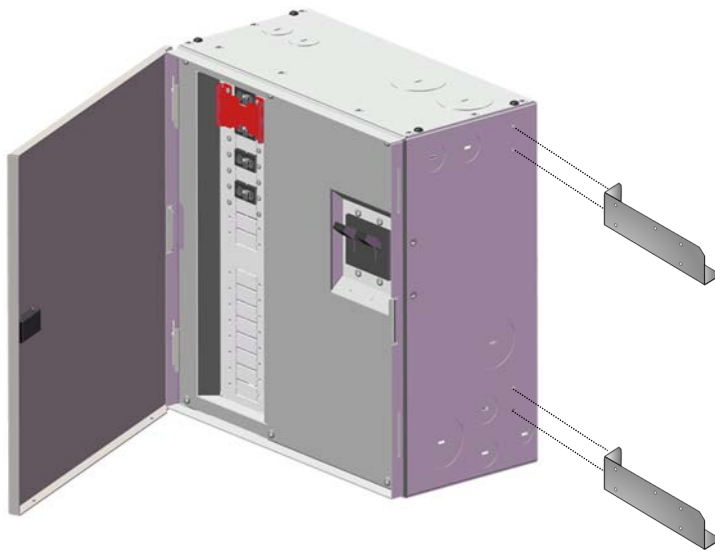

To mount the FLEXmax Charge controller to the side of the GSLC enclosure:

1. Align the brackets to the mounting holes and secure the brackets to the sides of the enclosure with the hardware provided with the brackets.
2. Note the location of knockouts on both the charge controller and the GSLC. (See page 18.) The holes will align when the brackets are used. Remove knockouts if necessary and insert bushings.
3. Align the charge controller with the center hole on each bracket and secure with the hardware provided with the brackets.



4. Secure to the bottom bracket.

NOTE: This illustration shows only brackets for a single charge controller (FW-CCB). Dual charge controller brackets (FW-CCB2) are also available. The installation instructions for FW-CCB and FW-CCB2 are similar.

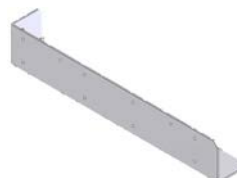

Dual Charge Controller Bracket (FW-CCB2)

Figure 24 Mounting the Charge Controller to the GSLC Enclosure

Mounting the HUB Communications Manager

The GSLC provides mounting holes to support a HUB Communications Manager.

To mount the HUB Communications Manager to the side of the GSLC enclosure:

1. Locate the mounting holes on the side of the GSLC enclosure as shown in Figure 11 on page 18.
2. Remove the knockouts and add bushings.
3. Align the HUB (vertically) over the mounting holes with the HUB product's ports facing forward.
4. Insert the mounting screws from the outside into the GSLC enclosure. The mounting screws are provided with the HUB product.
5. Tighten until secure, but do not over-tighten.
6. Install CAT5 cabling as needed.
7. Install the protective shield for the HUB product.



Figure 25 Mounting the HUB Product to the GSLC Enclosure

Wiring



IMPORTANT:
300 Vdc models require wiring rated for 90°C or greater.

Table 2 Terminal Bus Bar (TBB) Wire Size and Torque Requirements

Conductor Size		Torque Requirements	
AWG	mm ²	In-lb	Nm
#14 – #10	2.5 – 4	20	2.3
#8	6 – 10	25	2.8
#6– #3	16 – 25	35	4.0
#2	35	40	4.5
#1 – 1/0	50	50	5.7

Grounding



WARNING: Shock Hazard

- ❖ The unit must be connected to a permanent wiring system that is grounded according to the IEC 60364 TN standard.
- ❖ Make sure that no more than one bond is present in the AC system at any time. Some codes require the bond to be made at the main panel only.
- ❖ For safety, the neutral and ground conductors should be mechanically bonded. The GSLC Load Center (GSLC) is equipped with a neutral-ground bond. If bonding is required to be in another location, the bond in the GSLC may need to be removed.
- ❖ Some generators have a neutral-ground bond. When establishing a single bond elsewhere, it may be necessary to check for a generator bond.



WARNING: Shock Hazard

For all installations, the negative (-) battery conductor should be bonded to the grounding system at only one point. **The GSLC comes equipped with a negative-ground bond.** This bond may need to be disconnected. If the OutBack GFDI is present, it can provide the bond. See page 34.

The GSLC's grounding terminal bus bar (TBB), which is bonded to the GSLC chassis, is located to the lower left of the main inverter disconnect. It accepts conductor sizes from 1/0 to #14 AWG (50 mm down to 2.5 mm).

This TBB accepts ground connections from the Radian inverter, FLEXmax charge controllers, the OutBack GFDI, the Grounding Electrode Conductor (GEC) or external earth ground, and other equipment.

See the inverter *Installation Manual* for recommendations on ground conductor sizing. Once the size is determined, see Table 2 for required torque values.

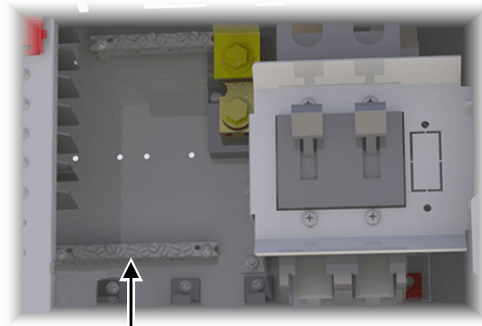

Ground TBB

Figure 26 Grounding

Bonding

All GSLC models, including those in prewired applications, are equipped with a mechanical bond between AC neutral and ground.

Some models are equipped with a mechanical bond between DC negative and ground. These can be useful in stand-alone systems where no other bond is provided. If other bonds are present, or if a GFDI is installed later, the GSLC bond needs to be removed.



WARNING: Shock Hazard

If the GFDI is manually installed (see page 27 and the GFDI manual), the negative-ground bond on the GSLC must be removed. This must also be done if any other PV ground-fault device is present that establishes its own negative-ground bond.



NOTE:

Models equipped with a GFDI do not include the mechanical bond inside the housing, as the GFDI provides a bond instead. The 300 Vdc models do not include an internal bond, as they are intended to be used with charge controllers that have GFDI protection built in.

The GSLC's neutral bus bar is located in the lower right portion of the GSLC. The neutral-ground bond is established at one end of the bar, near the base of the GSLC.

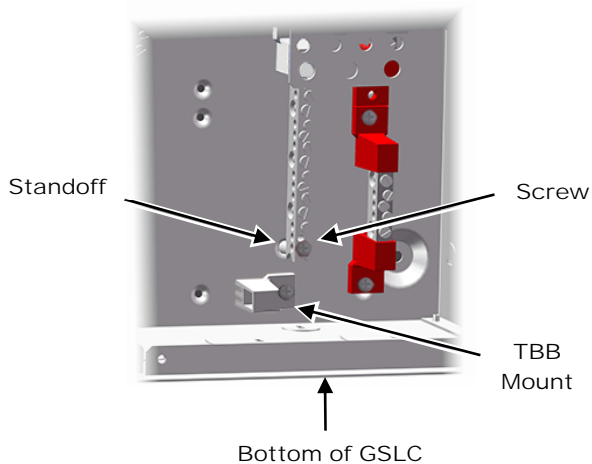

Neutral-Ground Bond

The GSLC's negative (-) bus bar is located near the top of the GSLC. It is attached to the inverter negative (-) bus and its shunt.

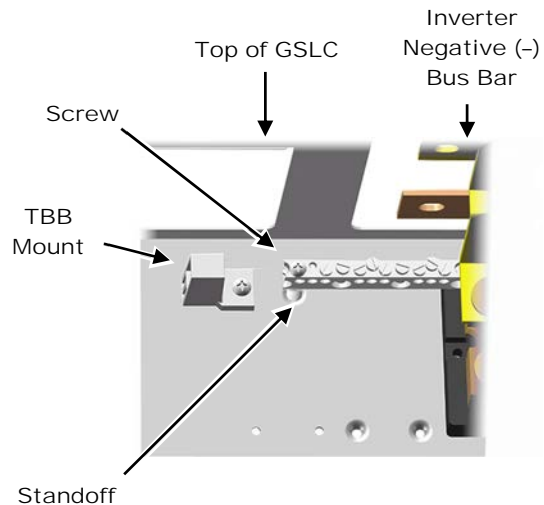

Negative-Ground Bond

To remove either of the bond connections:



1. Using a Phillips screwdriver, remove the screw shown above.
2. Remove the metal standoff beneath the bus bar. The screw and bus bar provide the mechanical bond to the chassis ground.
3. Rotate the TBB mount. Insert the bus bar into the open end of the TBB mount so that the TBB mount supports the bus bar. It may be necessary to loosen the TBB screw before rotating it.
4. Retighten the screw to secure the TBB mount.

NOTES:

- ❖ If the TBB is connected directly to the enclosure by a screw, then the bond is connected.
- ❖ If the TBB is held by the TBB mount and the TBB mount is secured to the enclosure, the bond is disconnected.
- ❖ The installed Neutral TBB has white insulators. A second Neutral TBB with blue insulators is included in the kit for locations where blue is standard.

Figure 27 Removing Bonding Connections

DC Wiring

	<p>WARNING: Shock Hazard</p> <p>Ensure all circuit breakers or disconnect devices are turned off or disconnected before connecting any wires.</p>
	<p>CAUTION: Fire Hazard</p> <p>Never install extra washers or hardware between the mounting surface and the battery cable lug. When installing multiple ring terminals or lugs, stack them on the mounting surface so that the largest conductor is in direct contact. Smaller ring terminals should be placed next in decreasing size order. Stacking the hardware in any other order can result in a loss of contact area for current flow. This may allow dangerous levels of heat to build up.</p>

Inverter Wiring

The DC disconnects are connected directly to the inverter using bus bars during the process of mounting. See page 29 for more information.

Battery Wiring

Consult the inverter *Installation Manual* for recommendations for cable number, sizing, and length. When using these recommendations, some models only require one set of battery cables while other models require two sets of cables. (A single set of larger conductors can be used if sized correctly.) See Table 1 on page 22 for required torque values.

Ensure DC disconnects are turned to the OFF position and all DC sources are disconnected (unbolt the battery end of the wires) before proceeding.

See the inverter's installation manual for additional information on battery wiring.

Battery Positive (+) Cable

Follow the instructions below when connecting battery positive (+) cables to these models:

- GSLC175-120/240 ○ GSLC175-PV-120/240 GSLC-PV-300VDC
- GSLC175-230 ○ GSLC175-PV-230 GSLC-PV-300VDC-230

Connect the positive (+) cables to the DC positive (+) wiring plate. This plate is located directly beneath the main inverter disconnects. It is intended for several ring lugs to be bolted to it.

- The smaller holes have a diameter of 0.31" (8 mm).
- The larger holes have a diameter of 0.4" (10 mm).

See item B in Figure 28 for hardware installation order on the positive (+) plate.

Follow the instructions below when connecting battery positive (+) cables to these models:

- GSLC175PV1-120/240 ○ GSLC-PV1-300VDC
- GSLC175PV1-230 ○ GSLC-PV1-300VDC-230

Connect the positive (+) cable directly to the DC disconnect, which uses an M8 stud. See item A in Figure 28 for an illustration of hardware installation order on the DC disconnect.

Follow the appropriate instructions when connecting to an "empty" GSLC which has been assembled with similar features to one of the models above.

Installation

Battery Negative (-) Cable

The battery negative (-) cables connect to the pre-installed shunt. This shunt is located to the upper left of the main inverter disconnect. It is designed for several ring lugs to be bolted to it, with openings of 3/8" (10 mm) diameter.

See item C in Figure 28 for an illustration of hardware installation order on the shunt. The shunt plate (GS-SBUS) may or may not be present.

NOTE: Do not install hardware in a different order from the illustrations in Figure 28. In all cases the battery cable lug must be the first item installed. It must make solid contact with the surface.

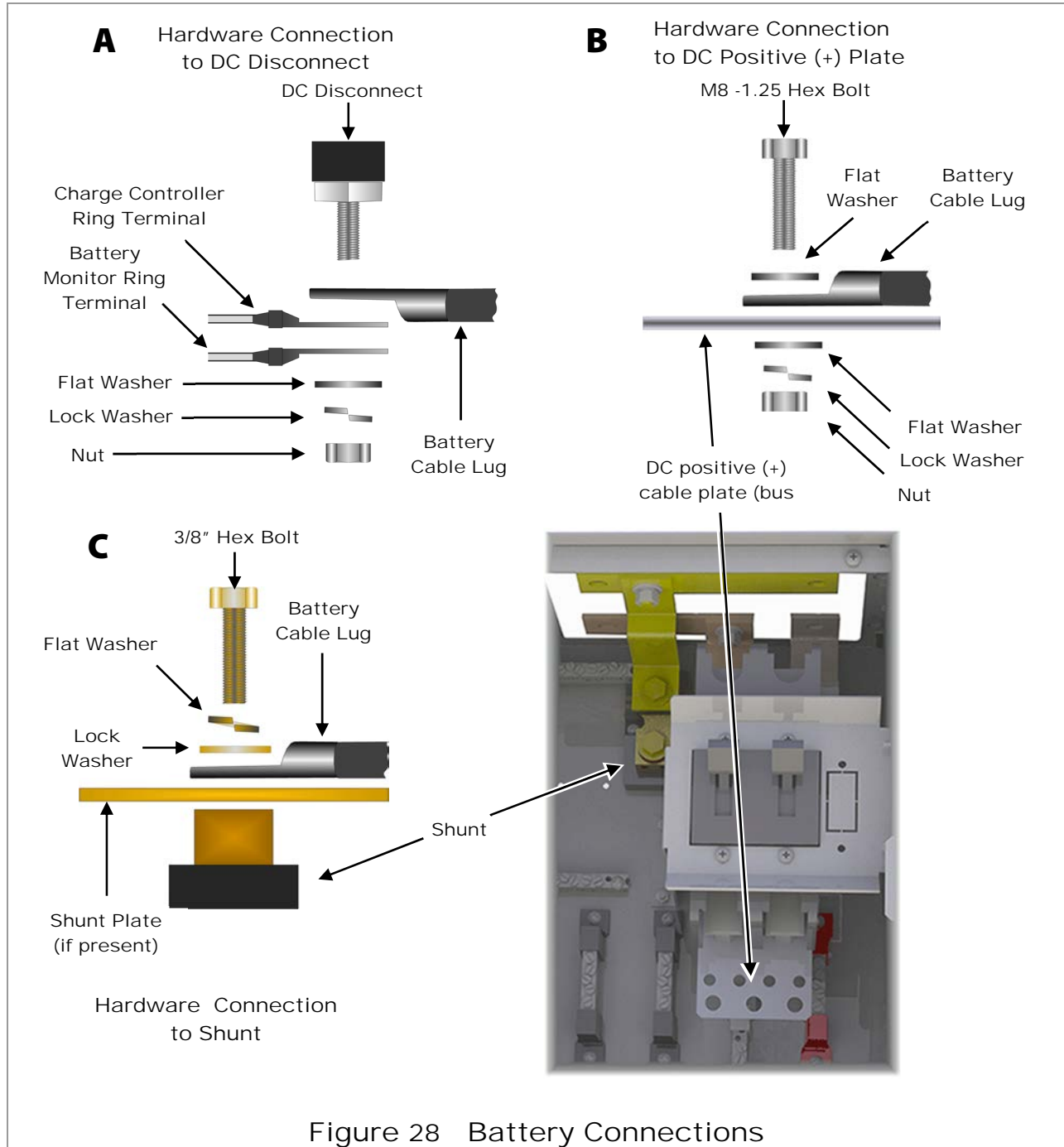

Installing the FLEXnet DC

The OutBack FLEXnet DC (FN-DC), or a similar battery monitor, may be added to the GSLC for observing DC current flow and providing battery state-of-charge information.

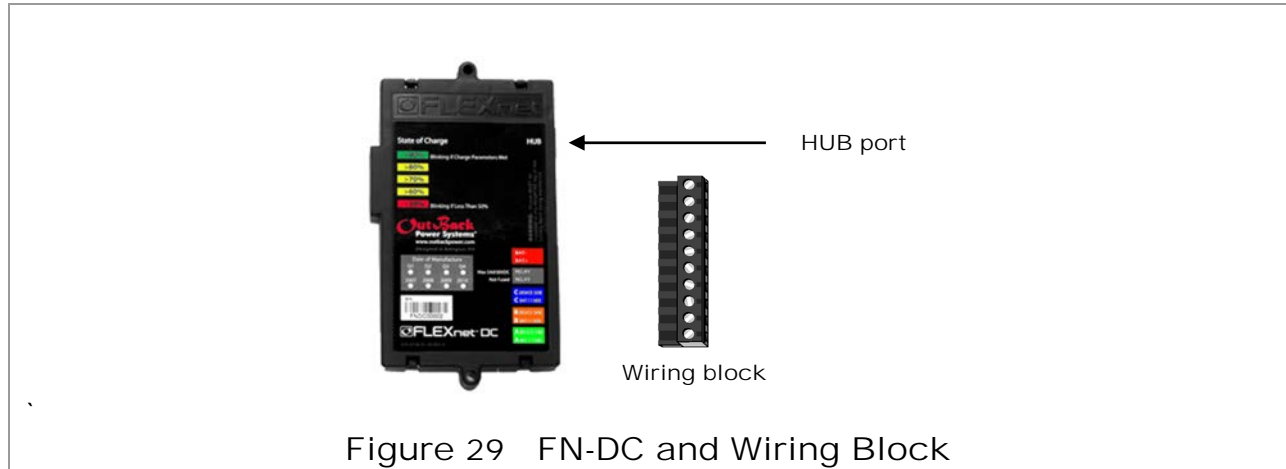
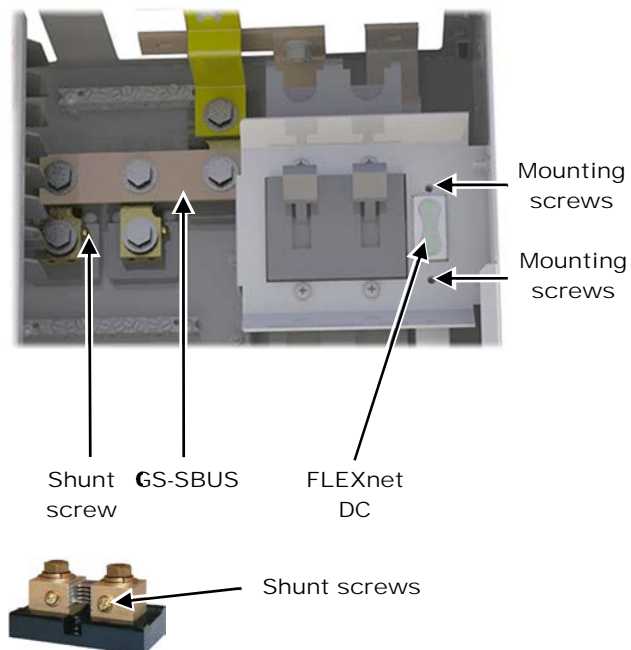

Figure 29 FN-DC and Wiring Block

To install the FN-DC:

1. Assemble the FN-DC wiring as shown in the manual for the FN-DC.
 - Attach sense wires to the FN-DC wiring block and plug it into the FN-DC.
 - Plug the CAT5 cable into the port labeled HUB.
2. Connect FN-DC wiring to the GSLC.
 - The positive (+) and negative (-) battery voltage sense conductors should connect directly to the battery bank.
 - The shunt sensing wires should connect to the screws on each shunt. It may be necessary to remove the GS-SBUS to reach the screws.
3. Mount the FN-DC by inserting it into the opening to the right of the inverter disconnects. It may be necessary to hold it in place.
4. Secure the FN-DC with mounting screws above and below. Tighten until secure, but do not over-tighten.



When connecting sensing wires: The end of the shunt connected to the GS-SBUS is the negative (-) battery connection and should be wired accordingly. The other end of the shunt is the “device” or “load” end and should be wired accordingly.

See the FLEXnet DC manual for more information on these connections. See Figure 48 on page 55 for an example of typical system wiring.

Figure 30 Installing the FLEXnet DC

DC Devices

In addition to inverter or PV connections, other devices may be connected to the GSLC, such as DC loads or sources. The wiring on these devices will vary with the application. In most cases the device will have a separate circuit breaker that is mounted on the rail as shown on page 27. It will be wired into the battery system using the existing bus bars or shunts. The number and location of these connections will vary with the options or accessories installed.

PV and Charge Controller Wiring

When wiring the FLEXmax, FLEXmax 100, or another charge controller to the GSLC, many elements are involved. These elements include the PV or RE source, the battery connections, the disconnect circuit breaker, the PV ground-fault device, and the charge controller.

These instructions are written for a PV source which uses the OutBack FLEXmax charge controller and the GFDI. Other applications will be similar.

NOTE: In GSLC models designated as “PV”, many of the connections below are already provided. The only connections necessary are those for external wiring to the charge controller.

To make PV and charge controller connections:

1. Connect the PV positive wire to the GSLC's PV positive (+) TBB (see Figure 31).
2. Connect the PV negative wire to the charge controller's PV negative (–) terminal (see Figure 32).
3. Install a wire from the PV TBB to the PV disconnect circuit breaker (see Figure 31).
4. Install a wire from the PV disconnect to the charge controller's PV positive (+) terminal.
5. Install a wire from the GSLC's DC positive (+) cable plate to one pole of the GFDI.
6. Install a wire from the GFDI to the charge controller's positive (+) battery terminal.
7. Install a wire from the charge controller's negative (–) battery terminal to the GSLC's negative TBB. If the FLEXnet DC or another battery monitor is in use, this wire should connect to the shunt which monitors that charge controller.
8. Repeat all steps for a second charge controller, if necessary.

NOTES:

- ❖ Each TBB accepts conductors from 1/0 AWG (70 mm²) to #14 AWG (2.5 mm²) in size. See Table 2 on page 33 for required torque values.
- ❖ For other GSLC required torque values (such as shunts and circuit breakers), see Table 1 on page 22.
- ❖ For torque values, wire sizes, and other information concerning the FLEXmax charge controller, see the *FLEXmax Series Charge Controllers Owner's Manual*.
- ❖ For more information on specific wiring of the GFDI, see the GFDI manual.
- ❖ Diagrams that display typical wiring for a PV system, including the FLEXnet DC, GFDI, and other elements of the system, are shown beginning on page 49.

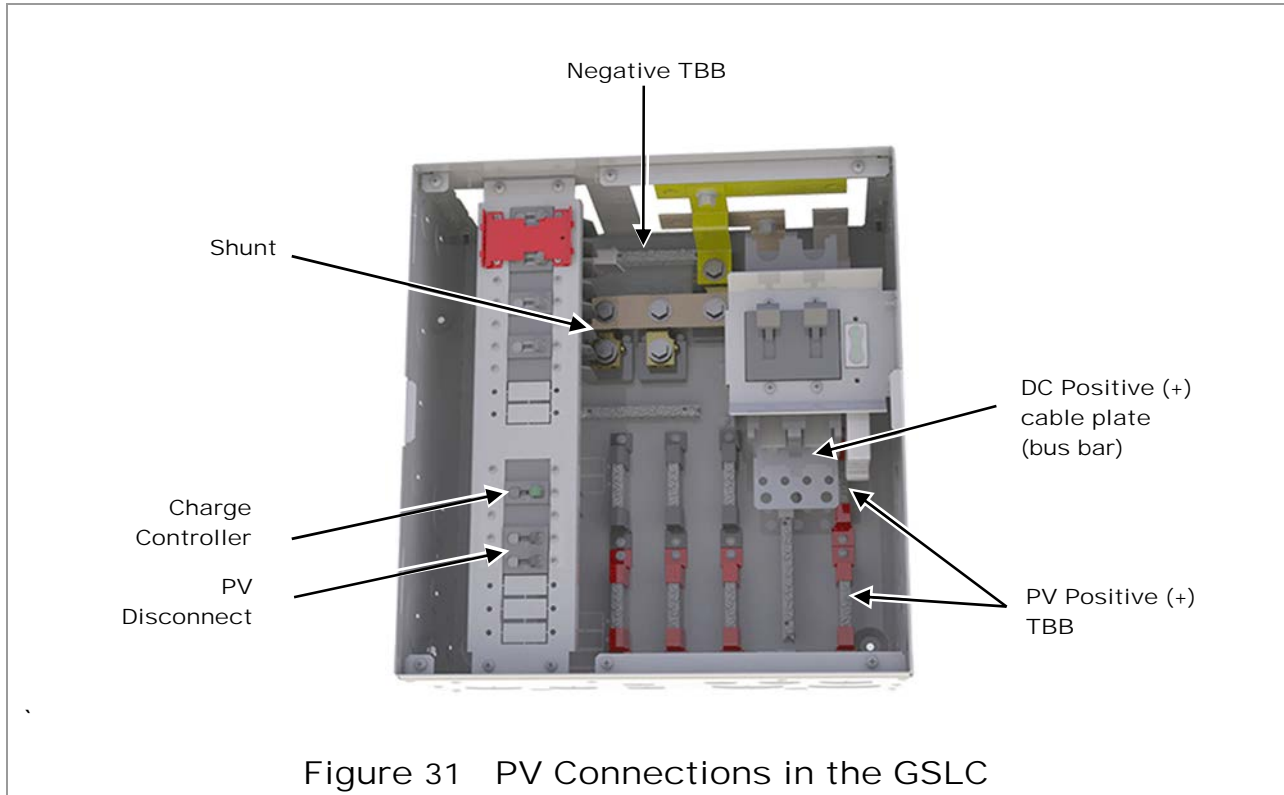

Figure 31 PV Connections in the GSLC

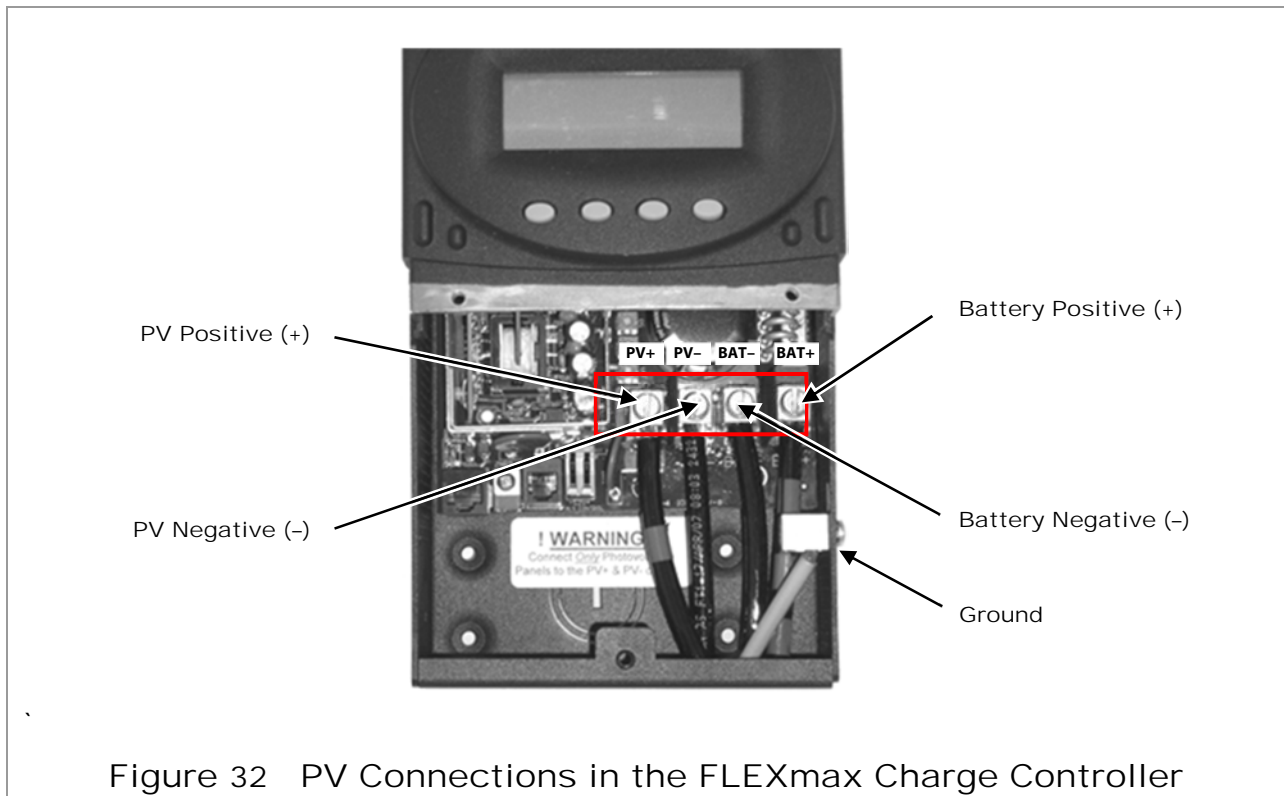

Figure 32 PV Connections in the FLEXmax Charge Controller

AC Wiring



WARNING: Shock Hazard

Ensure all circuit breakers or disconnect devices are turned off or disconnected before wiring. Make certain the inverter and other active devices are turned off or disabled before wiring.

Split-Phase Wiring

The GSLC can have multiple terminal bus bars for multiple AC connections. Because the Radian inverter possesses two sets of AC input connections and one set of output connections, up to three TBB sets are available. Each set of bus bars is paired in red and black, for the 120/240 Vac connections required by the Radian inverter.

The TBB set on the left is generally used for the inverter's AC output connections. The central TBB set is for utility grid connections and the right TBB set is for a generator. The preassembled GSLC models follow this convention.

Each TBB accepts conductors from 1/0 (70 mm²) to #14 AWG (2.5 mm²). See Table 2 on page 33 for required torque values.

If steps are inappropriate for a given system (such as instructions for a generator when none is present), they can be ignored.

To make the external AC connections to the split-phase GSLC:

1. Connect the L1 wire from the AC load panel to black TBB 1 (**Ac OUT - HOT L1**). Connect the L2 wire from the AC load panel to red TBB 2 (**Ac OUT - HOT L2**).
2. Connect the neutral wire from the AC load panel to neutral TBB 3.
3. Connect the L1 wire from the utility grid panel (if present) to black TBB 4 (**GRID IN - HOT L1**). Connect the L2 wire from the utility grid panel to red TBB 5 (**GRID IN - HOT L2**).
4. Connect the neutral wire from the utility grid panel (if present) to neutral TBB 3.
5. Connect the L1 wire from the generator (if present) to black TBB 6 (**GEN IN - HOT L1**). Connect the L2 wire from the generator to red TBB 7 (**GEN IN - HOT L2**).
6. Connect the neutral wire from the generator (if present) to neutral TBB 3.

NOTE: Remove the neutral-ground bond if necessary. See page 34.

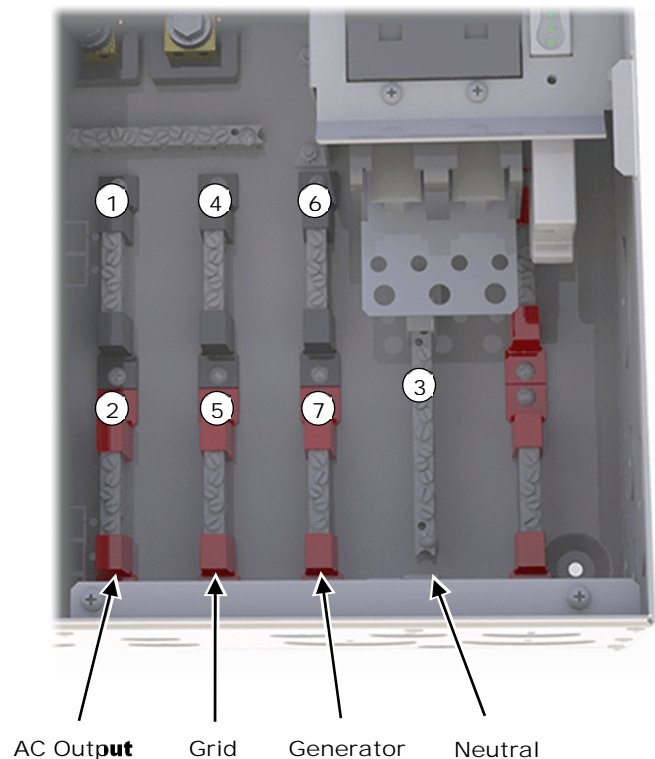

Figure 33 AC Terminal Bus Bars (split-phase)

Bypass Assembly

Bypass switching can be used when the inverter is shut down for maintenance. This topic is discussed more beginning on page 47. The GSLC can be equipped with the GS-IOB-120/240VAC bypass assembly. The instructions on this page are for making external connections to the bypass assembly after installation. (The installation wiring for the GS-IOB-120/240VAC is described on page 45.)

If no bypass assembly is used, connections should be made directly to each TBB from the circuit breakers for the inverter, AC sources, and loads. These connections are designated in Figure 33.

Wiring diagrams for an assembled 120/240 Vac system are shown beginning on page 49.

To make the connections to the Radian inverter:

1. Designate the top AC circuit breaker as the inverter AC output disconnect. Install a wire from the black AC output TBB (as shown in Figure 33) to the disconnect marked by 1.
2. Install a wire from the red AC output TBB to the disconnect marked by 2.
3. Install wires on the left side of the disconnect as marked by 3 and 4. Connect these wires to the appropriate L1 and L2 output terminals on the Radian inverter.
4. Designate the third AC circuit breaker from the top as the disconnect for one AC source (**GRID** or **GEN**). Install a wire from the black source circuit TBB (as shown in Figure 33) to the disconnect marked by 5.
5. Install a wire from the red source circuit TBB to the disconnect marked by 6.
6. Install wires on the right side of the disconnect as marked by 7 and 8. Connect these wires to the appropriate L1 and L2 input terminals on the Radian inverter (the terminals labeled either **GRID** or **GEN**).
7. If a second AC source is present, repeat steps 4 through 6 using the bottom circuit breaker.
8. Install a wire on the inverter's **NEU** terminal and connect it to the GSLC's neutral TBB (as shown in Figure 33). *Only one neutral connection is required.*

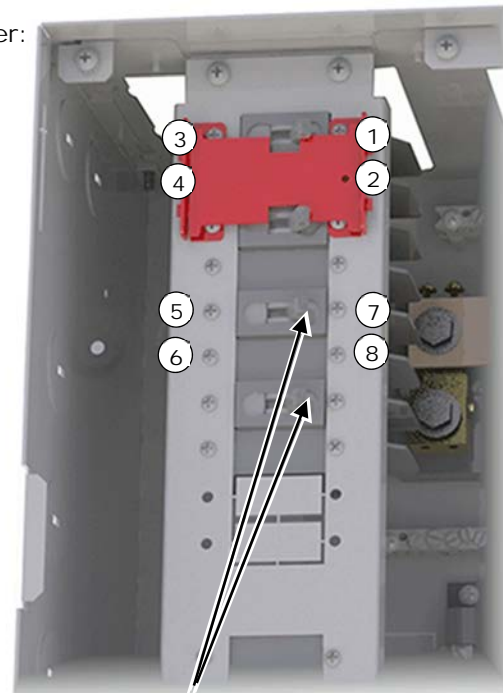

Disconnects

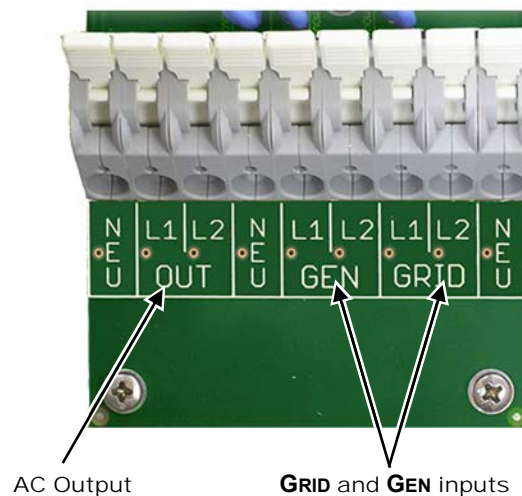

Figure 34 Inverter AC Connections (split-phase)

Single-Phase Wiring

The GSLC allows multiple terminal bus bars (TBB) for multiple AC connections. Because the Radian inverter possesses two sets of AC input connections and one set of output connections, three terminal bus bars are available for hot connections, as well as one neutral bus bar. The hot bus bars use brown insulators in 230 Vac models. The neutral bus bar uses blue insulators in 230 Vac models.

The TBB on the left is generally used for the inverter's AC output connections. The central TBB is for utility grid connections and the right TBB is for a generator. The preassembled GSLC models follow this convention.

Each TBB accepts conductors from 70 mm² (1/0 AWG) to 2.5 mm² (#14 AWG). See Table 2 on page 33 for required torque values.

If steps are inappropriate for a given system (such as instructions for a generator when none is present), they can be ignored.

To make external AC connections to the single-phase GSLC:

1. Connect the hot wire from the AC load panel to brown TBB 1 (AC Output).
2. Connect the neutral wire from the AC load panel to neutral TBB 2.
3. Connect the hot wire from the utility grid panel (if present) to brown TBB 3 (Grid).
4. Connect the neutral wire from the utility grid panel (if present) to neutral TBB 2.
5. Connect the hot wire from the generator (if present) to brown TBB 4 (Generator).
6. Connect the neutral wire from the generator (if present) to neutral TBB 2.

NOTE: Remove the neutral-ground bond if necessary. See page 34.

The neutral insulator in Figure 35 is in the position which opens the bond.

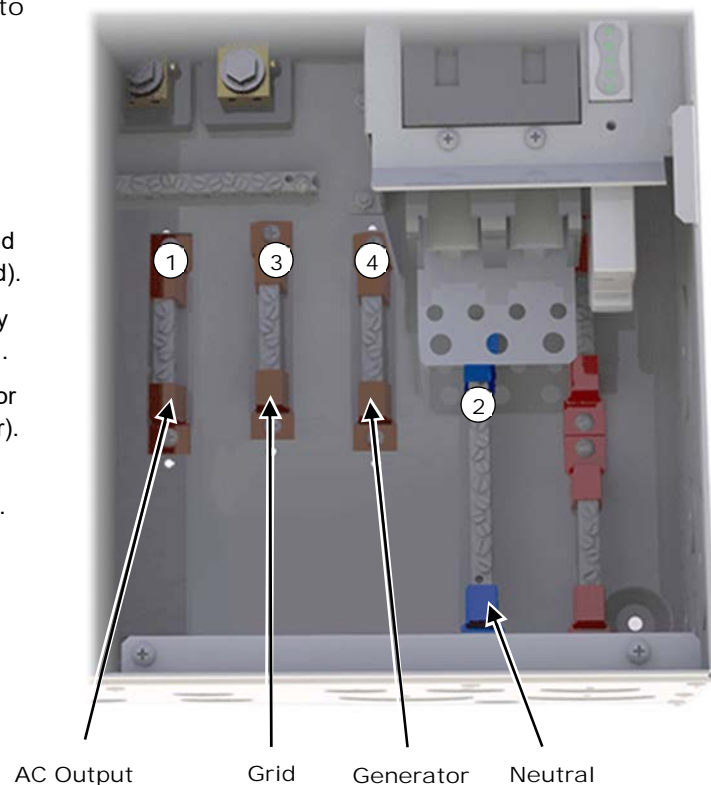

Figure 35 AC Terminal Bus Bars (single-phase)

Bypass Assembly

Bypass switching can be used when the inverter is shut down for maintenance. This topic is discussed more beginning on page 47. The GSLC can be equipped with the GS-IOB-230VAC bypass assembly. The instructions on this page are for making external connections to the bypass assembly after installation. (The installation wiring for the GS-IOB-230VAC is described on page 47.)

If the GSLC has no bypass assembly, connections should be made directly to each TBB from the circuit breakers for the inverter, AC sources, and loads. These connections are designated in Figure 35.

Wiring diagrams for an assembled 230 Vac system are shown beginning on page 54.

To make the connections to the Radian inverter:

1. Designate the topmost AC circuit breaker as the inverter AC output disconnect. Install a wire from the AC output circuit TBB (as shown in Figure 36) to that disconnect as marked by 1.
2. Install a wire on the left side of the disconnect as marked by 2. Connect the wire to the appropriate output terminals on the Radian inverter.
3. Designate the third AC circuit breaker as the disconnect for one AC source (**GRID** or **GEN**). Install a wire from the TBB of the appropriate source circuit (as shown in Figure 35) to the left side of that disconnect as marked by 3.
4. Install a wire on the right side of the source disconnect as marked by 4. Connect the wire to the appropriate input terminal on the Radian inverter (the terminal labeled either **GRID** or **GEN**).
5. If a second AC source is present, repeat steps 3 and 4.
6. Install a wire on the inverter's **NEU** terminal and connect it to the GSLC's neutral TBB (as shown in Figure 36). *Only one neutral connection is required.*

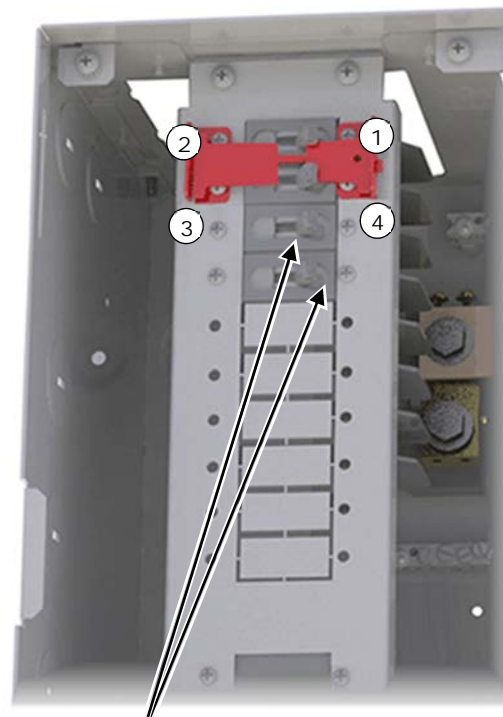

Disconnects

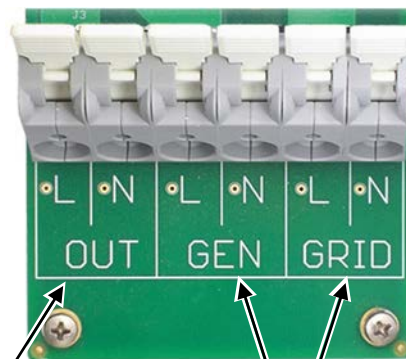

AC Output

GRID and **GEN** inputs

Figure 36 Inverter AC Connections (single-phase)

Wiring the AC Bypass Assembly

All models other than the “empty” GSLC are equipped with a maintenance bypass assembly. As needed, the GSLC can be equipped with a bypass assembly using the GS-IOB-120/240VAC or GS-IOB-230VAC accessory kit as appropriate. The accessory kit should be installed according to its own instructions. Once installed, it can be wired by following the steps shown in Figure 37 or Figure 38 .

The operation of the bypass assembly is discussed on page 47. A series of GSLC diagrams with the bypass wiring (as well as the rest of both the AC and DC systems) are shown beginning on page 49.

These drawings show the utility grid circuit connected to the bypass assembly. This is the method used during factory installation. However, either the grid or the generator circuit may be used. A prewired assembly may be changed. Remove the first source from the bypass assembly and then wire the second according to the instructions. Connect the first source directly to the terminals as shown in the drawings beginning on page 49.

NOTE: Only one AC source may be bypassed with this assembly, even if two sources are present.



WARNING: Shock Hazard or Equipment Damage

- ❖ Bypassing multiple sources will usually connect the sources to each other, which may damage one or both sources. It can otherwise result in power being routed to inappropriate places.
- ❖ The internal GSLC bypass assembly cannot be used if multiple inverters are in use. See page 47.

To wire the GS-IOB-120/240VAC after installation:

1. On the disconnect for the AC source that will be used during bypass, install a wire from the upper pole as shown by 1. Connect it to the upper pole of the inverter bypass switch as shown by 2.
2. From the same disconnect, install a wire on the lower pole as shown by 3. Connect it to the lower pole of the inverter bypass switch as shown by 4.
3. On the right side of the inverter bypass switch, install a wire on the lower pole as shown by 5. Connect it to the right side of the lower pole on the output switch 6. Install a second wire between the upper poles of each switch as shown by **7** and **8**.

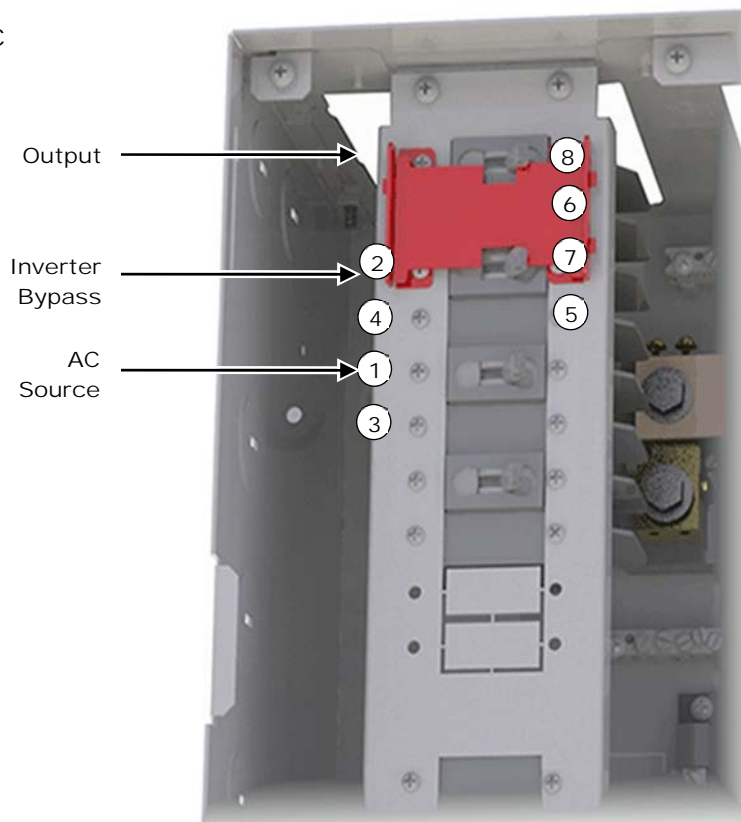

Figure 37 Maintenance Bypass Wiring (split-phase)

To wire the GS-IOB-230VAC after installation:

1. On the disconnect for the AC source that will be used during bypass, install a wire from the left side as shown by 1. Connect it to the input bypass switch as shown by 2.
2. Install a wire on the right side of the input bypass switch as shown by 3. Connect it to the right side of the output switch as shown by 4.

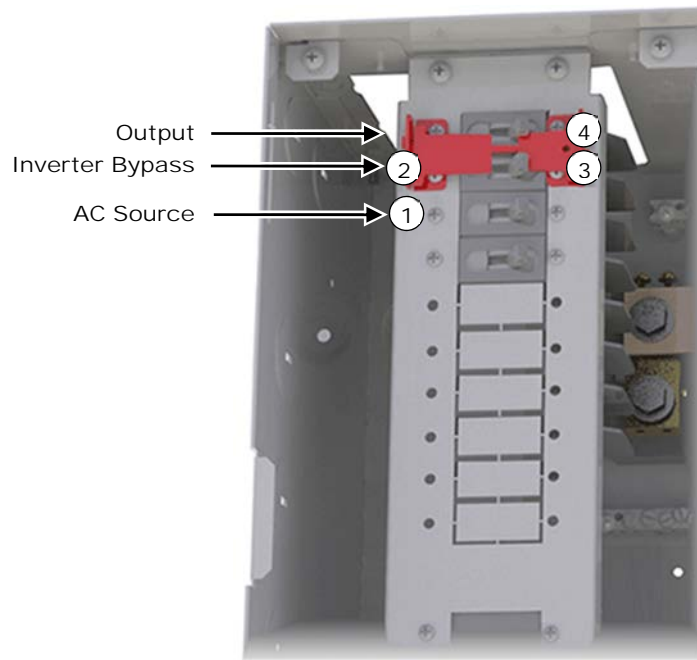

Figure 38 Maintenance Bypass Wiring (single-phase)

Multiple-Inverter Installations (Stacking Inverters)

When multiple Radian inverters are stacked for additional power, the basic wiring is repeated for each inverter. However, several factors need to be considered.

- One GSLC is required for each Radian inverter. A single GSLC cannot be sized to handle the requisite current for multiple Radian inverters.
- If more than two Radian inverters are installed, it is recommended to install a separate distribution panel to distribute incoming power to each GSLC individually. It may be advisable to install separate AC distribution panels to distribute input and output power to each GSLC.
- The GSLC maintenance bypass assemblies cannot be used when more than one Radian inverter is stacked. See the next section.

Bypass Switches

Inverter systems are often equipped with maintenance bypass switches or interlocks. If the inverter system ever needs to be shut down or removed, its AC sources and loads must be disconnected. A bypass device allows the AC source to “bypass” the inverter and deliver power directly to the loads. This can minimize disruption to the system and it avoids the need for extensive rewiring.

	<p>WARNING: Shock Hazard or Equipment Damage</p> <ul style="list-style-type: none"> ❖ Bypassing multiple sources will usually connect the sources to each other, which may damage one or both sources. It can otherwise result in power being routed to inappropriate places. ❖ The bypass assembly does not disconnect the inverter’s AC input. Even with the inverter bypassed, any AC input source may be a shock hazard unless disconnected.
---	---

In Figure 39, when Switch 1 is on (normal operation), the inverter’s output sends power to the loads. Switch 2 is off, preventing the inverter from sending power back to the AC source (backfeeding).

When Switch 2 is on (bypass operation), the AC source sends power directly to the loads. Switch 1 is off, removing the inverter’s output from the loads. This also prevents the AC source from backfeeding the inverter. With the inverter removed from the circuit, maintenance can be performed as necessary.

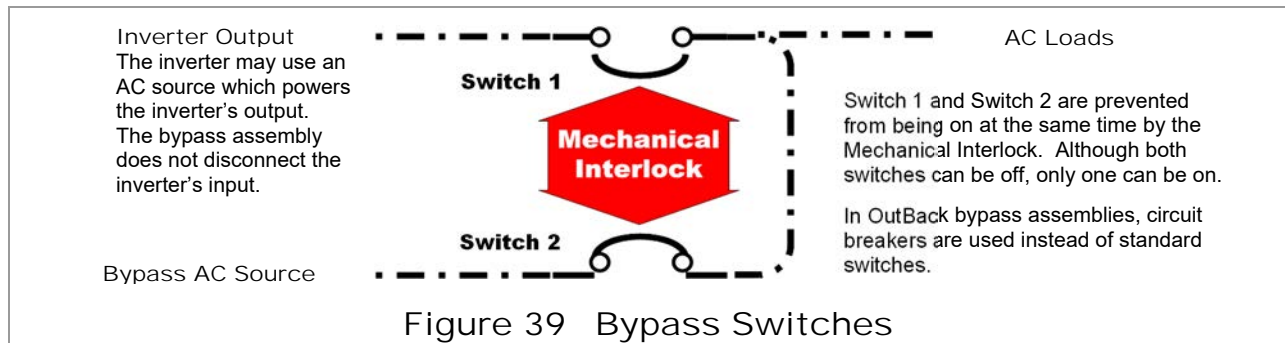

The GSLC can be ordered with bypass circuit breakers for this purpose, or it has a bypass option (the GS-IOB-120/240VAC or GS-IOB-230VAC) which can be installed.

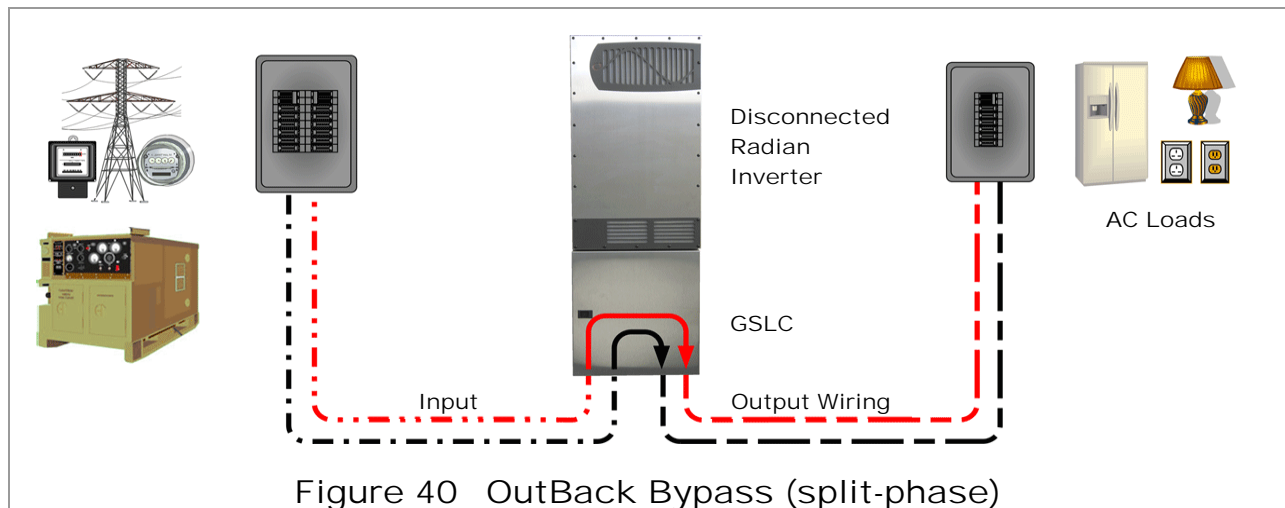

Installation



IMPORTANT:

If multiple Radian inverters are stacked in a single system, these devices cannot be used. The bypass function must be simultaneous for all inverters. The GSLC bypass kits operate independently, not simultaneously.

In a new system with multiple Radian inverters, the basic GSLC should be used in conjunction with an external assembly of this kind, as shown in Figure 41. The GS-IOB kits should not be installed, or if previously installed, should be removed and all wires disconnected.

OutBack does not offer a solution for bypassing multiple inverters. However, electrical suppliers offer both manual and automatic double-pole, double-throw bypass switches in a range of sizes and options. These are highly recommended for systems larger than a single inverter.



WARNING: Shock Hazard or Equipment Damage

Using independent bypass devices on multiple inverters can result in power being routed to inappropriate places. This could lead to an electric shock or to equipment damage.

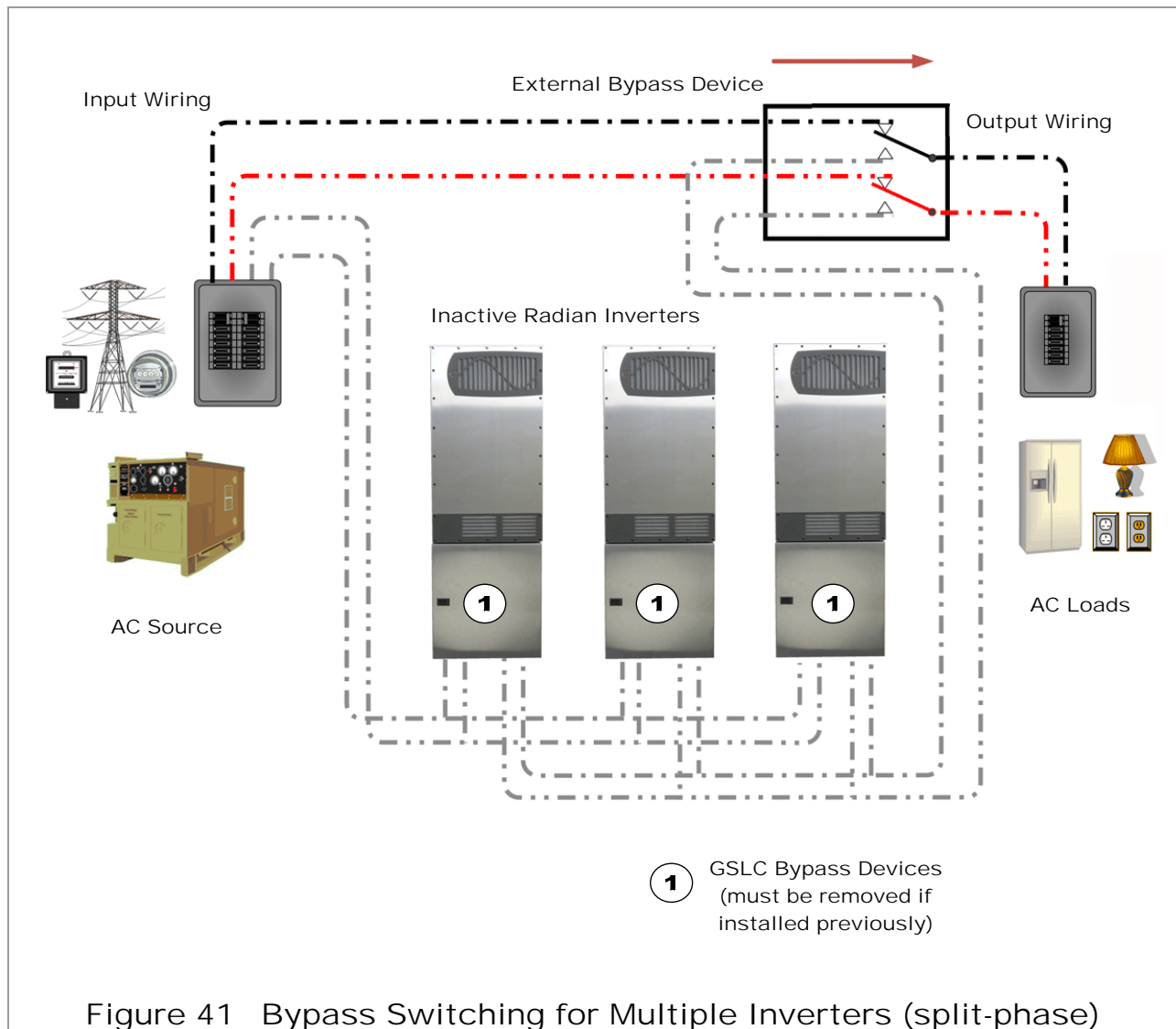

Wiring Diagrams

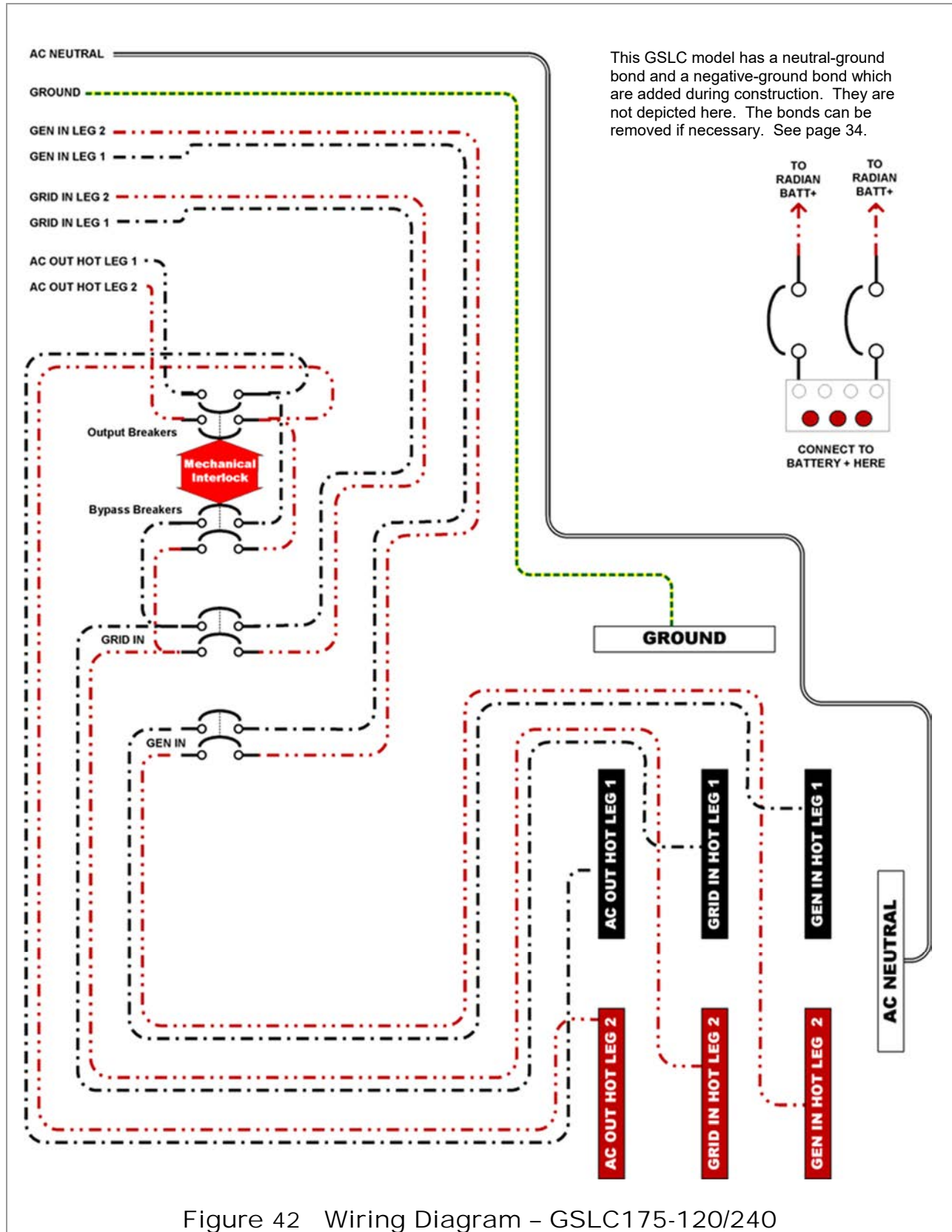

Figure 42 Wiring Diagram – GSLC175-120/240

Installation

This GSLC model has a neutral-ground bond which is added during construction. It is not depicted here. The bond can be removed if necessary. See page 34.

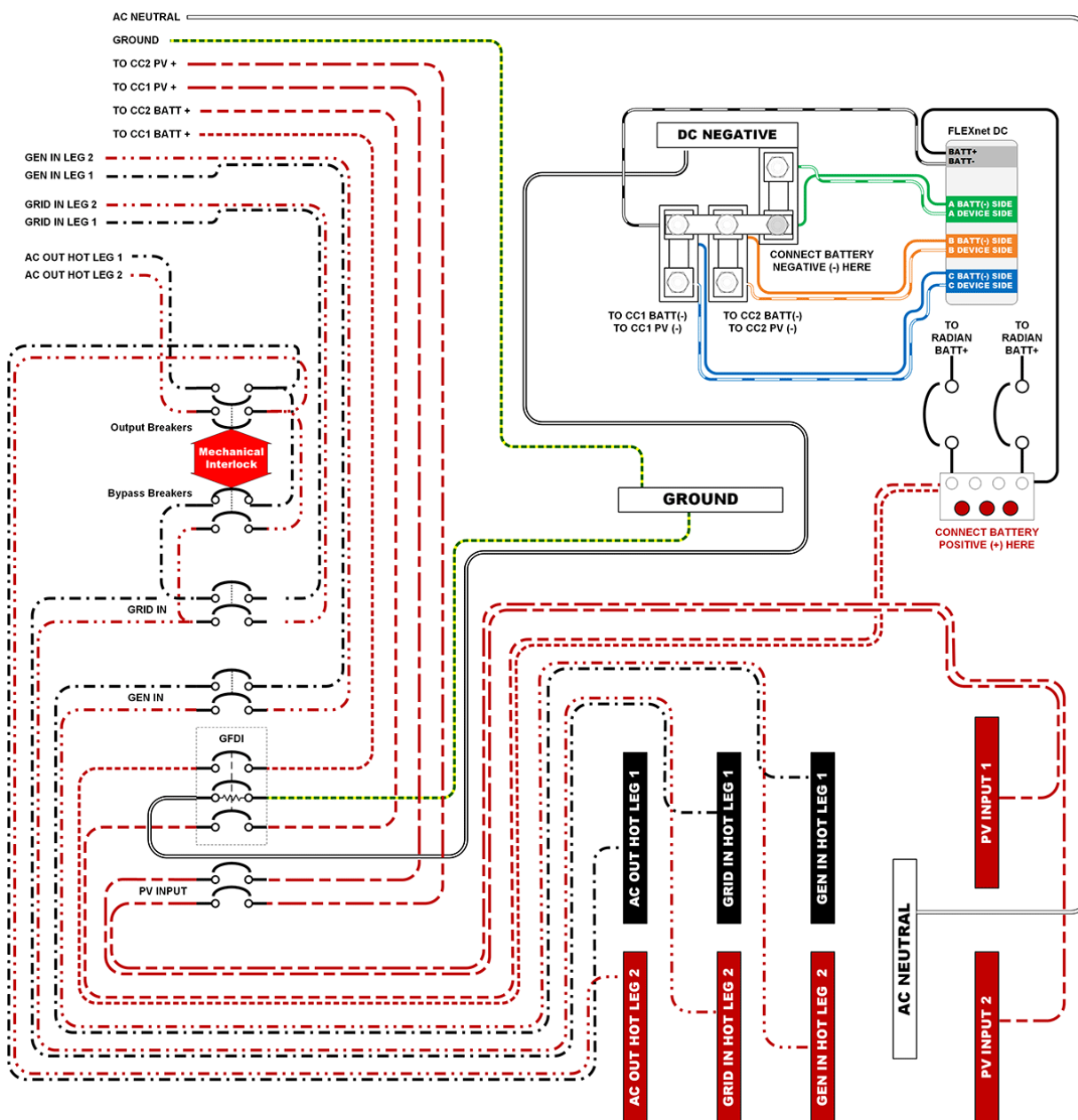

Figure 43 Wiring Diagram – GSLC175-PV-120/240 with FN-DC

This GSLC model has a neutral-ground bond which is added during construction. It is not depicted here. The bond can be removed if necessary. See page 34.

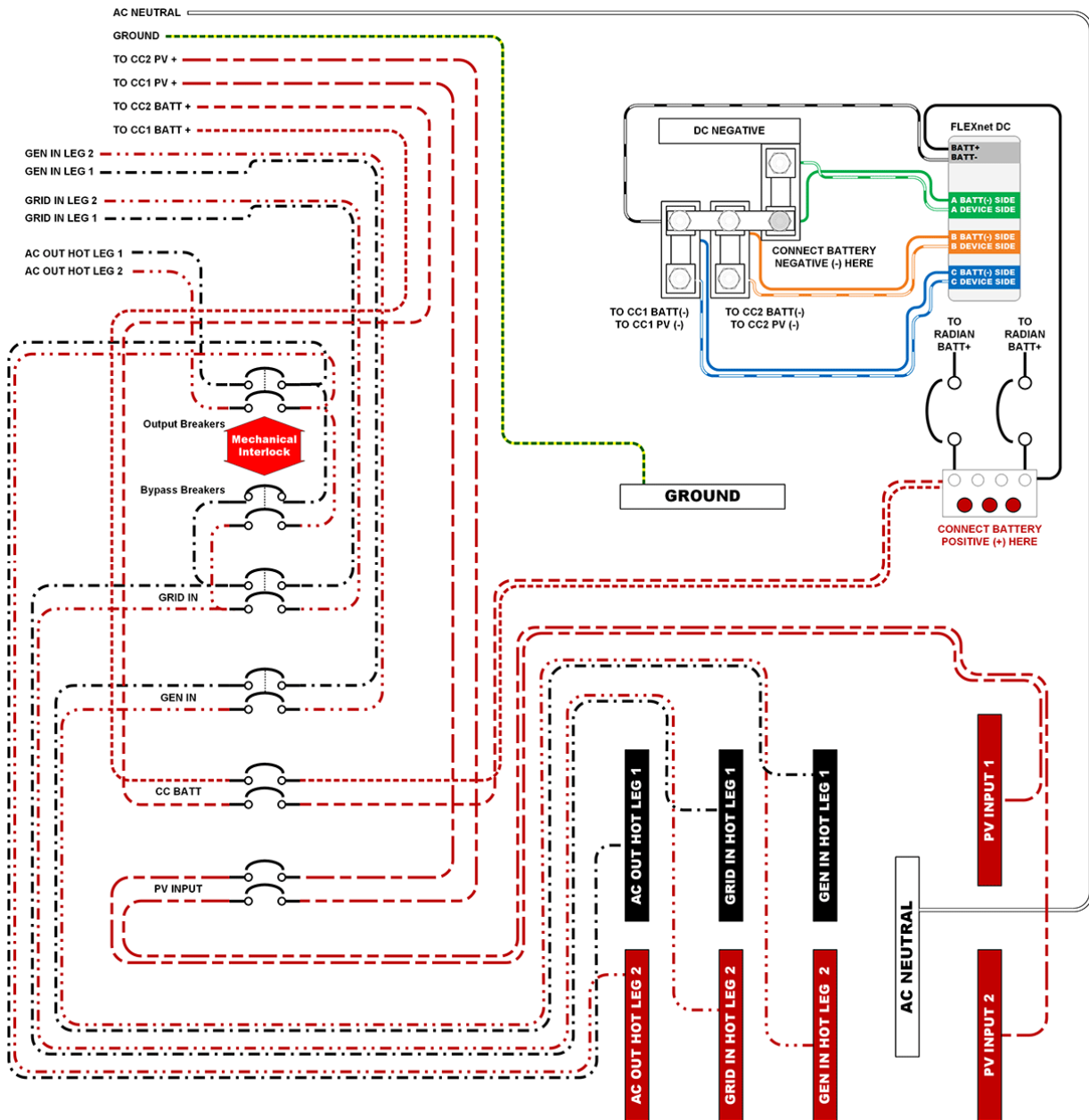

Figure 44 Wiring Diagram - GSLC-PV-300VDC with FN-DC

Installation

This GSLC model has a neutral-ground bond which is added during construction. It is not depicted here. The bond can be removed if necessary. See page 34.

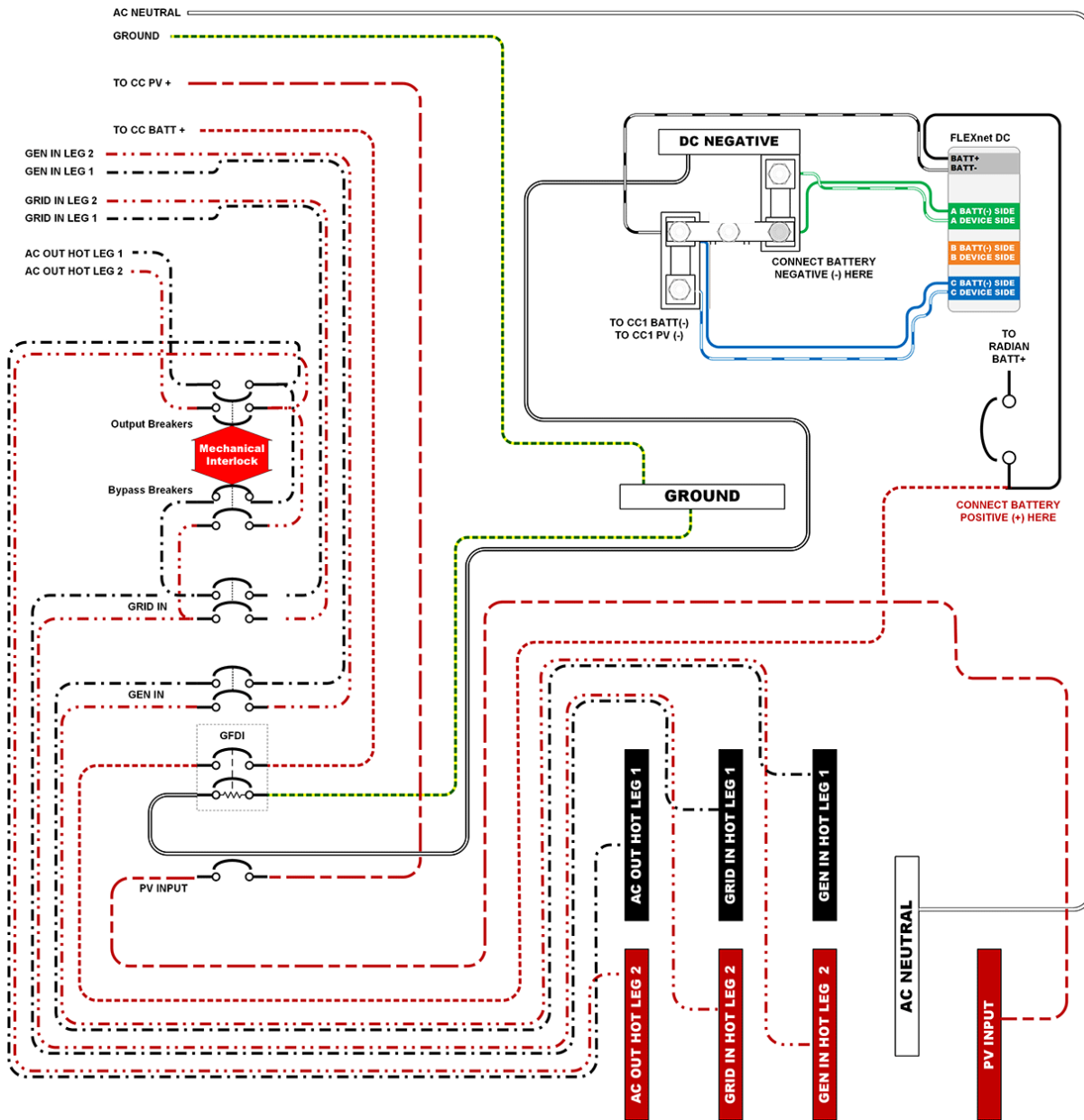

Figure 45 Wiring Diagram - GSLC175PV1-120/240 with FN-DC

This GSLC model has a neutral-ground bond which is added during construction. It is not depicted here. The bond can be removed if necessary. See page 34.

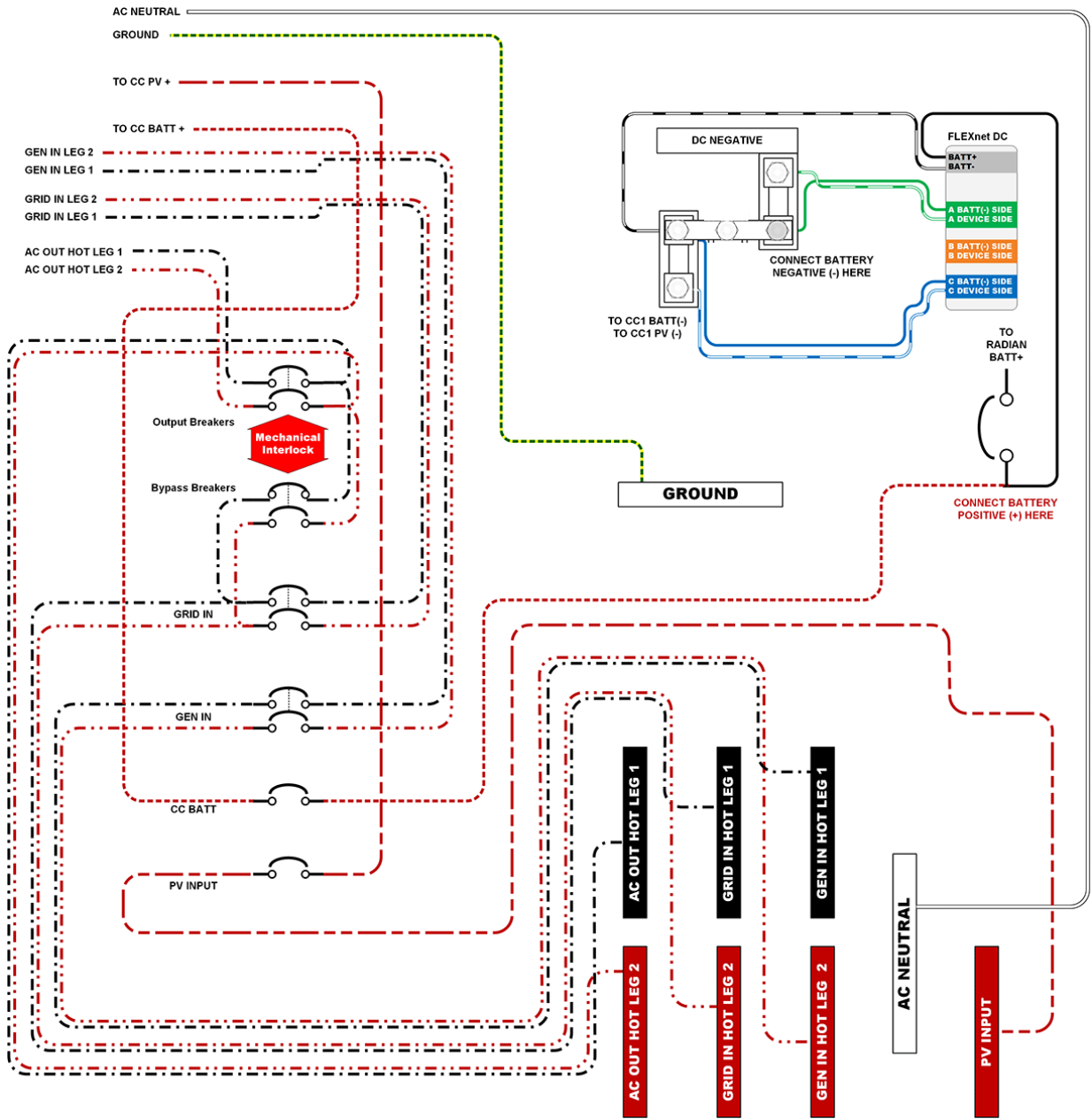

Figure 46 Wiring Diagram – GSLC-PV1-300VDC with FN-DC

Installation

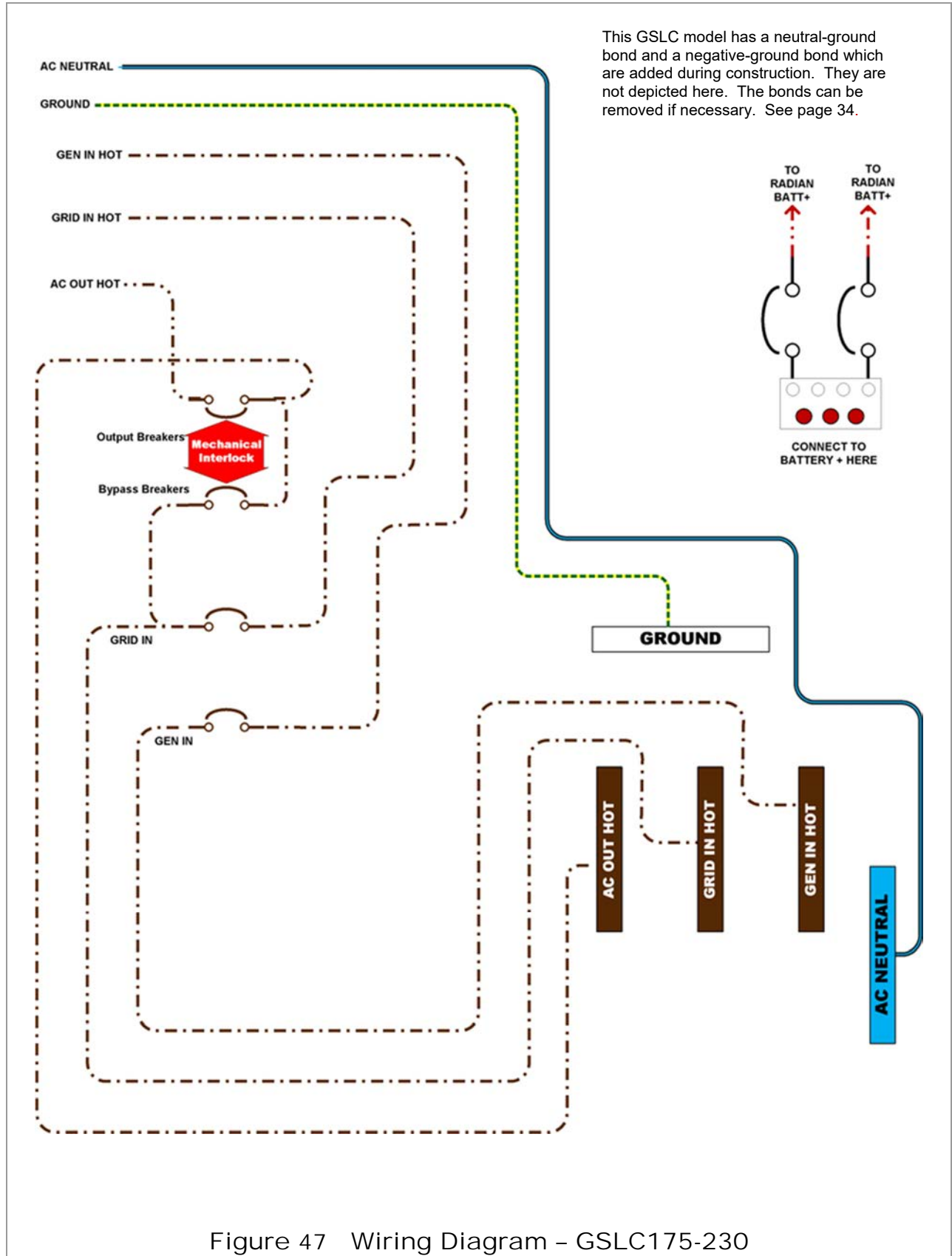

Figure 47 Wiring Diagram – GSLC175-230

This GSLC model has a neutral-ground bond which is added during construction. It is not depicted here. The bond can be removed if necessary. See page 34.

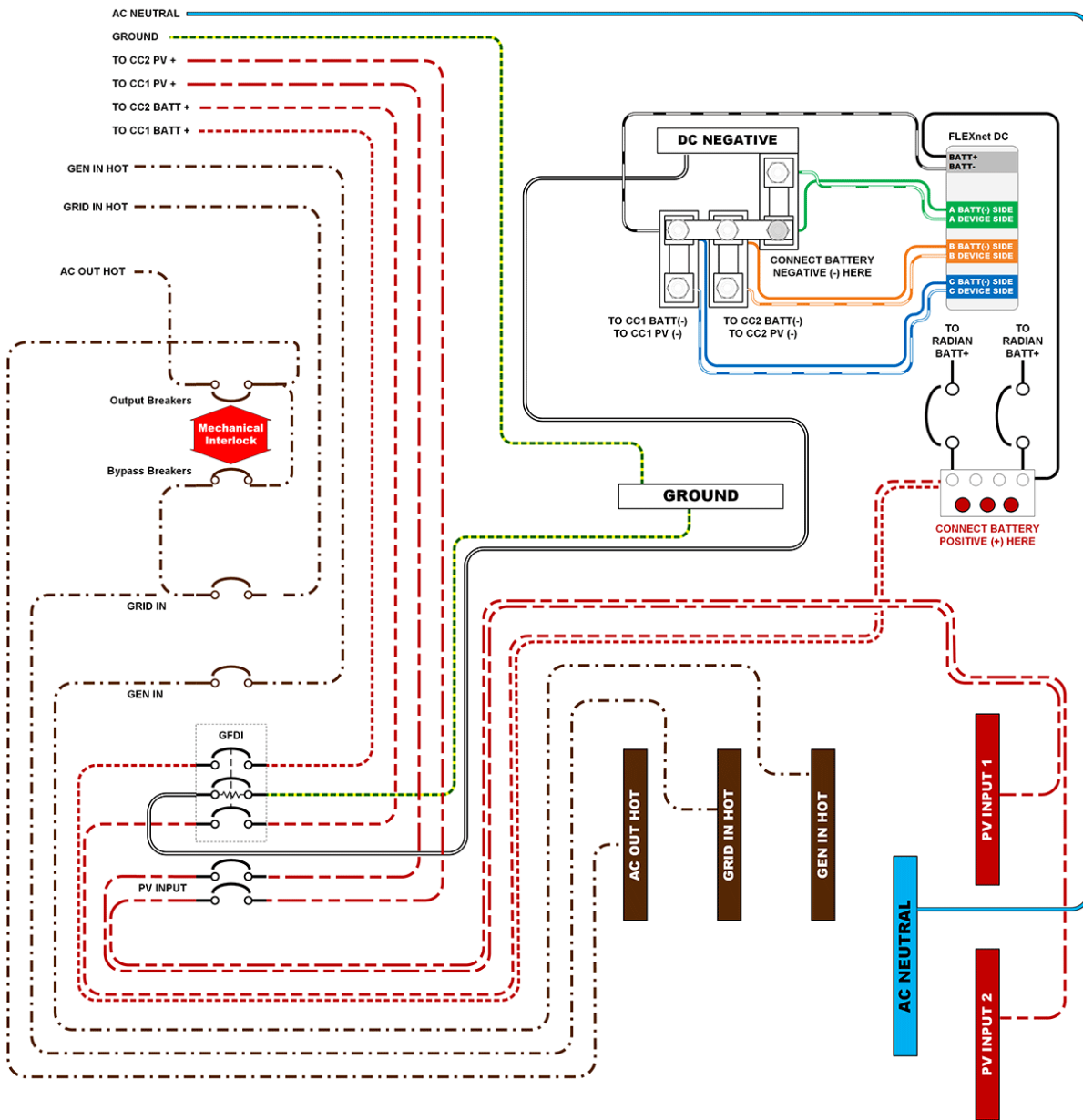

Figure 48 Wiring Diagram - GSLC175-PV-230 with FN-DC

Installation

This GSLC model has a neutral-ground bond which is added during construction. It is not depicted here. The bond can be removed if necessary. See page 34.

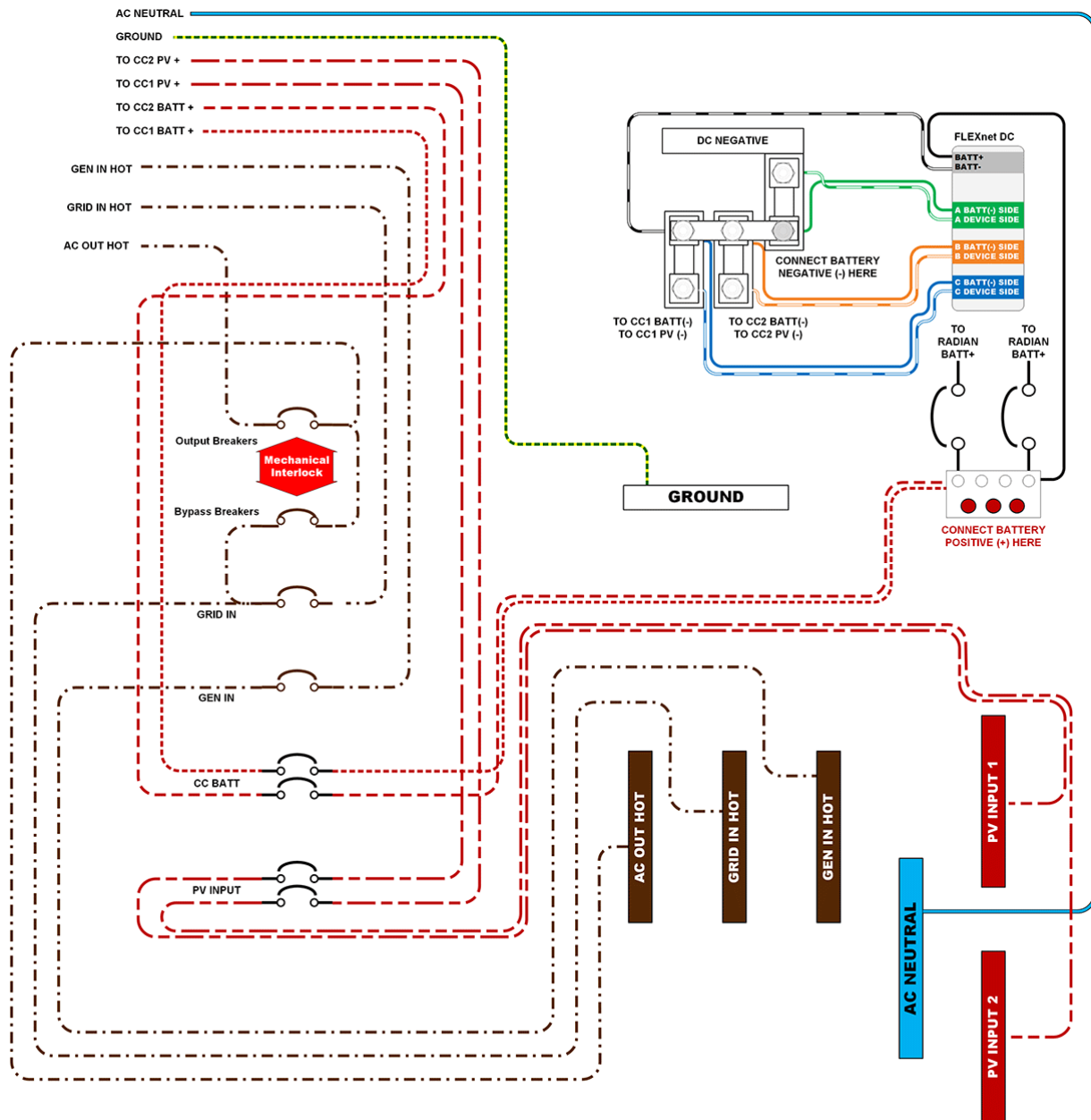

Figure 49 Wiring Diagram – GSLC-PV-300VDC-230 with FN-DC

This GSLC model has a neutral-ground bond which is added during construction. It is not depicted here. The bond can be removed if necessary. See page 34.

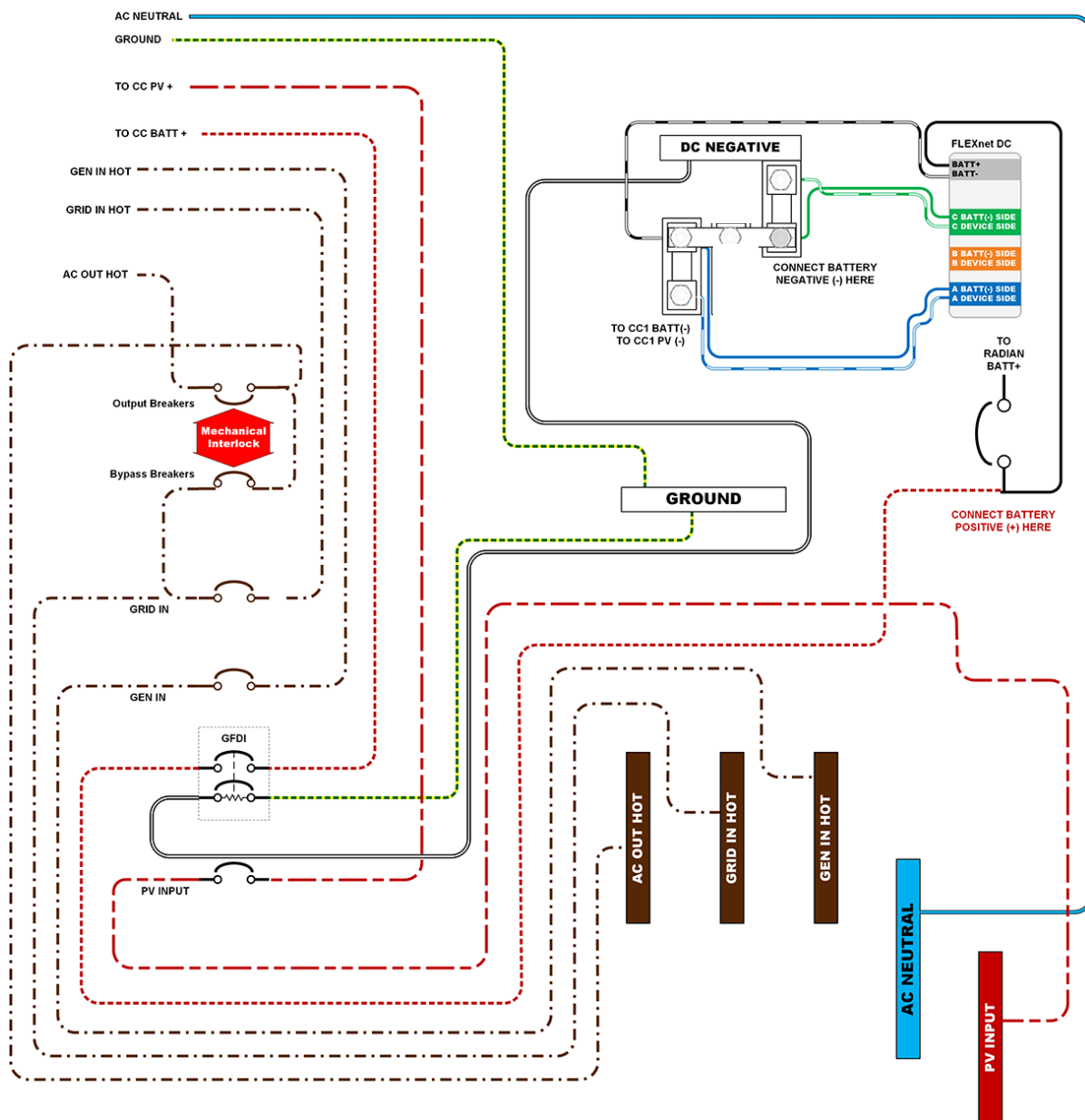

Figure 50 Wiring Diagram – GSLC175PV1-230 with FNDC

Installation

This GSLC model has a neutral-ground bond which is added during construction. It is not depicted here. The bond can be removed if necessary. See page 34.

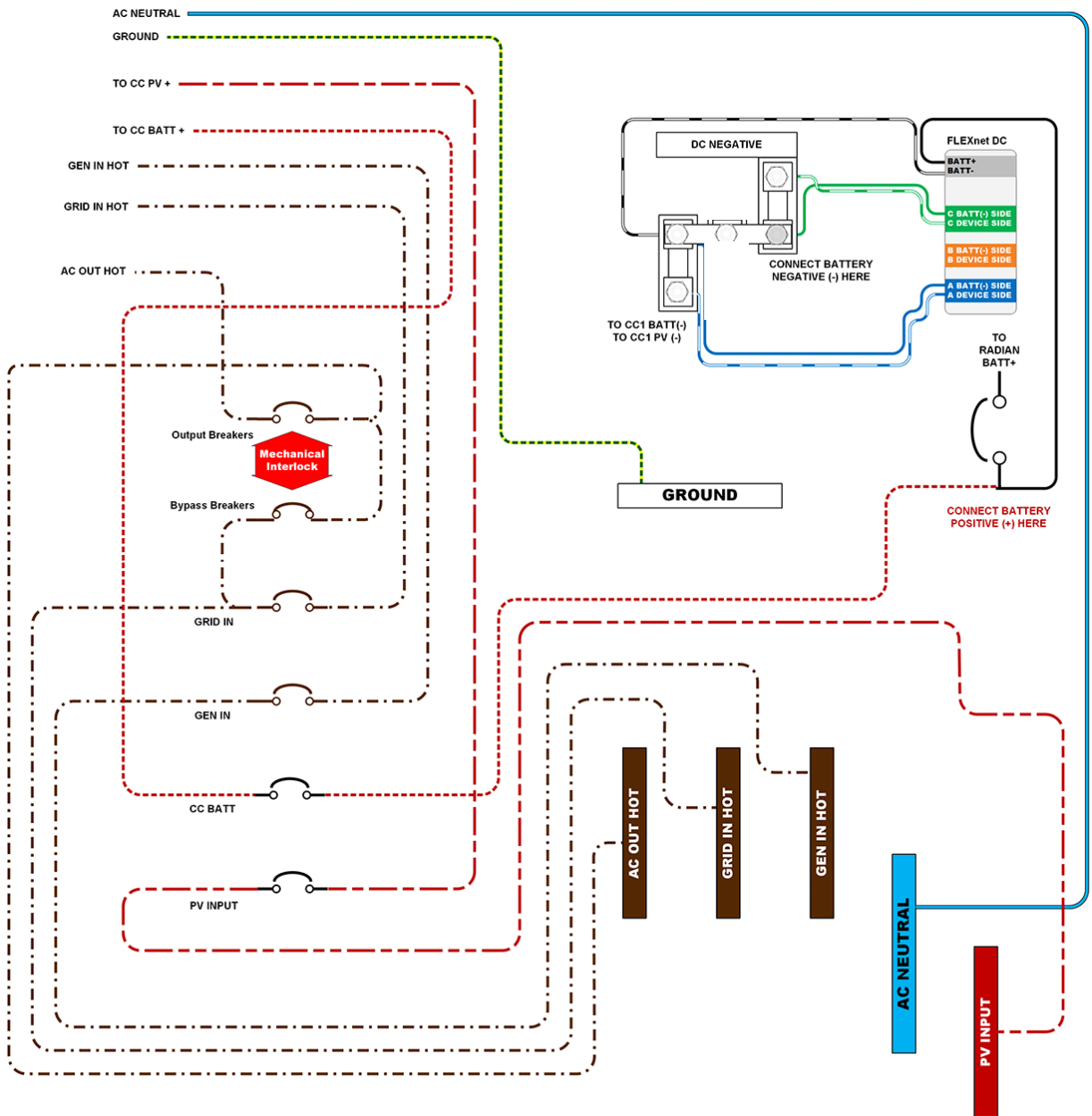

Figure 51 Wiring Diagram – GSLCPV1-300VDC-230 with FN-DC



Specifications

Electrical and Mechanical Specifications

Table 3 Specifications

Specification	Measurement
Maximum Voltages	240 Vac and 300 Vdc
Maximum Continuous Currents	40 Aac and 100 Adc
Operating Frequency Range	50/60 Hz or DC
Temperature Range	-20 to 50°C
Dimensions (H x W x D)	17 x 16 x 8.5" (43.2 x 40.6 x 21.6 cm)
Shipping Dimensions (L x W x H)	23.25 x 20.5 x 13.25" (59.1 x 52.1 x 33.7 cm)
Weight	26 lb (11.8 kg) minimum — varies with options
Shipping Weight	34 lb (15.4 kg) minimum — varies with options
Enclosure Type	Indoor

Regulatory Specifications

- UL 1741, Inverters, Converters, Controllers and Interconnection System Equipment for Use With Distributed Energy Resources (2nd Edition, Revised March 23, 2016)
- Canadian Electrical Code, Part II (CSA C22.2 No. 107.1-16 Ed.4)

Definitions

The following is a list of initials, terms, and definitions used in conjunction with this product.

Table 4 Terms and Definitions

Term	Definition
AC	Alternating Current; refers to voltage produced by the inverter, utility grid, or generator
CSA	Canadian Standards Association; establishes Canadian national standards and the Canadian Electrical Code, including C22.1 and C22.2
DC	Direct Current; refers to voltage produced by the batteries or renewable source
DVM	Digital Voltmeter
FN-DC	FLEXnet DC; OutBack battery monitor; used to measure battery state of charge
GFDI	Ground Fault Detector Interrupter; a safety device for PV systems
PV	Photovoltaic
RE	Renewable Energy
UL	Underwriters Laboratories; refers to a set of safety standards governing electrical products



Index

A

AC Bypass Assembly.....	42, 44, 45, 47
AC Circuit Breakers.....	27
AC Terminal Bus Bars.....	41, 43
AC Wiring	
120/240 Vac.....	41, 49, 50, 51, 52, 53
230 Vac.....	43, 54, 55, 56, 57, 58
Additional Components	19
Audience	6
AUX	60

B

Bonding	34
Brackets	18
Bus Bars	24
Bypass Switches	45, 47
Bypass Switching for Multiple Inverters	48

C

Caution Symbol.....	6
Charge Controller.....	9, 30, 38
Components	
Basic GSLC	10
GSLC175-120/240.....	11, 13
GSLC175-230.....	12, 14
GSLC175PV1-120/240	15
GSLC175PV1-230	16
Conduit Sizes	18
CSA	59

D

DC Devices	38
DC Disconnects	25
DC Positive Cable Plate (Bus Bar)	
Assembling	23
DC Shunts	26
DC Wiring	35
Dead Front	21
Definitions.....	60
Dimensions	17
DVM	60

E

Environmental Requirements	17
----------------------------------	----

F

Features and Functions	7
FLEXmax Charge Controller.....	9, 30, 38
FLEXnet DC.....	37
Front Door.....	21
FW-CCB and FW-CCB2	18, 30

G

GFDI	27, 34
Grounding	33

H

HUB Communications Manager	9, 31
----------------------------------	-------

I

Important Symbol.....	6
Interior Cover	21
Internal Hardware	22
Inverter Main Disconnects	25
Inverter Positive Bus Bars	24

K

Keyhole Mount.....	28, 29
Knockouts	18

M

Materials Required.....	17
Model Descriptions	7, 19
Mounting	
Charge Controller	30
GSLC	28
HUB	9, 31
Inverter	28
Mounting Holes.....	18

Index

N

Negative-Ground Bonding.....	34
Neutral-Ground Bonding	34
Note Symbol.....	6

O

Optional Hardware	19
-------------------------	----

P

Positive Bus Hardware.....	23, 24
PV Circuit Breakers.....	27
PV Wiring	38

R

Regulatory	59
------------------	----

S

Safety	6
Specifications	
Electrical	59
Mechanical.....	59
Regulatory.....	59

Stacking Inverters	46
Symbols Used.....	6

T

Terms and Definitions	60
Tools Required.....	17
Top Cover	20
Torque Values.....	22

U

UL	59
----------	----

W

Warning Symbol.....	6
Wire Size and Torque Requirements.....	33
Wiring	
120/240 Vac	41, 49, 50, 51, 52, 53
230 Vac	43, 54, 55, 56, 57, 58
Bonding	34
Charge Controller	38
DC.....	35
FLEXnet DC	37
Grounding.....	33
PV	38

This page intentionally left blank.



Masters of the Off-Grid.™ First Choice for the New Grid.

Corporate Headquarters
17825 – 59th Avenue N.E.
Suite B
Arlington, WA 98223 USA
+1.360.435.6030

European Office
Hansastraße 8
D-91126
Schwabach, Germany
+49.9122.79889.0