

Installation and operating Instructions

Contents

Introduction	2
Planning	3
Field of application	3
Technical data	4
Electrical configuration	5
Assembly	6
Safety and transport	6
Installation site	6
Module orientation	6
Shading	6
Racking	6
Clamp system	7
Installation types	8
Electrical connection	11
Safety	11
Installation	11
Grounding	11
Maintenance and cleaning	12
Troubleshooting	12
Disassembly/Recycling	13

Introduction

Congratulations on purchasing your high-efficiency solar module from Meyer Burger Industries (MBI). Meyer Burger solar modules generate energy in a very sustainable and environmentally friendly way because energy generated in solar cells does not produce any greenhouse gases. MBI wants the manufacture of photovoltaic modules to be sustainable as well.

This is why MBI focused from the outset on high-quality materials, resource-efficient production processes, utmost recyclability within the closed circle economy, reliable and transparent supply chains, as well as optimized transportation routes, for example by rail. MBI's solar modules let you transform the sun's power into electrical energy in an environmentally friendly way, directly and without limitations, for several decades. Please read these instructions carefully and follow them to ensure that you get the most out of your MBI solar modules. Not following the instructions could lead to personal injury and property damage. These installation instructions describe how to install the MBI solar modules safely.

General information

- Before installing the solar system, consult the applicable directives and licensing requirements from the competent local authorities and utility companies. You can only be sure of economic success once you have taken these requirements into consideration.

- Please follow all the necessary applicable safety instructions during setup and installation. The installer who sets up the system bears the responsibility.
- Keep the assembly instructions for the entire service life of the solar modules.
- Make sure that these assembly instructions are accessible to the operator at any time.
- Pass on these assembly instructions to any future owner or user of the solar panels.
- Pay attention to any other applicable documents.
- Remove the adhesive tape on the back that protects the cables and connectors before assembly.
- For more information, see our website:
www.meyerburger.com

Proper use

This manual is valid in Africa, Asia, Europe, Latin America as well as North and South America. The instructions provide information about safety when handling MBI's crystalline, high-performance solar modules and about their installation, assembly, wiring, maintenance and recycling.

NOTE

The module warranty will be voided if the installation instructions are not followed or there are changes made to the module.

Planning

Field of application

The modules are suitable for the following fields of application:

- Operating temperature -40°C to $+45^{\circ}\text{C}$.
- Module operating temperature -40°C to $+85^{\circ}\text{C}$.
- Max. push loads of 6,000 Pa and max. pull loads of 4,000 Pa (test loads)*.
- Assembly is on a racking for solar modules.

- The modules are tested and approved in accordance with IEC 61215-2016, IEC 61730-2016, UL61730-1 and UL61730-2.
- All country-specific electrical and construction safety standards must be strictly observed during installation.
- Do not point concentrated light onto the modules.

*depending on mounting type and configuration. Design loads shall be calculated from test loads with an additional safety factor of 1.5 (see chapter "Installation types").

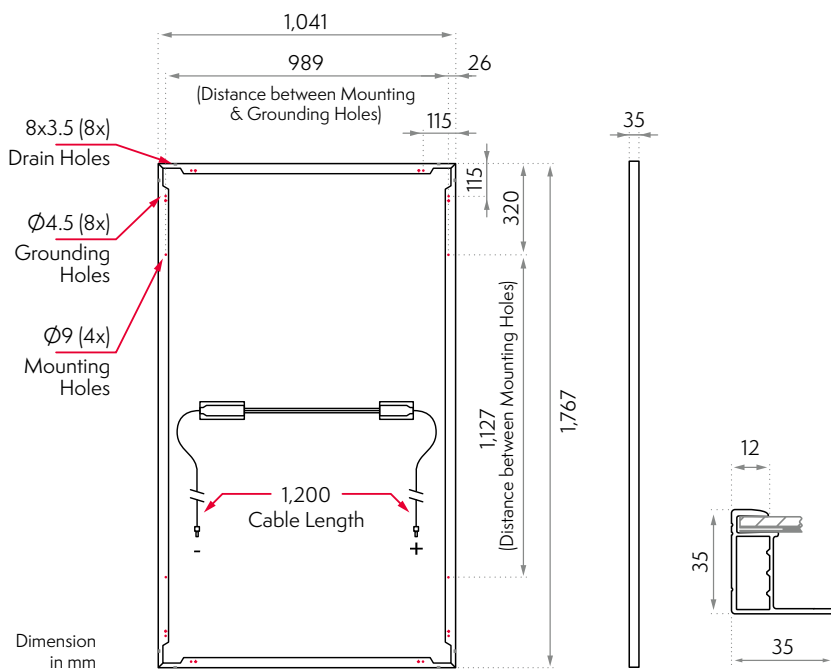
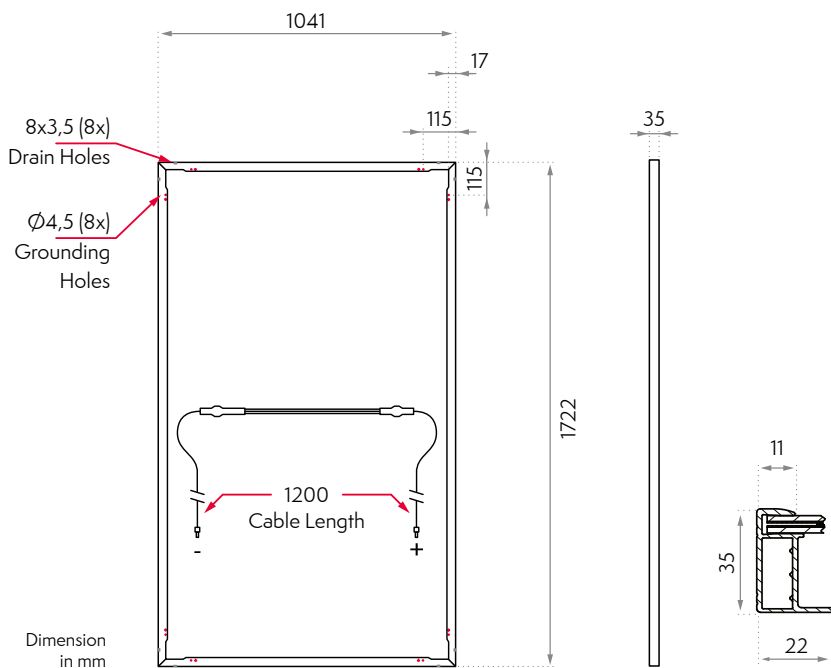

Top: Meyer Burger Glass, Bottom: Meyer Burger Black and Meyer Burger White – Dimensions

Technical data

For technical data, please refer the module data sheets for Meyer Burger Black, White or Glass, version Q1_2023_V5_UL_en.
For more detailed information about the corresponding modules, please visit: <https://www.meyerburger.com>

Module Line	Meyer Burger Black	Meyer Burger White	Meyer Burger Glass
Solar cell type	120 half-cells, mono n-Si, HJT with SWCT™ cell technology	120 half-cells, mono n-Si, HJT with SWCT™ cell technology	120 half-cells, mono n-Si, HJT with SWCT™ bifacial cell technology
Front glass	Tempered solar glass, 3.2 mm, with anti-reflective surface	Tempered solar glass, 3.2 mm, with anti-reflective surface	Tempered solar glass, 2.0 mm, with anti-reflective surface
Rear cover	Black water-barrier backsheet	White water-barrier backsheet	Solar glass, 2.0 mm
Dimensions H x W x D [mm]	1,767 x 1,041 x 35	1,767 x 1,041 x 35	1,722 x 1,041 x 35
Area [m²]	1.84	1.84	1.79
Weight [kg]	19.7	19.7	24.4
Max. design load +/- (incl. a safety factor of 1.5) [Pa]	4,000/2,666	4,000/2,666	4,000/2,666
Safety factor	1.5	1.5	1.5
Max. test load +/- [Pa]	6,000/4,000	6,000/4,000	6,000/4,000
Permissible module temperature [°C]	-40 – +85	-40 – +85	-40 – +85
Permissible ambient temperature [°C]	-40 – +45	-40 – +45	-40 – +45
Maximum system voltage [V]	1,000	1,000	1,500
Maximum reverse current [A]	20	20	25
Junction box protection class	3 diodes, IP68 rated in accordance with IEC 62790	3 diodes, IP68 rated in accordance with IEC 62790	3 diodes, IP68 rated in accordance with IEC 62790
Cable	PV cable 4 mm², 1.2 m long, in accordance with EN 50618	PV cable 4 mm², 1.2 m long, in accordance with EN 50618	PV cable 4 mm², 1.2 m long, in accordance with EN 50618
Connector	1: MC4; 2: MC4-Evo2; 3: UKT Energy PV-CO02; 4: TE Connectivity PV4-S1 In accordance with IEC 62852, IP68 rated only when connected	1: MC4; 2: MC4-Evo2; 3: UKT Energy PV-CO02; 4: TE Connectivity PV4-S1 In accordance with IEC 62852, IP68 rated only when connected	1: n.a.; 2: MC4-Evo2; 3: UKT Energy PV-CO02; 4: TE Connectivity PV4-S1 In accordance with IEC 62852, IP68 rated only when connected
Fire performance class (according to UL 61730)	Type 2	Type 1	Type 29
Safety class	II	II	II

Electrical configuration

- The key electrical data for the MBI modules is provided in the product data sheets at: <https://www.meyerburger.com/>.
- Meyer Burger modules have three pre-installed bypass diodes (non-exchangeable) that guarantee protection and improved performance in case of shade.
- Only modules from the same line and performance class can be interconnected.
- Under normal conditions, all Meyer Burger solar modules are likely to produce higher current and/or voltage than reported at standard test conditions. A safety factor of at least 1.25 for the electrical values (V_{oc} , I_{sc}) shall be used for determining component voltage ratings, conductor current ratings, and size of controls connected to the PV output.
- Meyer Burger Glass modules are bifacial solar modules with a bifaciality factor as specified in the module data sheet (www.meyerburger.com). Dependent from the specific conditions of the installation site (e.g. reflectivity of the ground or roof surface) Meyer Burger Glass modules additionally collect energy from the received rear irradiation. Therefore all components of the electrical system must be correctly dimensioned by a qualified person in accordance with the relevant regulations and site-specific conditions.
- We recommend using UV-resistant PV cables. They must have a cross-section of at least 4 mm² (12 AWG) and be heat-resistant at least up to 90°C (194°F).
- Choose identical connectors (same manufacturer, same connector family) for extension and connection cables and for module to module connection. Meyer Burger modules use different connector types. Those types are marked with a number on the module labels. The identification of the numbers can be found on the data sheet and in the installation manual on page 4.
- Avoid shade to achieve optimal solar irradiation and thus maximize yield.
- The individual system components (modules, fuses, inverters...) must be matched according to their data sheets.
- Observe the local, regional and national regulations on the installation of electrical systems.

Series connection

- The modules can be connected in series for the desired total voltage.
- The current (I_{mpp}) of modules connected in series should be the same because the maximum current is determined by the module with the lowest current.

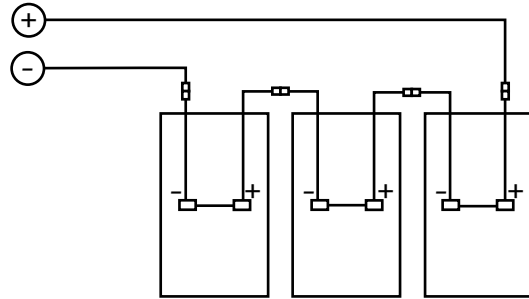

Series connection

- The maximum system voltage must be observed and can be found in the table in the “Technical Data” chapter under “Maximum system voltage” or the data sheet for the corresponding module.

Parallel connection

- The modules can be connected in parallel for the desired total current.
- The voltage (V_{mpp}) of the modules connected in parallel should be the same.
- Install overcurrent protection devices (OCPD) in accordance with the relevant standards and national codes. Please follow the guidelines in Article 690-8 and 690-9 of the NEC accordingly.
- Additional reverse-current protection (e.g. blocking diodes or fuses) must be installed in each module string if the possible reverse current exceeds the overcurrent protection rating of the modules.

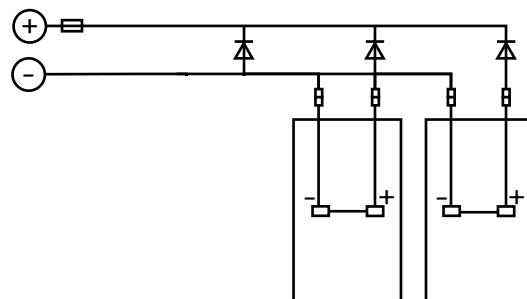

Parallel connection

- The overcurrent protection rating can be found in the module data sheet. The string fuse rating shall not exceed the overcurrent protection rating of the module.
- The cable cross-section of the extension cable must be matched to the maximum current of the connection.

Series-parallel connection

- The modules can also be connected in combination.
- All components must be matched and the individual connection instructions for series and parallel connection taken into consideration.
- Connect the same number of modules in a series string (same string voltage).
- Additional safety precautions are needed to protect the cables and modules from overcurrent.

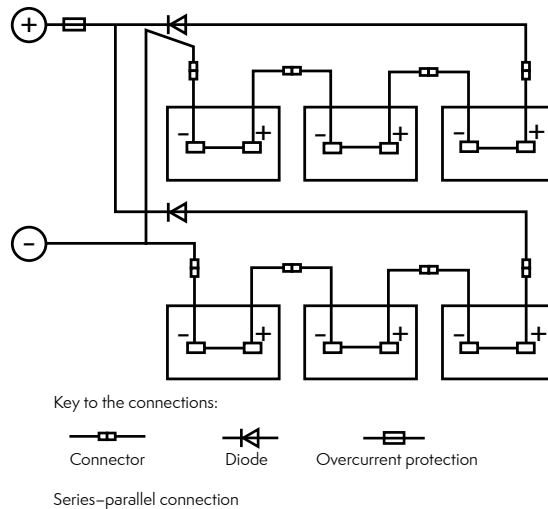

Installation

Safety and transport

Handling the modules

- When handling the modules, always wear clean gloves and hold them by the module frame.
- When unpacking the modules, the front side must be protected against scratches, etc.
- Do not short-circuit (couple) the solar module cables under any circumstances.
- Do not move or carry the modules by grabbing the cables.
- Do not step on the modules.
- Do not place heavy objects on the modules (e.g. tools or tool boxes).

Installation site

Follow the instructions below for the installation site:

- The modules must not be installed:
 - in closed spaces.
 - over 2,000 m above sea level*.
 - on water surfaces*.
 - in places where water may accumulate (e.g. due to floods).
 - near easily flammable gases or vapors (e.g. gas tanks or gas stations).
 - at sites where contact between chemical substances (e.g. oil and solvent) and parts of the module is possible.
 - in the direct proximity of ventilation and air conditioning systems.
- The modules must not be used as a substitute for roofing or facades.
- If installing less than 500 m from the sea, special precautions regarding grounding, maintenance, and cleaning are necessary.

Module orientation

- The modules can be installed in portrait or landscape direction.
- Make sure that there is no backwater. Rain and melted snow and ice water must be able to drain freely.
- Do not cover or seal off the water drains in the module frame.
- The minimal tilt angle is 5°.
- Observe the local regulations for the maximum tilt angle.
- A tilt angle of more than 20° has a positive impact on the module's self-cleaning capacity.

Shading

Optimal solar irradiation leads to a maximum energy yield:

- Install the modules facing the sun.
- Avoid shade and partial shade (e.g. from trees, chimneys, buildings, dirt, snow, power lines, etc.).
- Avoid harsh shading on the back of the Meyer Burger Glass modules through racking system parts and unnatural high irradiations through concentrated reflections of the surroundings.

Racking

Racking requirements:

- The racking must meet the necessary structural requirements in accordance with the local snow and wind loads.
- Meyer Burger solar modules can be mounted in combination with UL 2730 certified mounting systems if listed.
- Uneven snow loads (e.g. snow cornice, snow drifts) that lead to much higher local loads must be eliminated or prevented through technical measures.
- In addition to the wind and snow loads, no other forces must impact the module through the racking.
- The racking must be mounted on the roof or ground properly.

*Assembly at altitudes of over 2,000 meters above sea level or on water surfaces can be planned in consultation with the manufacturer.

- The forces acting on the module must be transferred to the racking.
- There may be no objects (air outlets, aerials, etc.) on the rear of the module that produce pressure concentrations during module deflection.
- The racking must ensure adequate cooling through rear ventilation of the module.
- The mount should be free of tension to enable changes in length due to temperature.
- Additional tensions and torques at the assembly points are not permitted.
- Make sure that the clamps or slide-in profiles, etc. do not touch the glass, even in loading conditions.
- Make sure that there is a distance of at least 50 mm under the junction box to the racking and other hard structures.
- Make sure that the cables cannot become jammed between the laminate and the mounting rails under a high pressure load. We recommend laying the cable along the module frame.
- Avoid contact between different metallic materials (contact corrosion; refer to the electrochemical series).
- Use corrosion-resistant screws and washers for mounting.
- The fastening screws and washers should have the same material properties.

Clamp system

Use clamps which meet the following requirements:

- Clamp width: 40 mm.
- Clamp height for 35 mm module height.
- Clamp depth: 9 mm.
- The clamps must not touch the front glass.
- No cells must be shaded as a result of the clamps.
- The clamps must not damage or deform the module frame.
- The clamps must meet the necessary structural requirements at the installation site.
- The clamps must be fastened firmly in the assembly system.
- Use clamps which guarantee long-term stability and secure attachment of the modules to the racking.
- The clamps must be installed in accordance with the manufacturer's instructions, including any specific hardware and torque requirements. A tightening torque of 15 Nm (133 lbs-in) need to be used.
- Use M8 screw, stainless steel

Detailed description of tested mounting clamp.

Manufacturer	Mounting Systems (Clamp option 1)	K2 Systems (Clamp option 2)
Type end clamp	MEC FH 35mm steel	Universal OneEnd
Type mid clamp	No mid clamp was used	Universal OneMid
Tightening torque	15 Nm / 133 inch Pounds	15 Nm / 133 inch Pounds
Width of clamp	40 mm	65 mm
Depth of clamp	9 mm (over module frame)	7 mm (over module frame)
Height of clamp	37.8 mm (designed for 35 mm module frame)	30-42 mm
Clamp min thickness	2.5 mm	

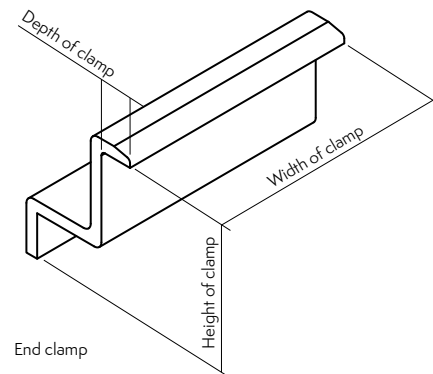

End clamp

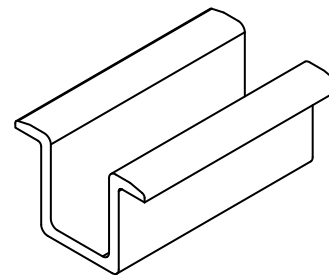

Mid clamp

Installation types

Module			Installation type			Design load		Test load	
White	Black	Glass	Name	Clamp type	Distance to module edge [mm]	Push [Pa]	Pull [Pa]	Push [Pa]	Pull [Pa]
x	x	x	CP1	1,2	200-450	4000	2666	6000	4000
				1,2	320	3600	1600	5400	2400
				2	0-200	1600	1600	2400	2400
				2	450-550	3200	1600	4800	2400
x	x	x	CP2	2	0-300	1600	1600	2400	2400
x	x	x	CL1	2	200-450	3600	1600	5400	2400
				1,2	320	3600	2666	5400	4000
				2	0-200	1600	1600	2400	2400
				2	450-550	1600	1600	2400	2400
x	x	x	CL2	2	0-300	1600	1600	2400	2400
x	x	x	IP1		complete frame rails needs to be covered	3600	2666	5400	2400
x	x	x	IP2			1600	1600	2400	2400
x	x		MP1	2	320	3600	2666	5400	4000
x	x		MP2	2	320	1600	1600	2400	2400

Legend:

CP: Clamp point

CL: Clamp line

MP: Mounting point

IP: Installation profile

Installation with clamps

Point mounting

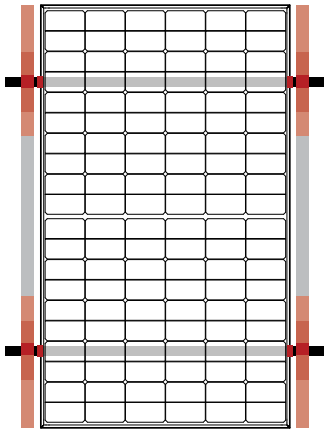

CP1

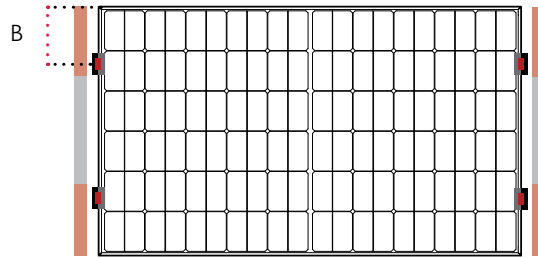

CP2

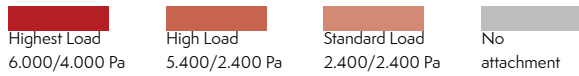

Line mounting

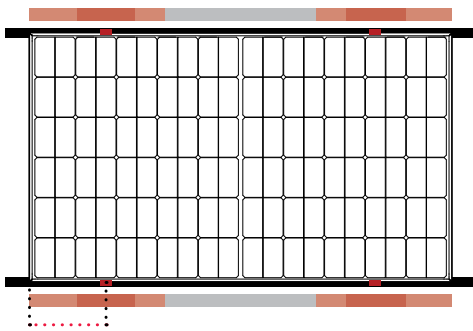

L

CL1

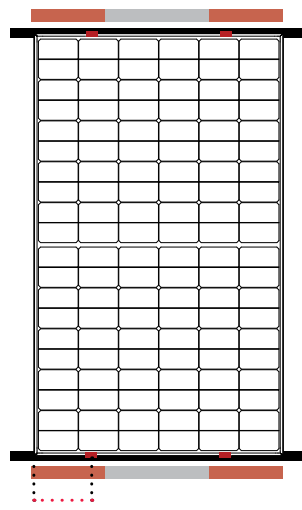

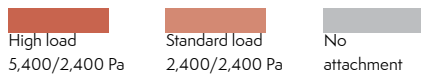

W

CL2



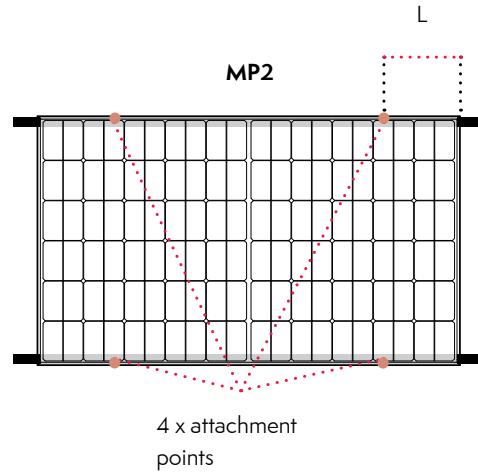
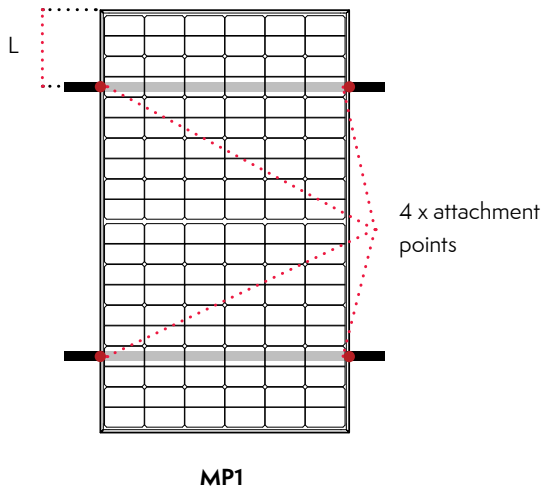

Installation using the mounting holes in the frame
Point mounting

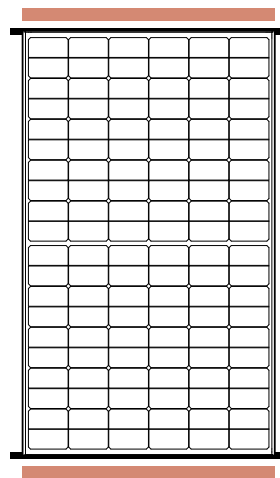
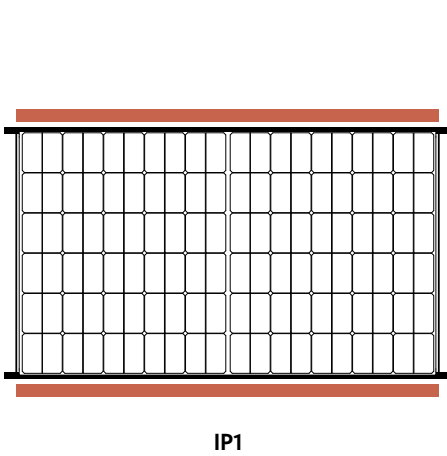

	
Highest load 6,000/4,000 Pa	High load 5,400/2,400 Pa

Installation with slide-in rails
Line mounting



	
High load 5,400/4,000 Pa	Standard load 2,400/2,400 Pa

Electrical connection

Safety

Always follow the safety instructions:

- Only qualified experts may perform the work.
- The applicable safety instructions and regulations must be observed.
- Open-circuit voltage (V_{oc}) is present even in poor light.
- Do not touch the solar modules with bare hands.
- Do not wear any metal jewelry when working with the modules.
- Use dry and insulated tools and wear insulated gloves.
- Do not modify the modules.
- Never connect or disconnect the modules under load. There is a risk of electric arc.
- To achieve maximum yields, only interconnect modules with similar electrical properties (same module class).

Installation

Take the following into consideration when commissioning the modules:

- The modules and tools must be dry during installation.
- Pay attention to the cable and connector polarities during connection.
- Check the modules, junction boxes, cables and connectors for damages and dirt and only install intact components.
- Please refer to the corresponding module data sheet for the maximum number of modules that can be connected, considering the maximum system voltage that may not be exceeded.
- We recommend using UV-resistant PV cables. They must have a cross-section of at least 4 mm² (12 AWG) and be heat-resistant at least up to 90°C (194°F).
- The minimum cable bending radius and its strain relief must be taken into account.
- The cables must not be run over sharp edges without protection.
- Protect the cables from direct sunlight, the effects of weather, and animals.
- Always connect the cable with a suitable equal connector, do not pinch it and protect it from mechanical loads.
- Do not connect different modules or modules with different orientations and tilts to the same string.
- Connect the module string to an inverter suitable for the configuration.
- Connect the PV system to the local lightning protection system.

Grounding

- In order to ensure electrical and fire safety, Meyer Burger solar modules must be grounded in accordance with the national, regional and local regulations.
- Article 250 of the U.S. National Electrical Code (NEC) covers the grounding and bonding of electrical systems within the US. Follow the rules of the NEC accordingly.
- Meyer Burger modules are equipped with pre-drilled grounding holes along the frame as specified in the module data sheets (www.meyerburger.com). Grounding holes are marked with the following symbol:



- Do not use different holes for grounding purposes and do not drill any additional holes inside the module frame.
- The frames of Meyer Burger modules are made of aluminum and coated with an anodized layer to protect against corrosion. Penetration of the anodized layer is necessary for proper grounding and/or bonding. Use special technical means (e.g. star washer, toothed washer) to penetrate the anodized layer.
- Meyer Burger only recommends using UL listed and certified methods as shown below:

Method 1: Use a certified grounding mean

- We require the installation of the certified equipment from ILSCO Corp. in the displayed order of installation in the picture.
- Use a stainless steel bolt and nut, a star washer and a spring washer.
- The tightening torque of the grounding lug to the module frame shall be 20 lbs-in (2.3 Nm).
- The tightening torque of the in-field grounding wire (12 AWG) shall be 20 lbs-in (2.3 Nm).

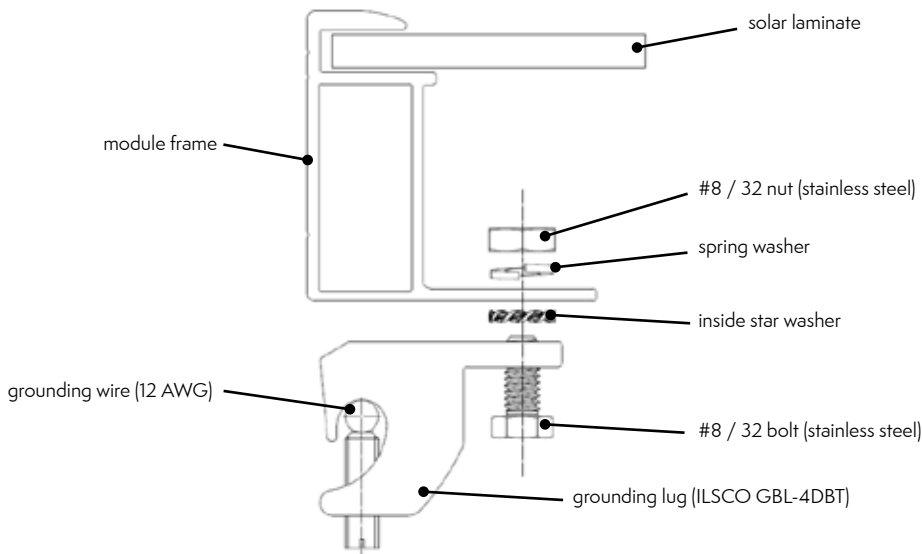

Ground lug GBL-4DBT, ILSCO CORP, UL File-No. E354420

Method 2: Use a mounting system integrated grounding

- Electrically bond Meyer Burger solar modules to UL2703 certified integrated grounding methods of a mounting system.
- To ensure system safety, the entire mounting system must be grounded according to the manufacturer's installation instructions.
- Meyer Burger modules must be listed on the system certificate.
- Strictly follow the installation instructions of the system manufacturer.
- Examples of this grounding method are the use of pin clamps or special washers within a certified system for proper bonding of the solar module.

Maintenance and cleaning

Maintenance:

- Have an installer check the system regularly (annually).
- Check the glass surface, the frames and the connections for any damage.
- Check the electrical components to ensure that they are free from corrosion and have a good contact.
- If a module needs to be replaced, follow the instructions for disassembly and assembly. In addition, use a module with the same electrical properties.
- After an unusual weather event (storm, hail, heavy snow, etc.), have an installer check the module for damage.

Cleaning:

- Do not use abrasive cleaning agents such as abrasive powder, steel wool, or scrapers.
- Do not use any cleaning devices made of steel or chemical cleaning agents.
- Strictly avoid using acids, alkalis, bleaching powder or strong bases.
- Do not use high-pressure cleaners for cleaning.
- Take care when cleaning sand or heavy soil to avoid scratches.
- Cleaning products should be checked for ingredients before use.
- Never touch the glass with your bare hands because you could leave fingerprints.
- Only clean the modules once they have cooled down.
- Remove leaves, snow, ice or other impurities carefully using a broom.
- Use cleaners containing alcohol (ethanol, isopropyl alcohol) for manual cleaning or hand washing. Do not use cleaners that are very acidic or alkaline, cleaners with hydrofluoric acid (HF) and pure alcohol or pure acetone. The modules can also be cleaned using a soap and water solution. Please make sure to remove any traces of cleaning agent from the glass surface.
- Use diluted alcohol or diluted acetone. Generous amounts of deionized (DI) water can be used for cleaning.
- Remove heavy soiling using plenty of water before wiping the glass surface. Leave stubborn dirt to soak where necessary.

Troubleshooting

In case of a disruption, contact the installer or MBI's technical support.

Disassembly/Recycling

Consult the data sheets of the system components as well for system disassembly:

- Only qualified experts may perform the work.
 - Switch off the inverter and wait until it disconnects.
 - Disconnect the module from the inverter.
 - Check the components for damage.
 - Only disconnect the connectors using an appropriate tool.
 - Disassemble the modules and racking using an appropriate tool.
- Pack the modules and other components for safe transport.
 - Observe the local regulations for recycling or disposal.
 - Collection and return of the modules is taken care of by our partner take-e-away. For more information, visit: <https://kundenportal.take-e-way.de/>

Meyer Burger (Industries) GmbH

Carl-Schiffner-Str. 17
09599 Freiberg
Germany

