



DC224-6

DEEP CYCLE

224AH @ 20Hr
6-Volt

Group Size: GC2

Maintenance-Free
Sealed AGM Battery

CYCLING CAPACITY

20 Hour Rate **224 Amp Hours**

RESERVE CAPACITY

Reserve @25 AMPS **441 Minutes**

Reserve @75 AMPS **113 Minutes**

ELECTRICAL SPECIFICATIONS

Nominal Voltage	6 Volt
C100	250AH
C20	224AH
C10	194AH
C5	179AH
CCA	900
CA or MCA	1080
HPCA	2000 Amps
Internal Resistance	1.5m Ω

MECHANICAL SPECIFICATIONS

Group Size	GC2	
Terminal Type	M8 (removable Brass AP (TP08))	
Terminal Torque	See reverse side	
Height (w/ terminal)	10.71"	272mm
Height (case only)	9.65"	245mm
Width	7.09"	180mm
Length	10.24"	260mm
Weight	67.9 lbs.	30.8 kg
Case Type	ABS Plastic - Flame Res. Rating UL94-HB	

DISCHARGE TABLE (Constant Current)

Time	Amps	Rate
20hr	11.2	0.05CA
10hr	16.6	0.10CA
8hr	23.5	0.13CA
5hr	35.8	0.25CA
3hr	48.9	0.33CA
2hr	66.1	0.50CA
1hr	119.1	1.00CA

DISCHARGE PROFILE (Constant Current)

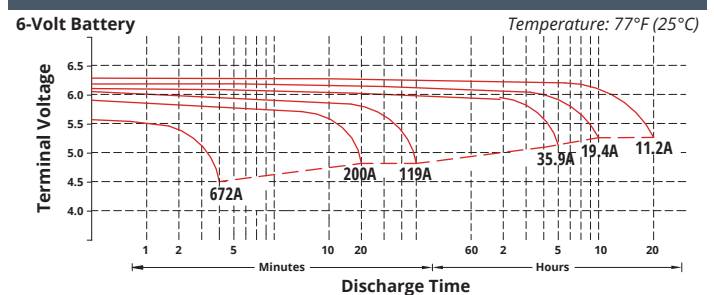

- All listed ratings are @ 100% SoC, T=77°F (25°C), 1.75VPC unless otherwise specified.

- Specifications listed are for estimation purposes only. Battery performance can vary depending on application. Battery design subject to change.

BATTERY & TERMINAL DIMENSIONS (All units shown in mm)

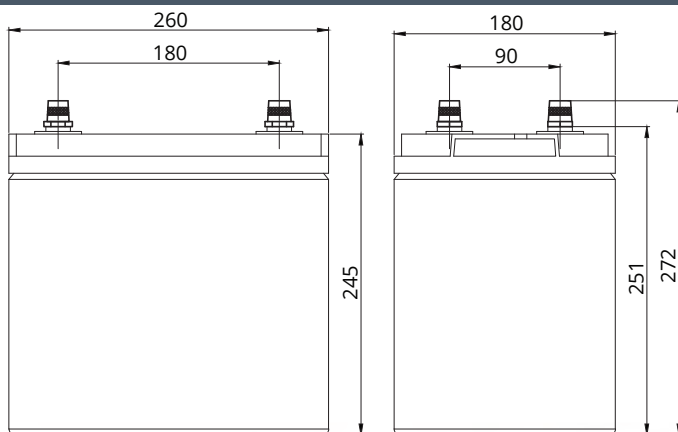

Terminal: M8 with TP08 Brass AP

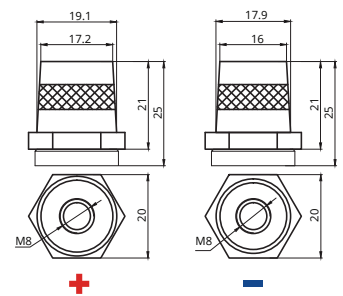

Battery bank spacing required,
12.5mm (1/2" inch) minimum

(unit: mm)



DC224-6 DATA SHEET

fullriverbattery.com

TEMPERATURE vs CAPACITY

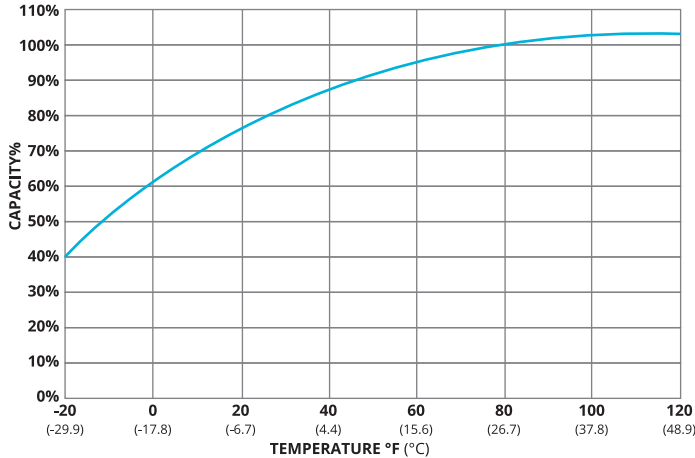

STATE of CHARGE (SOC) vs OPEN CIRCUIT VOLTAGE (OCV)

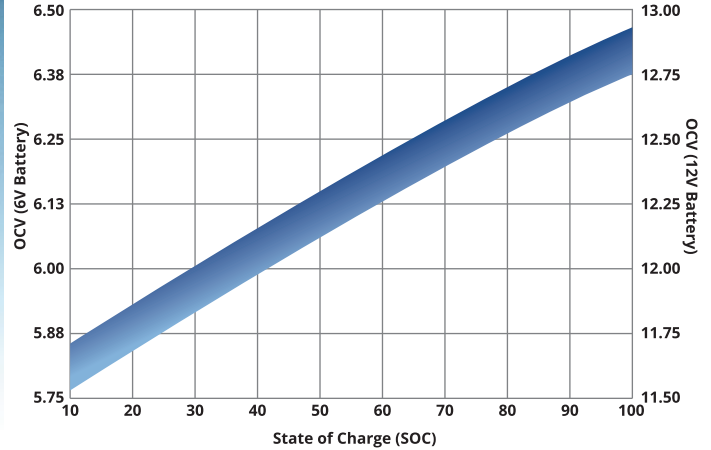

CYCLE LIFE vs DEPTH of DISCHARGE (DOD)

*(Based on BCI Testing @ 2-hr Rate)

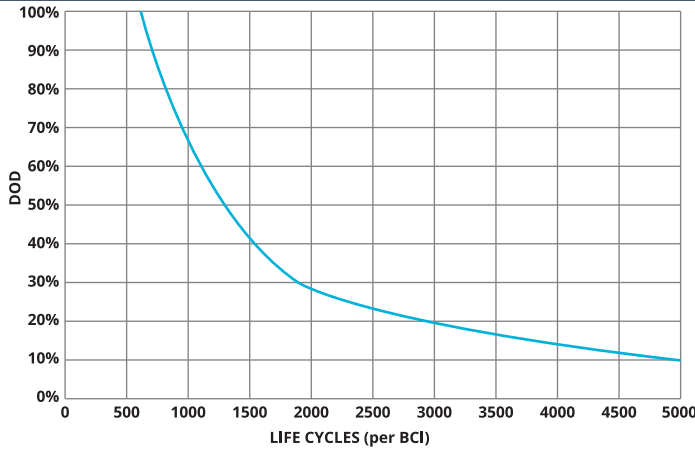

SELF DISCHARGE vs TIME/TEMPERATURE

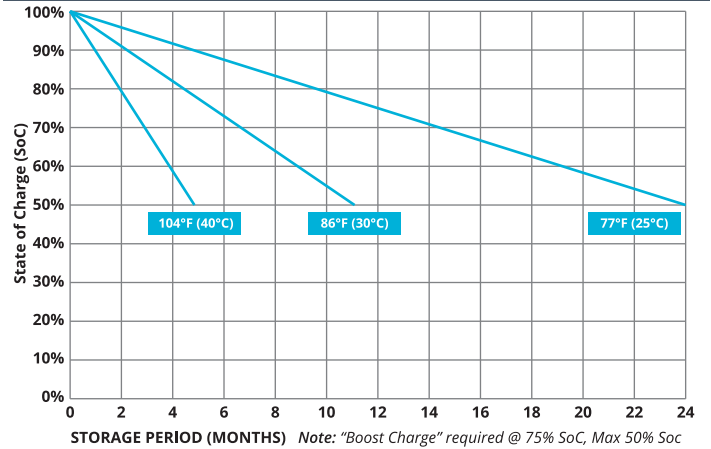

TEMPERATURE RANGE SPECIFICATIONS

Condition	Recommended	Maximum	Recommended	Maximum
Storage	5°F to 122°F	-40°F to 160°F	-15°C to 50°C	-40°C to 71°C
Operation	5°F to 104°F	-40°F to 160°F	-15°C to 40°C	-40°C to 71°C
Charge with TC	5°F to 122°F	-40°F to 160°F	-15°C to 50°C	-40°C to 71°C
Charge w/o TC	32°F to 104°F	5°F to 122°F	0°C to 40°C	-15°C to 50°C

*TC= Temperature Compensation

CHARGE VOLTAGES

Charge Stage	Battery Voltages			
	12V	24V	36V	48V
Bulk	14.7V	29.4V	44.1V	58.8V
Absorption	14.7V	29.4V	44.1V	58.8V
Float	13.6V	27.2V	40.8V	54.6V

TC Factor: (-2mV°F/cell) or (-4mV°C/cell)

TERMINAL TORQUE SPECS

Terminal Type	ft-lbs	in-lbs	Nm
AP, DT (AP), M6, M6M (Stud), TP07 (AP), TP08 (AP)	4.2 - 6.0	50-70	5.6 - 7.9
FR45	6.0 - 7.5	70-90	7.9 - 10.1
M8	7.1 - 8.0	85-95	9.6 - 10.7
DT (Stud), M10M (Stud)	9.2 - 10.4	110-125	12.2 - 14



9001:2008 Quality Management System
 14001:2004 Environmental Management System
 18001:2007 Occupational Health & Safety Management System



DELIVERY APPROVED!
**LAND, SEA
 & AIR**

Fullriver batteries are sealed lead acid batteries made with Absorbed Glass Mat (AGM) technology. The electrolyte is absorbed into the fiberglass separator material rather than in a free-flowing liquid form. Fullriver batteries are non-spillable electric storage batteries. They are exempted from the requirements of DOT's hazardous materials regulations, since they adhere to the requirements of code 49 CFR Section 173.159(D) - (CLASSIFIED APPROVED: DOT, CFR, HMR49, IATA, ICAO67, IMDG27)