



Franklin Home Power Quick Installation Guide

Version 1.1.05

Issued on: March 04, 2024

The installation, wiring, maintenance, transportation, and handling of each aGate and aPower should follow local laws, regulations and standards, and the Safety Instructions in this Guide serve as supplementation to the laws, regulations, and standards.

Only FranklinWH certified and qualified technicians can install, maintain, or replace aGate and aPower equipment or wiring.

Refer to the [Franklin Home Power Installation Guide](#) for more information.

Installation Preparations

Site Planing



NOTE: The selection of installation location must avoid water and power conduits. Refer to all applicable local codes and standards.

In Canada, it's required to install the system indoors to maintain the specified operation temperatures.

The details below are general guidelines for installing space and are not guaranteed to be applicable. Please consult your local AHJ or Utility before use.

1. Choose a mounting location that can bear the weight of the aGate, aPower and bracket.
2. The details below are general guidelines for spacing and may not be applicable. Please consult with your local AHJ or Utility before finalizing the spacing.

aGate

- a) There should be at least 6 in. (0.15 m) of clearance from the top of aGate to the ceiling, and 36 in. (0.91 m) of clearance in front of the aGate.
- b) The recommended distance between the bottom of aGate and the ground is 48 in. (1.2 m), not exceeding 52 in. (1.3 m) i.e., the maximum distance between the power switch button on the aGate and the ground shall not exceed 79 in. (2 m) per the NEC requirements.

aPower

- a) There should be a minimum clearance of 6 in. (0.15 m) from the top of aPower to the ceiling.
- b) For the aPower mounted on a wall or floor, the maximum distance between the bottom of the aPower and the ground shall be ≤ 42 in. (1.1 m) i.e., **the maximum distance between the aPower switch button and the ground shall not exceed 79 in. (2 m) per NEC 404.8(A) requirements.**
- c) For multiple aPowers installed at the same height, the minimum separation between adjacent aPower units or side walls should be more than 4 in. (0.1 m).

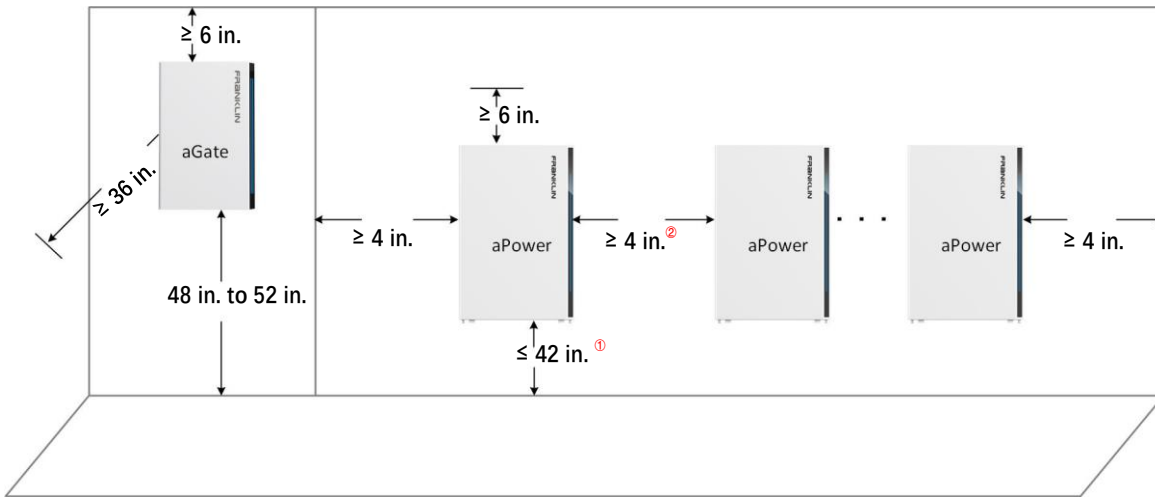

① NEC 408.4(A) requires the aPower switch to be no more than 79 in. (2m) from the ground.

② 4 in. (0.1 m) between adjacent aPower units or side walls is UL9540A required clearance. Refer to all applicable local codes and standards.

| Connection | Maximum cable length |
|--------------------|----------------------|
| aPower to aGate | 98.4 ft (30 m) |
| aGate to Generator | 98.4 ft (30 m) |
| Split CT to aGate | 49.2 ft (15 m) |

Tools Needed



Torque Requirements

| Screw Type | Cross head screwdriver | Tightening torque |
|------------|------------------------|---------------------|
| M4 | PH2 | 1.03lbf·ft (1.4N·M) |
| M5 | PH2 | 2.21lbf·ft (3.0N·M) |
| M6 | PH3 | 4.42lbf·ft (6.0N·M) |

Over Current Protection Device (OCPD) in aGate

| Name | Max Continuous Current | Max. OCPD |
|---------------------------|------------------------|-----------|
| Solar terminal | 64A | 80A |
| aPower terminal | 80A | 100A |
| Smart Circuits 1, 2 | 40A | 50A |
| Smart Circuit 3 | 64A | 80A |
| Grid terminal | 160A | 200A |
| Backup load terminals | 160A | 200A |
| Non-backup load terminals | 160A | 200A |
| Generator terminal | 160A | 200A |

* Bus bar amp rating is 280A.

aGate Installation

Remove the Inner Panel and Door from the aGate

Remove the aGate inner panel and door and properly store them.

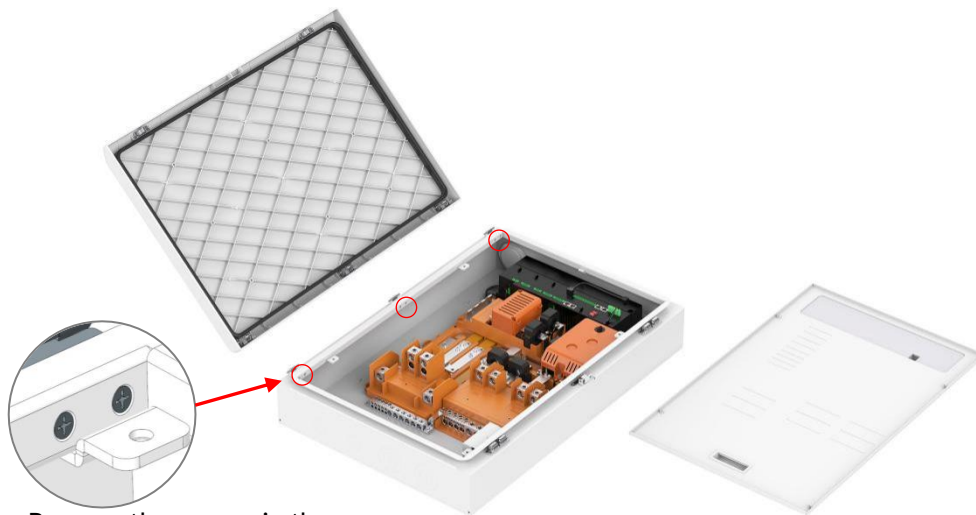

Remove the screws in the red circle from inside

Install optional module(s)

FranklinWH provides optional Smart Circuits and Generator Modules. For Smart Circuits Module and Generator Module installations, refer to [FranklinWH Smart Circuits Module Installation Guide](#) and [FranklinWh Generator Module Installation Guide](#).

Install breakers as needed

Install breakers for solar, aPower, Smart Circuits (if Smart Circuits Module installed), the backup panel, grid, and generator (if Generator Module installed), according to local laws, regulations, standards, and National Electric Codes (NEC), ANSI/NFPA 70 or Canadian Standards Association CSA C22.1. These breakers are not included and must be ordered separately. Refer to [Appendix](#) for compatible breakers.

Breaker installation positions are noted in the image below:

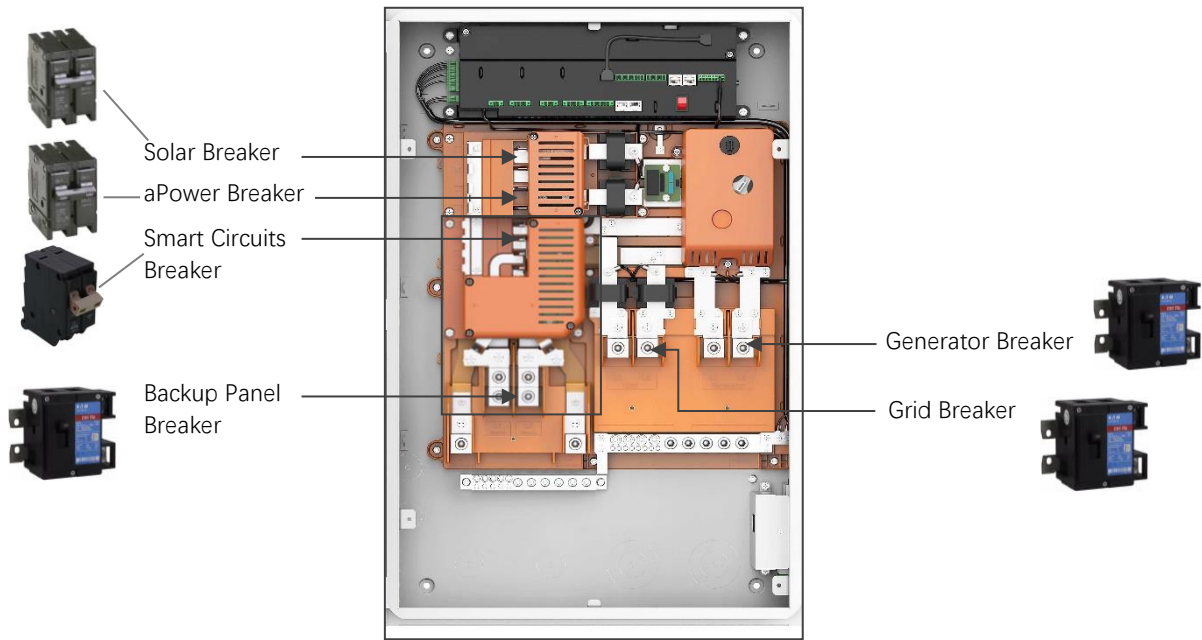

- 1) Before installation, make sure that the aGate is de-energized and the upstream and downstream switches are disconnected and padlocked during installation.
- 2) Install a solar breaker, an aPower breaker, and smart circuits breakers at the location indicated on the image above.
- 3) Fasten the aPower breaker according to the following steps as per NEC requirements.
 - a) Insert the circuit breaker holder card firmly into the middle space of the aPower breaker in the direction shown in the image below.

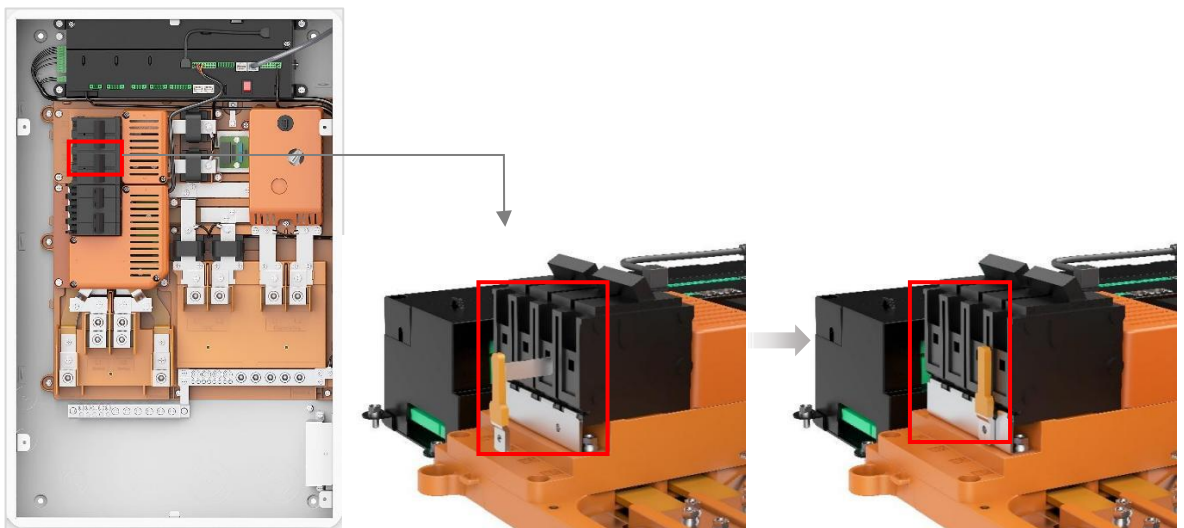

- b) Insert the fixing plate, turn the screw by hand to seat the circuit breaker.

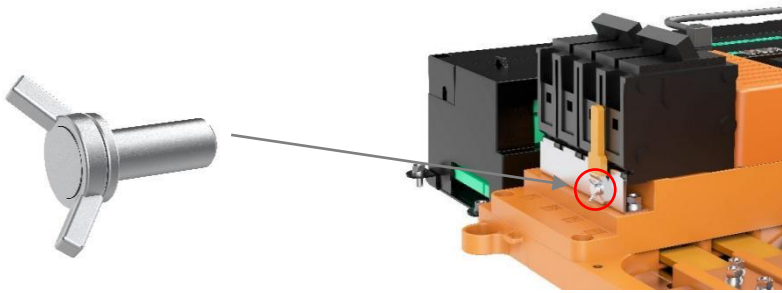

- 4) Before installing a backup panel breaker, a grid breaker or a generator breaker, remove the connected lugs. When breakers are used, the lugs are replaced with breakers during installation. When breakers are not installed, the conductors can be directly connected to these lugs. Follow the instructions below to remove the lugs and install the breakers:
- Using a Phillips head screwdriver, remove the two M6 x 16 combination bolts holding the lugs and save it for later use. Then remove the lugs.
 - Use the two M6 x 16 combination bolts to fix the breaker. Then use the M4 x 10 screw to secure the breaker. Using a Phillips head torque screwdriver, tighten the M4 screw to 1.03 lbf·ft (1.4 Nm).
 - Stick the provided **L2 Backup L1**, **L2 Grid L1**, and **L2 Generator L1** labels below backup panel breaker, the grid breaker, and generator breaker respectively.

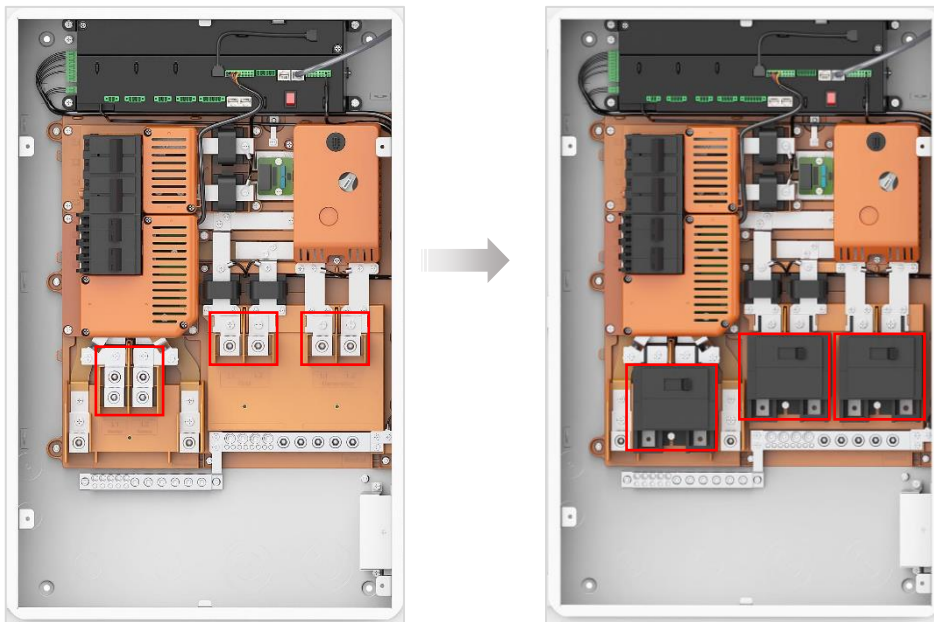

NOTE: The aGate's utility grid circuit breaker is only required where the aGate is used as service entrance equipment or there are no other circuit breakers protecting the conductors feeding the aGate's utility grid connection.

The generator breaker may be installed outside the aGate depending on the site condition.

Mount the aGate on a Wall

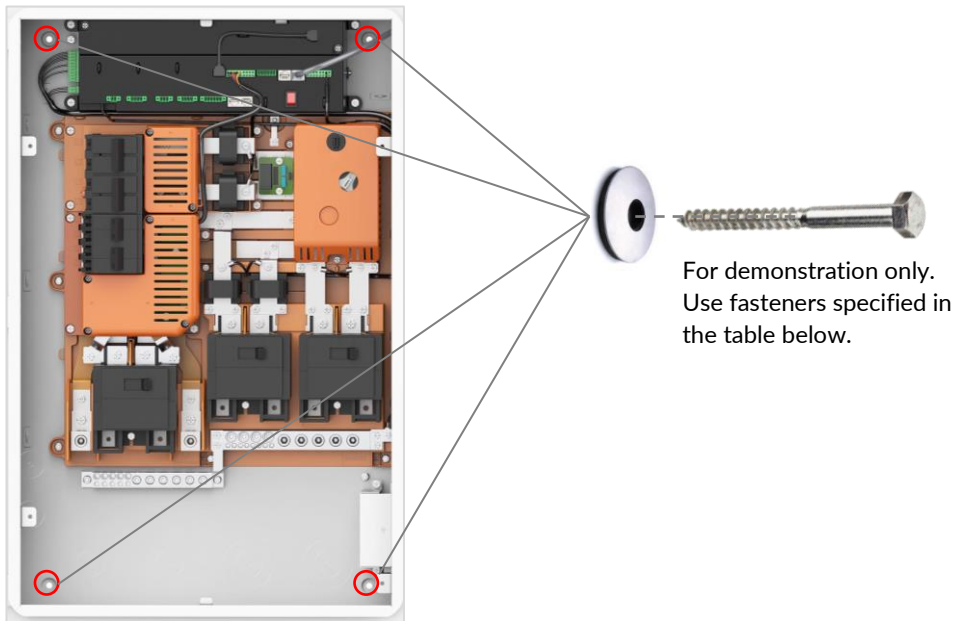

See drilling details and the fasteners in the table below for more details on the hole depth and type of fasteners to use corresponding to different types of walls.

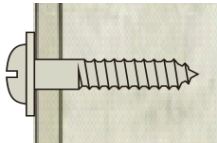
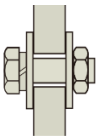
| | | |
|--|---|---|
| <p>Concrete or brick structures</p> | <p>Hole depth: Minimum 1-1/2" (38 mm) Fastener: 1/4" (6.35 mm) water-tight washer, spring washer, and nuts</p> |  |
| <p>Wooden beams</p> | <p>Hole depth: Minimum 2.5" (64 mm) Fastener: 1/4" (6.35 mm) water-tight washer, wood screw with a large flat washer,</p> |  |
| <p>Steel beams</p> | <p>Hole depth: Through the steel beam Fastener: 1/4" (6.35 mm) water-tight washer, 1/4" (6.35 mm) stainless steel hex screws with spring washer and large flat washer and hex nuts</p> |  |

aPower Installation

Mount the bracket on a wall

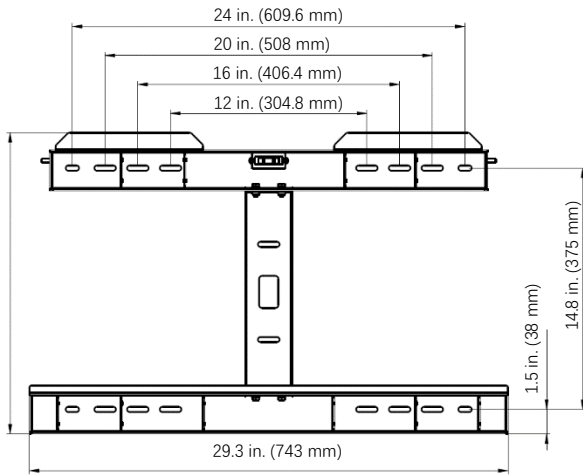

| | |
|--|--|
| <p>Wooden beams</p> <p>At least 4 1/4" stainless steel wood screws with large flat washers (1 at each corner), at least 2.5" (64 mm) of each screw inserted into the wooden beam.</p> | |
| <p>Steel beams</p> <p>Use at least 4 1/4" stainless steel hex screws (1 at each corner) with spring washers, large flat washers and nuts to secure the bracket to the steel beam.</p> | |
| <p>Concrete or brick walls</p> <p>Use at least 4 1/4" stainless steel expansion screws (1 at each corner) with spring washers and large flat washers and at least 1.5" (38 mm) length embedded in the wall. Place screws at least 1.5" (38 mm) away from brick edge</p> | |

Drill conduit entry holes on the wall (if needed)

Drill conduit entry holes on the wall if needed. If there is any metal or wooden supporting structure in the drilling area, necessary adjustments are required to avoid it.

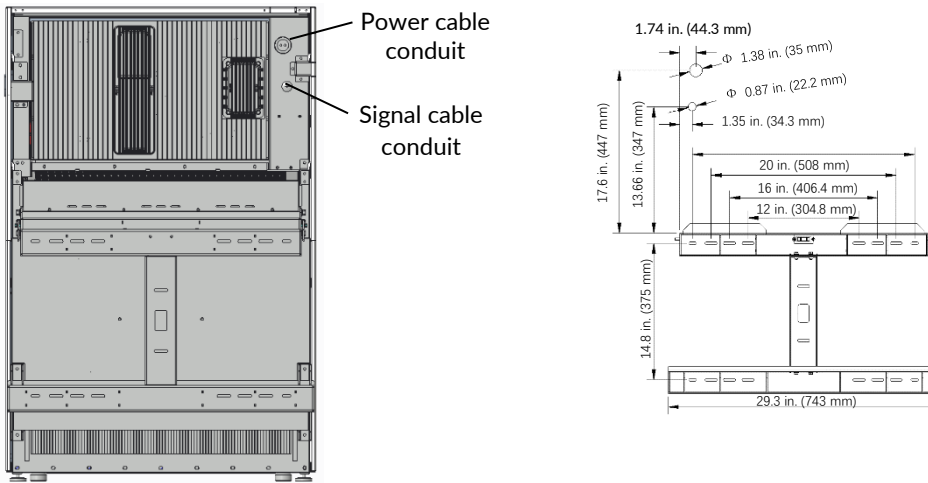

DANGER: Avoid drilling holes in water pipes and cables in the wall. PPE must be used in the operation.



WARNING: Cover the aPower top heat dissipation hole to protect from gravel dust during drilling.

Mount the aPower in the bracket

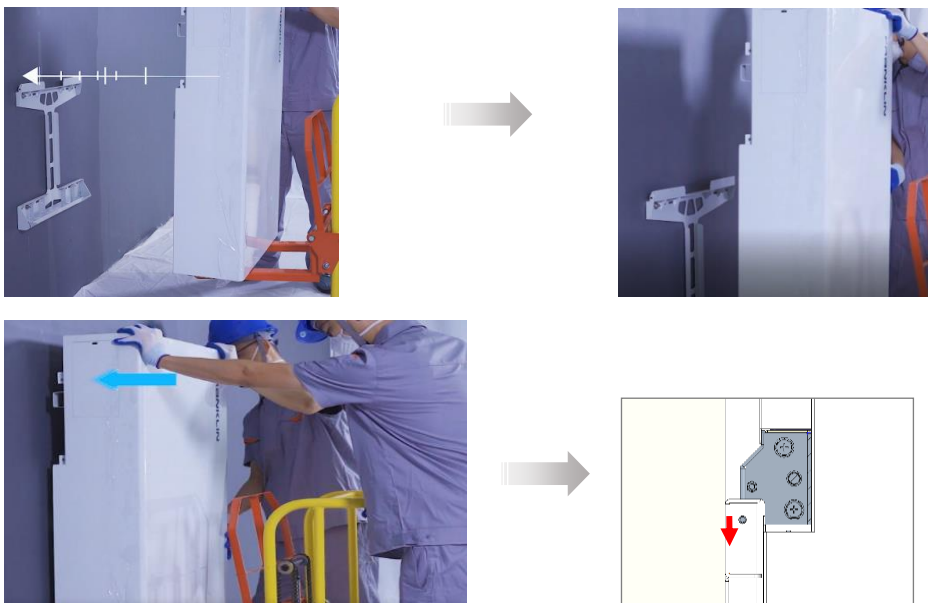

After the aPower is firmly set on the mounting bracket, attach and fasten the two retainer plates to both sides of the upper bracket using M5*20 screws, tighten to a torque of 3 Nm.

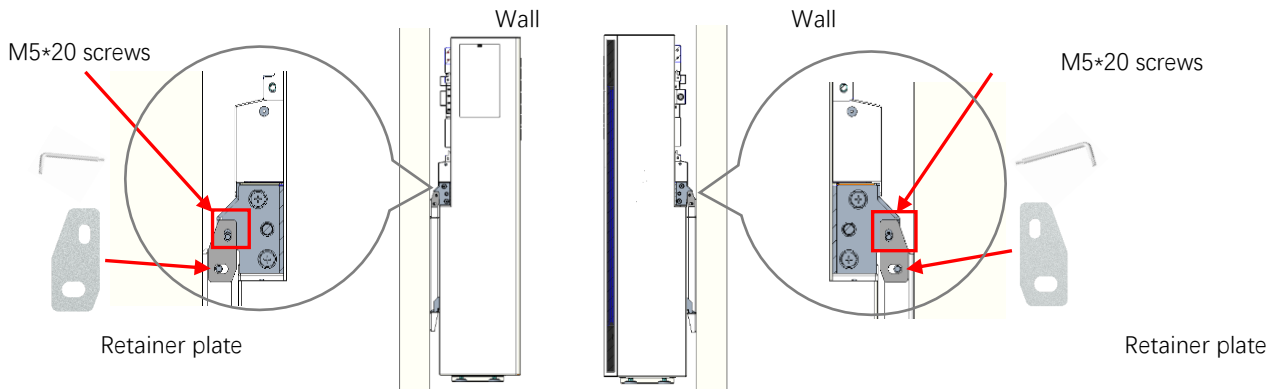

Level the floor mounted aPower

If the aPower is to be installed on an uneven floor, the leveling screws on the bottom of aPower cabinet can be adjusted until the screw directly contacts the floor.

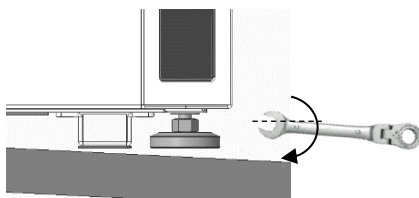
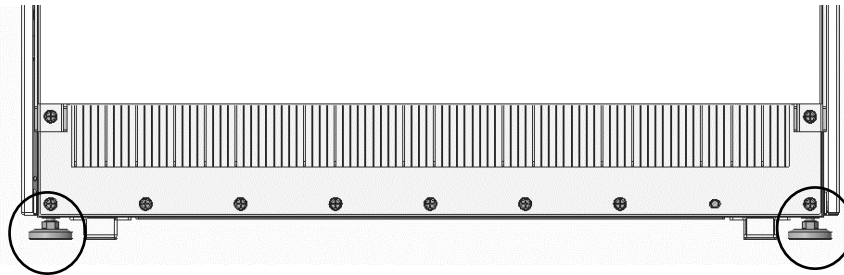

Using a No. 13 open-end wrench, turn the nut clockwise to loosen it.

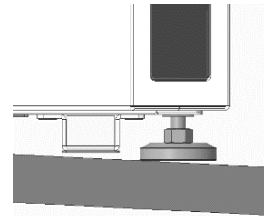

Turn the bolt head clockwise until the screw head hits the ground.

Communications Wiring

Before wiring, check and ensure that the Com Kit (4G and Wifi) cable is connected between the Com Kit port on the EMS module and the Wireless module.

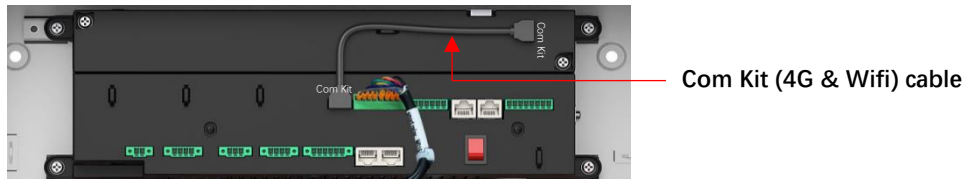

WARNING: Only use the cable supplied with the equipment. The aGate cannot be activated if this step is not completed.

Establish communications between the FranklinWH App and the aGate

Connect the mobile device to the aGate hotspot network to establish a local communications connection between the FranklinWH App and the aGate using the following account and password:

Account: AP_last 9 digits of serial number

Password: last 12 digits of serial number



NOTE: The account and password can be modified through the FranklinWH App.

Connect the aGate to the home internet network

- Method 1 (Recommended):** Connect the aGate to the home internet using a communications cable

To ensure the reliability of remote communications, it is recommended to connect the home network cable with internet connection to the **Eth2** port of EMS module.

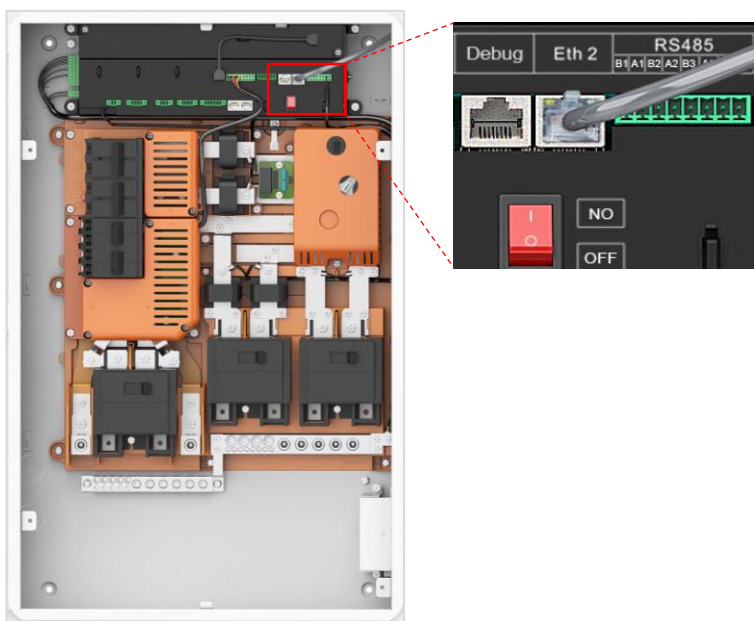

2. Method 2: Connect via Wifi

The Wifi connection between the aGate and home wireless network should be done during commissioning. Please refer to the *Franklin Home Power Commissioning Guide*.

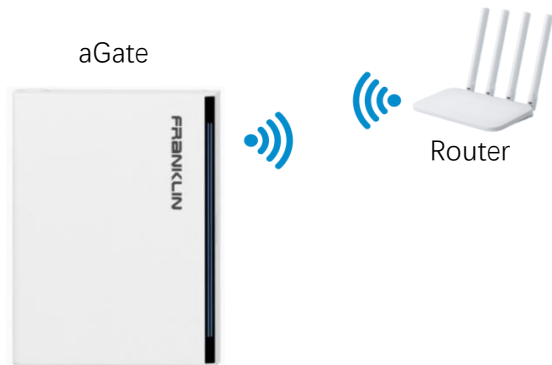

**NOTE: The aGate supports only 2.4Ghz Wifi connection to the family router.*

3. Method 3: Connect via telecommunication 4G network (only as backup)

Please make sure that there is a good 4G LTE signal in the local area and that a SIM card has been inserted into the slot on the wireless module.

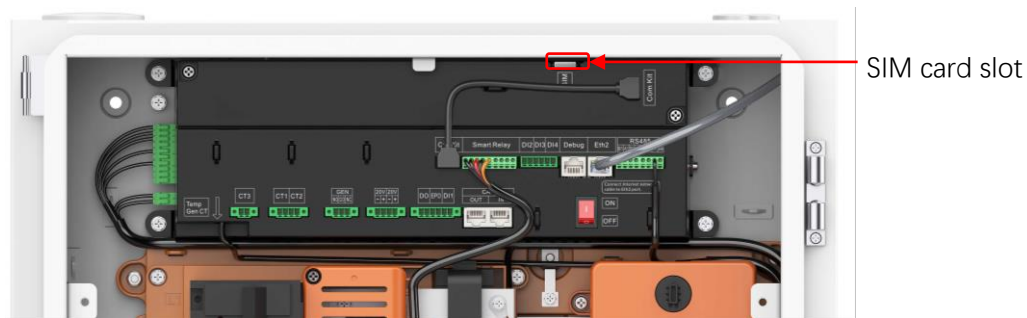

Establish communications between t the aGate and the aPower(s)

a) Communications connection between the aGate and a single aPower

a) If the distance between the aGate and the aPower is within 98 ft (30 m), use a minimum CAT5 cable to connect the aGate **CAN OUT** port to the aPower **CAN In** port in the wiring compartment.

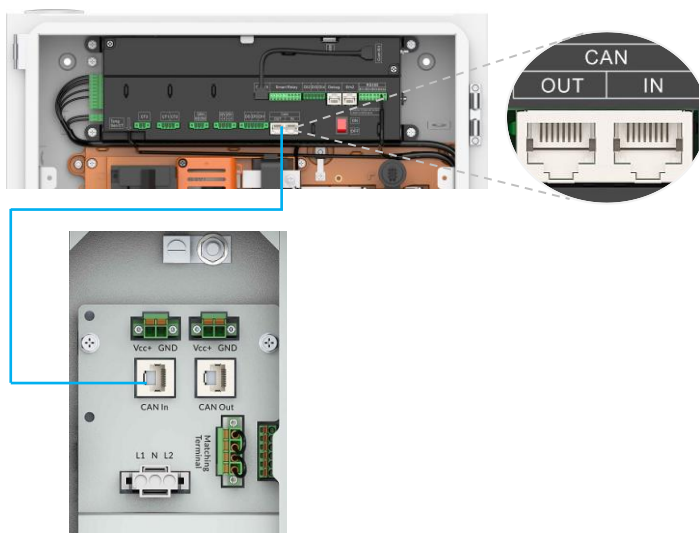

- b) If the distance between the aGate and the aPower is more than 98 ft (30 m), a 16~18 AWG 20 V power supply feed will be needed in addition to the communication cable. Connect the aGate 20V +/- ports to the aPower Vcc+ ports, as shown in the image below.

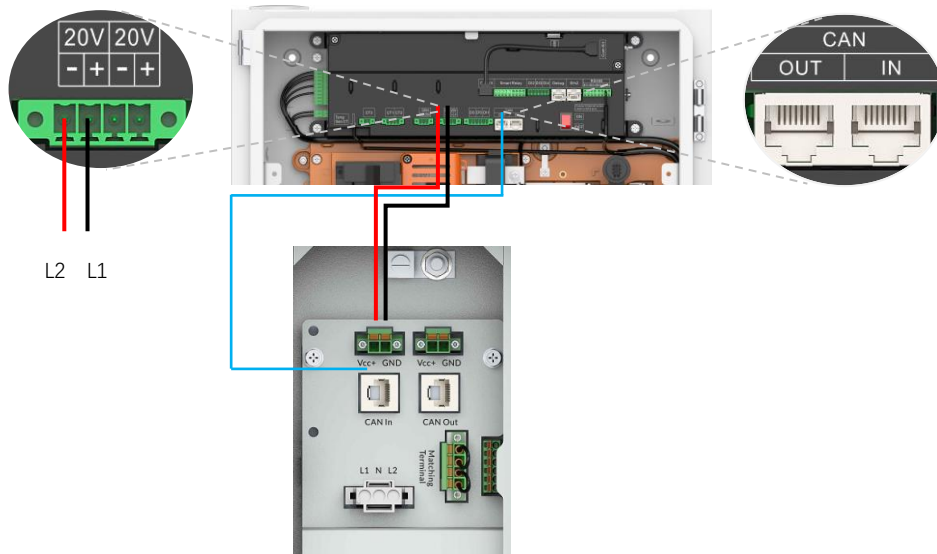

b) Communications connection between the aGate and multiple aPowers

- a) If the distance between the aGate and the first aPower is within 98 ft (30 m), use a minimum CAT5 network cable to connect the aGate CAN-OUT port to the CAN In port of the first aPower, and connect the CAN OUT port of the first aPower to the CAN In port of the second aPower, etc. Remove the matching terminals from all aPower units except for the one of the last aPower.

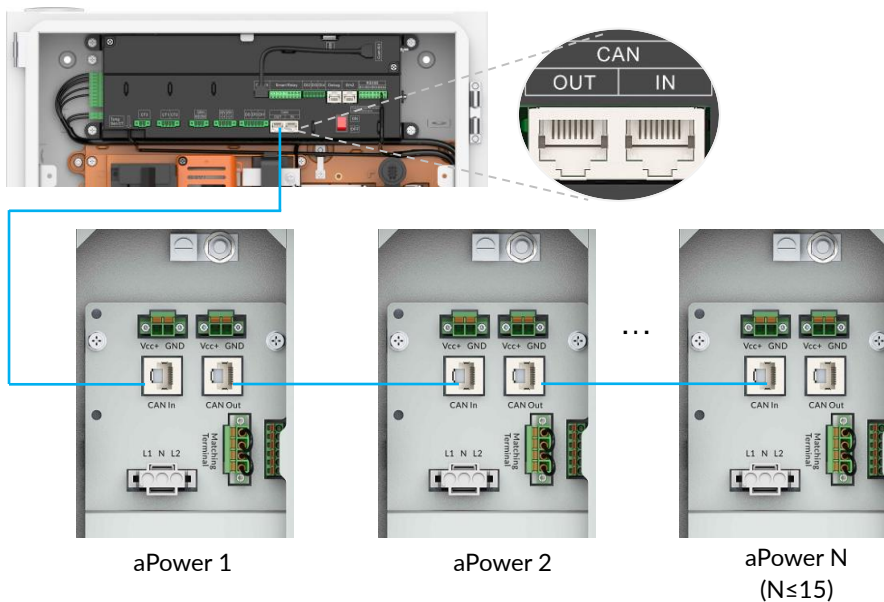

- b) If the distance between the aGate and the first aPower is more than 98 ft (30 m), a 16~18 AWG 20 V power supply feed will be needed in addition to the communication cable. Connect the aGate 20V +/- ports to the Vcc+ ports of the first aPower, as shown in the image below. Remove the matching terminals from all aPower units except for the one of the last aPower.

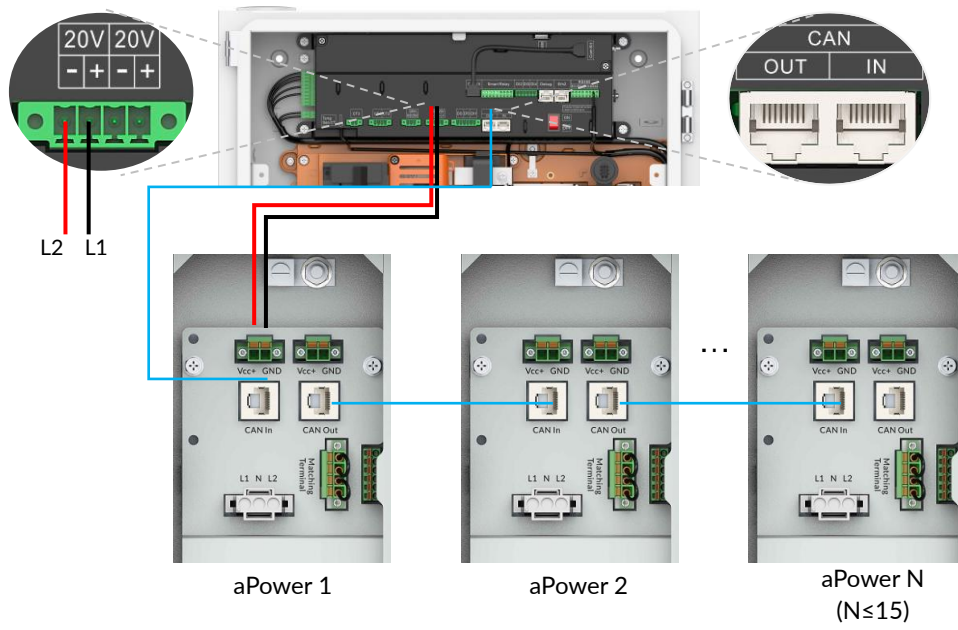

Electrical Wiring

Connecting the solar inverter to the aGate

When connecting a solar inverter to the aGate, the solar breaker is the only interface to be used. Do not connect the solar inverter to any other port.

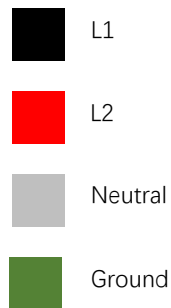
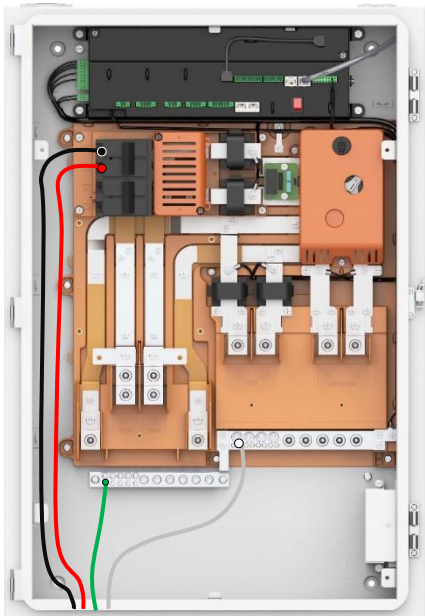

Connecting the backup panel to the aGate

Connect the backup panel conductors to the aGate terminals. Refer to [Wiring](#) for recommended cables.

After installation of the backup panel breaker, L1 and L2 will swap sides for connections (L2 is located to the left while L1 is to the right).

Without a backup panel breaker

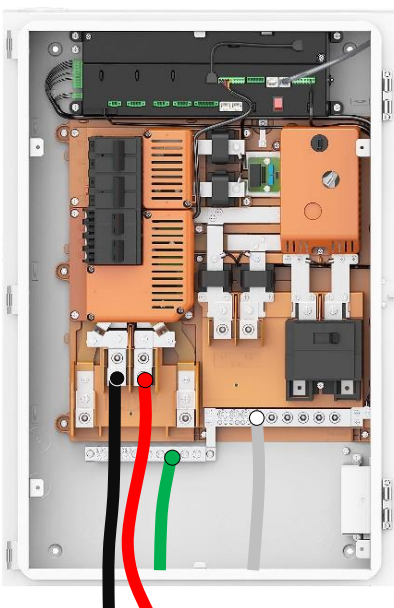

With a backup panel breaker

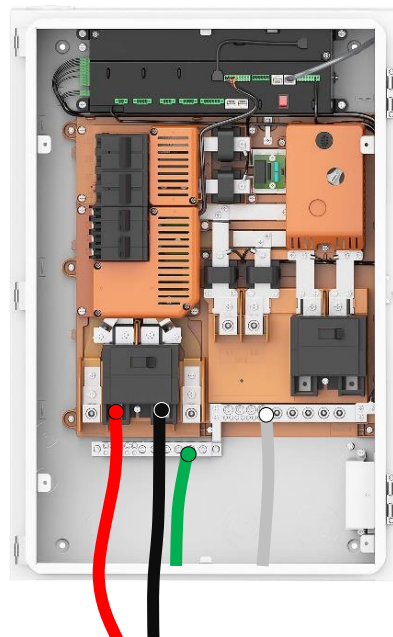

Connecting the grid supply to the aGate

Connect the grid supply conductors to the aGate terminals. Refer to **Wiring requirements** for recommended cables.

After installation of the grid breaker, L1 and L2 will swap sides for connections (L2 is located to the left while L1 is to the right).

Without a grid breaker

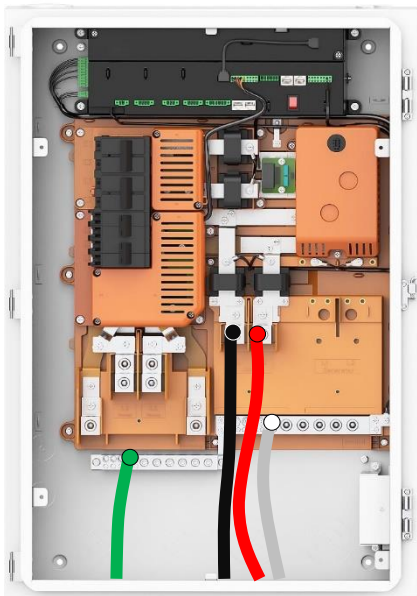

With a grid breaker

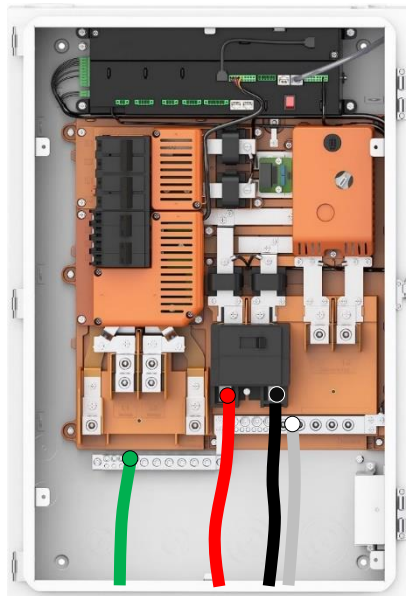

According to NFPA 70 250 Grounding and Bonding Part V, when installed as service equipment, the neutral and ground should be bonded together, as shown in the figure below.

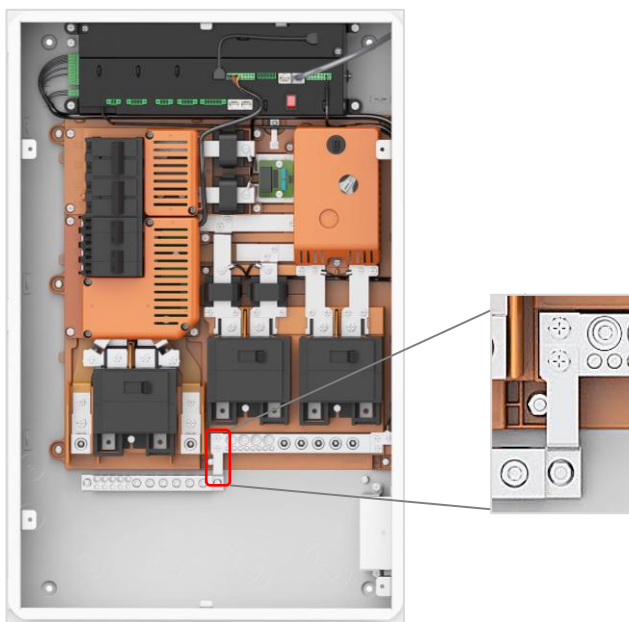

The Neutral-Ground Bonding Jumper must only be removed if not installed as Service Equipment, or for test purposes.

Connecting loads to Smart Circuits

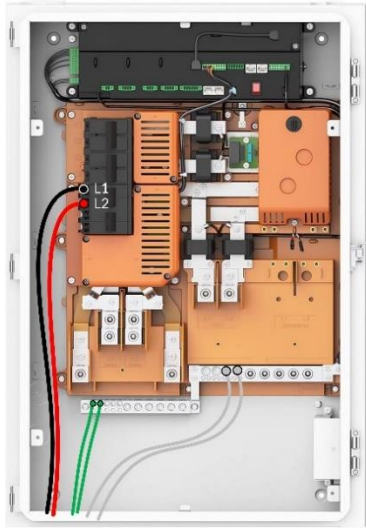
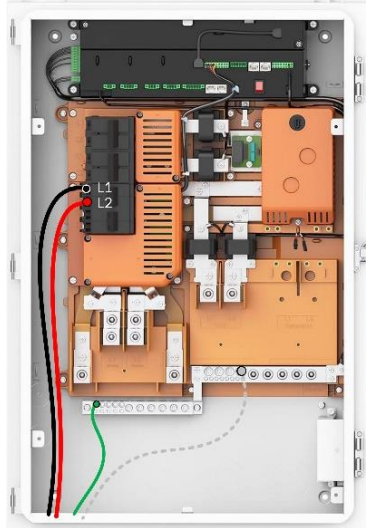
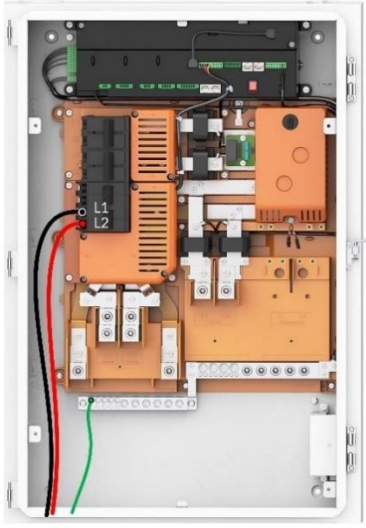
| Loads Connection to Smart Circuit 1 / Smart Circuit 2 | Loads Connection to Smart Circuit 1 and Smart Circuit 2 | Loads Connection to Smart Circuit 3 |
|---|---|--|
| <p>If Smart Circuit 1 and Smart Circuit 2 connect two 1-pole breakers, connect the load conductors to the Smart Circuit module output terminals on aGate (L1, L2, Neutral & Ground), as shown below.</p>  | <p>If Smart Circuit 1 and Smart Circuit 2 connect two 1-pole breakers, connect the load conductors to the Smart Circuit module output terminals on aGate (L1, L2, Neutral & Ground), as shown below.</p>  | <p>Smart Circuit 3 is only used for 240 V loads. Connect the load conductors to the Smart Circuit module output terminals on aGate (L1, L2 & Ground), and don't connect the loads neutral line to the aGate, as shown below.</p>  |

Connecting a standby generator to the aGate

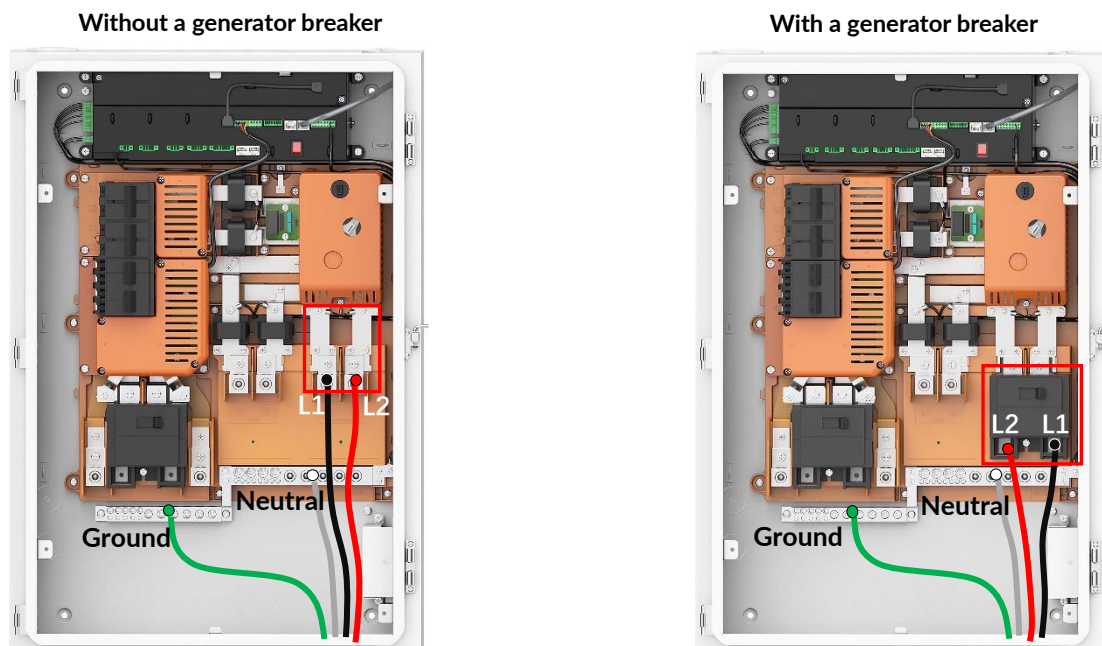

Connecting the aPower(s) to the aGate

Connecting a single aPower to the aGate

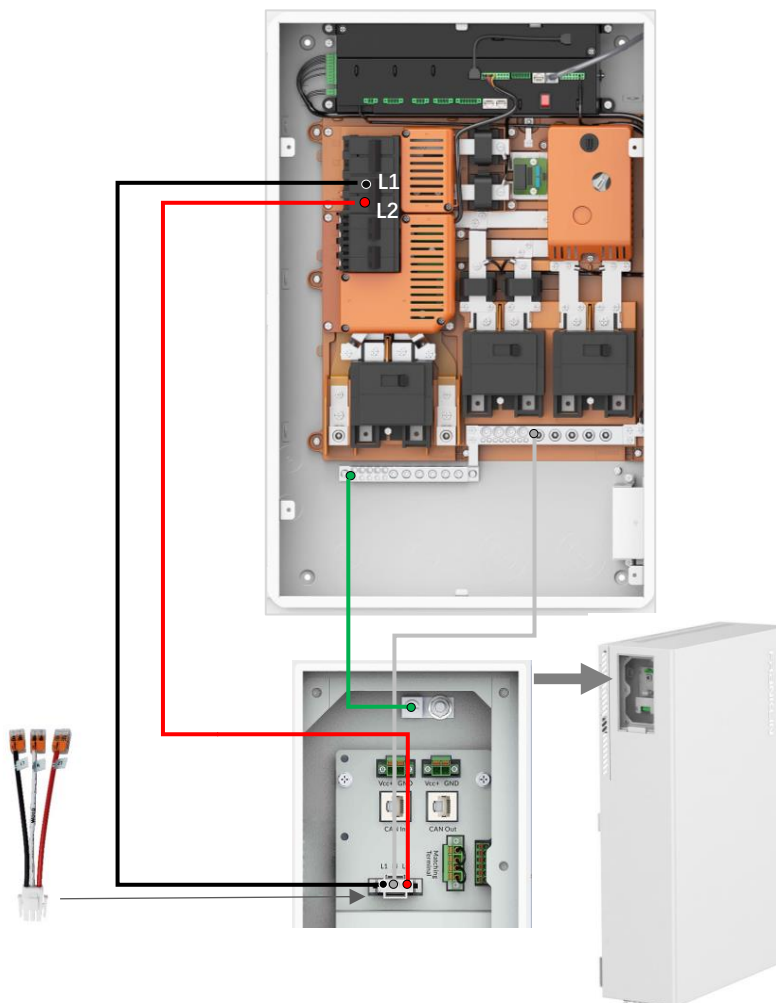

Connecting 2 or 3 aPowers to the aGate

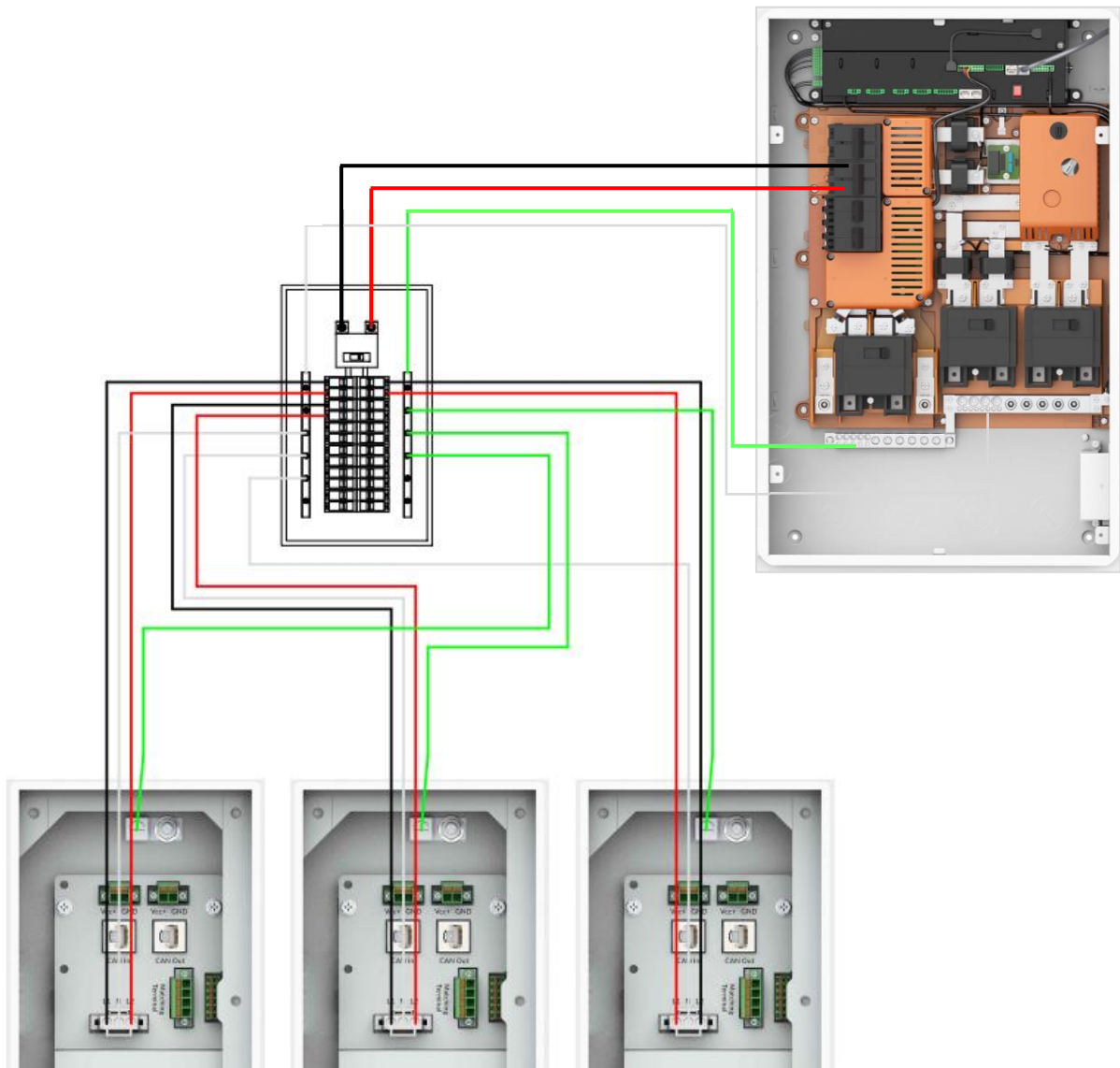

Connecting 4 or more aPowers to the aGate

For 4 or more aPowers, consult with FranklinWH technical support.

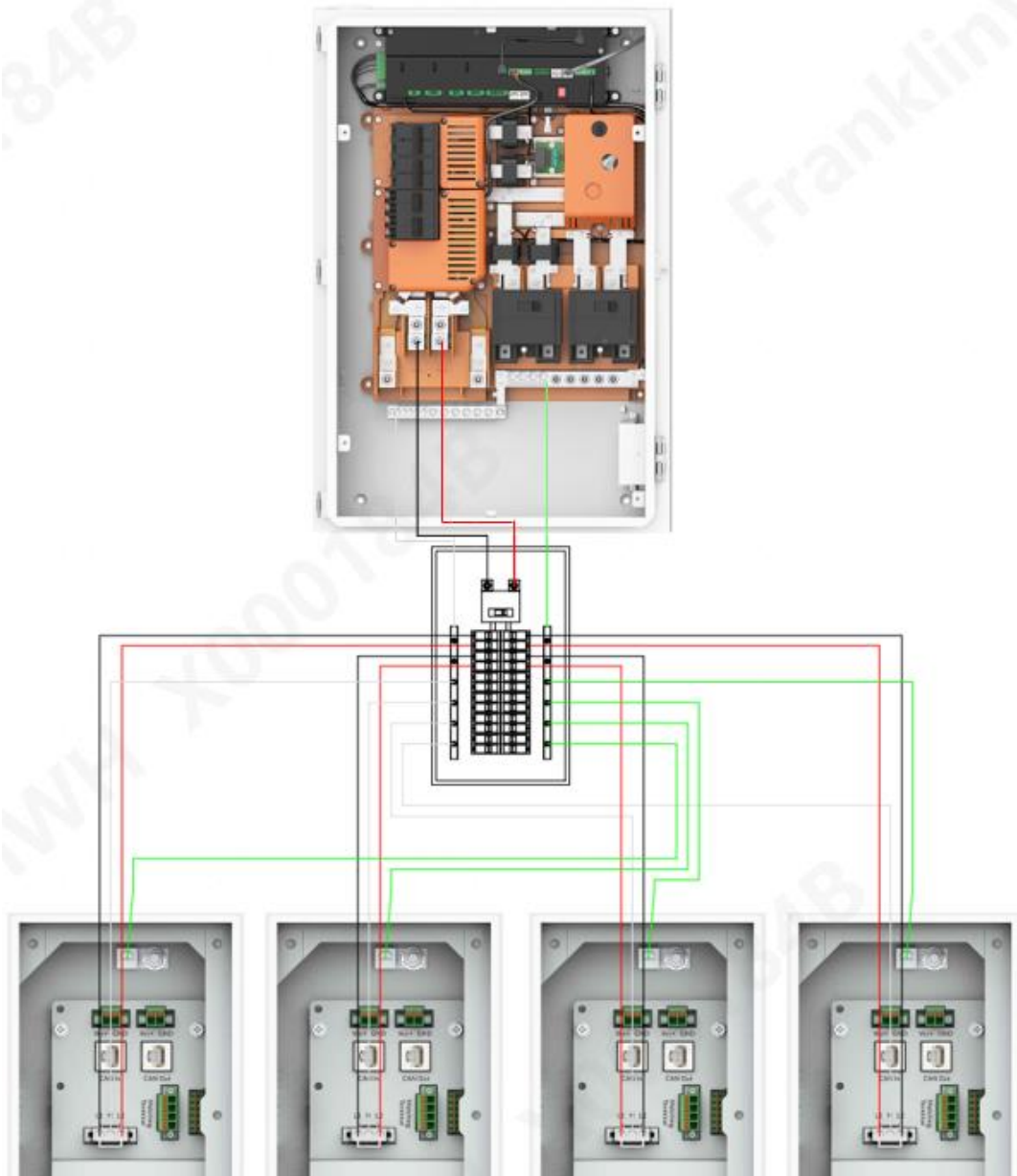

Wiring

| Terminal | Wire Gauge | Tool | Strip Length | Torque |
|---------------------|-------------------------|--|--------------------------------|---|
| Dual-lug Terminal | 4 AWG-250 MCM CU/AL | 8 mm hex wrench 5/8-18 UNF Hex screw | 1 in. (upper) 2 in. (lower) | 3/0 AWG-250 MCM 275 LB-IN 4 AWG-2/0 AWG 110 LB-IN |
| Single-lug Terminal | 4 AWG-250 MCM CU/AL | 8 mm hex wrench 5/8-18 UNF Hex screw | 1 in | 3/0 AWG-250 MCM 275LB-IN 4 AWG-2/0 AWG 110LB-IN |
| N bar | 4 AWG-250 MCM CU/AL | 8 mm hex wrench 5/8-18 UNF Hex screw | 1 in | 3/0 AWG-250 MCM 275 LB-IN 4 AWG-2/0 AWG 110 LB-IN |
| | 14 AWG-2/0 AWG CU/AL | 5 mm hex wrench 7/16-20 UNF Hex screw | 1 in. | 3 AWG-2/0 AWG 110 LB-IN 14 AWG-4 AWG 35 LB-IN |
| | 14 AWG-4 AWG CU/AL | Straight screwdriver 1/4-28 UNF | 0.6 in. | 14 AWG-4 AWG 26 LB-IN |
| G bar | 14 AWG-2/0 AWG CU/AL | 5mm hex wrench Hex screw: 7/16-20 UNF | 0.8 in. | 3 AWG-2/0 AWG 110 LB-IN 14 AWG-4 AWG 35 LB-IN |
| | 14 AWG-4 AWG CU/AL | Straight screwdriver 1/4-28 UNF | 0.4 in./0.8 in. | 14 AWG-4 AWG 26 LB-IN |

Appendix: Allowed Breakers

Table 1 Grid Breaker

| S/N | Model | Current | Description |
|-----|----------|---------|---|
| 1 | CSR2100 | 100 A | Eaton#Circuit Breaker; 2-Pole, 25 kAIC, 100 A/240 V |
| 2 | CSR2125N | 125 A | Eaton#Circuit Breaker; 2-Pole, 25 kAIC, 125 A/240 V |
| 3 | CSR2150N | 150 A | Eaton#Circuit Breaker; 2-Pole, 25 kAIC, 150 A/240 V |
| 4 | CSR2175N | 175 A | Eaton#Circuit Breaker; 2-Pole, 25 kAIC, 175 A/240 V |
| 5 | CSR2200N | 200 A | Eaton#Circuit Breaker; 2-Pole, 25 kAIC, 200 A/240 V |
| 6 | BW2100 | 100 A | Eaton#Circuit Breaker; 2-Pole, 10 kAIC, 100 A/240 V |
| 7 | BW2125 | 125 A | Eaton#Circuit Breaker; 2-Pole, 10 kAIC, 125 A/240 V |
| 8 | BW2150 | 150 A | Eaton#Circuit Breaker; 2-Pole, 10 kAIC, 150 A/240 V |
| 9 | BW2175 | 175 A | Eaton#Circuit Breaker; 2-Pole, 10 kAIC, 175 A/240 V |
| 10 | BW2200 | 200 A | Eaton#Circuit Breaker; 2-Pole, 10 kAIC, 200 A/240 V |
| 11 | BWH2100N | 100 A | Eaton#Circuit Breaker; 2-Pole, 25 kAIC, 100 A/240 V |
| 12 | BWH2125N | 125 A | Eaton#Circuit Breaker; 2-Pole, 25 kAIC, 125 A/240 V |
| 13 | BWH2150N | 150 A | Eaton#Circuit Breaker; 2-Pole, 25 kAIC, 150 A/240 V |
| 14 | BWH2175N | 175 A | Eaton#Circuit Breaker; 2-Pole, 25 kAIC, 175 A/240 V |
| 15 | BWH2200N | 200 A | Eaton#Circuit Breaker; 2-Pole, 25 kAIC, 200 A/240 V |

Table 2 Backup Panel Breaker

| S/N | Model | Current | Description |
|-----|----------|---------|---|
| 1 | CSR2100 | 100 A | Eaton#Circuit Breaker; 2-Pole, 25 kAIC, 100 A/240 V |
| 2 | CSR2125N | 125 A | Eaton#Circuit Breaker; 2-Pole, 25 kAIC, 125 A/240 V |
| 3 | CSR2150N | 150 A | Eaton#Circuit Breaker; 2-Pole, 25 kAIC, 150 A/240 V |
| 4 | CSR2175N | 175 A | Eaton#Circuit Breaker; 2-Pole, 25 kAIC, 175 A/240 V |
| 5 | CSR2200N | 200 A | Eaton#Circuit Breaker; 2-Pole, 25 kAIC, 200 A/240 V |
| 6 | BW2100 | 100 A | Eaton#Circuit Breaker; 2-Pole, 10 kAIC, 100 A/240 V |
| 7 | BW2125 | 125 A | Eaton#Circuit Breaker; 2-Pole, 10 kAIC, 125 A/240 V |
| 8 | BW2150 | 150 A | Eaton#Circuit Breaker; 2-Pole, 10 kAIC, 150 A/240 V |
| 9 | BW2175 | 175 A | Eaton#Circuit Breaker; 2-Pole, 10 kAIC, 175 A/240 V |
| 10 | BW2200 | 200 A | Eaton#Circuit Breaker; 2-Pole, 10 kAIC, 200 A/240 V |
| 11 | BWH2100N | 100 A | Eaton#Circuit Breaker; 2-Pole, 25 kAIC, 100 A/240 V |
| 12 | BWH2125N | 125 A | Eaton#Circuit Breaker; 2-Pole, 25 kAIC, 125 A/240 V |
| 13 | BWH2150N | 150 A | Eaton#Circuit Breaker; 2-Pole, 25 kAIC, 150 A/240 V |

| S/N | Model | Current | Description |
|-----|----------|---------|---|
| 14 | BWH2175N | 175 A | Eaton#Circuit Breaker; 2-Pole, 25 kAIC, 175 A/240 V |
| 15 | BWH2200N | 200 A | Eaton#Circuit Breaker; 2-Pole, 25 kAIC, 200 A/240 V |

Table 3 Generator Breaker

| S/N | Model | Current | Description |
|-----|----------|---------|---|
| 1 | CSR2100 | 100 A | Eaton#Circuit Breaker; 2-Pole, 25 kAIC, 100 A/240 V |
| 2 | CSR2125N | 125 A | Eaton#Circuit Breaker; 2-Pole, 25 kAIC, 125 A/240 V |
| 3 | CSR2150N | 150 A | Eaton#Circuit Breaker; 2-Pole, 25 kAIC, 150 A/240 V |
| 4 | CSR2175N | 175 A | Eaton#Circuit Breaker; 2-Pole, 25 kAIC, 175 A/240 V |
| 5 | CSR2200N | 200 A | Eaton#Circuit Breaker; 2-Pole, 25 kAIC, 200 A/240 V |
| 6 | BW2100 | 100 A | Eaton#Circuit Breaker; 2-Pole, 10 kAIC, 100 A/240 V |
| 7 | BW2125 | 125 A | Eaton#Circuit Breaker; 2-Pole, 10 kAIC, 125 A/240 V |
| 8 | BW2150 | 150 A | Eaton#Circuit Breaker; 2-Pole, 10 kAIC, 150 A/240 V |
| 9 | BW2175 | 175 A | Eaton#Circuit Breaker; 2-Pole, 10 kAIC, 175 A/240 V |
| 10 | BW2200 | 200 A | Eaton#Circuit Breaker; 2-Pole, 10 kAIC, 200 A/240 V |
| 11 | BWH2100N | 100 A | Eaton#Circuit Breaker; 2-Pole, 25 kAIC, 100 A/240 V |
| 12 | BWH2125N | 125 A | Eaton#Circuit Breaker; 2-Pole, 25 kAIC, 125 A/240 V |
| 13 | BWH2150N | 150 A | Eaton#Circuit Breaker; 2-Pole, 25 kAIC, 150 A/240 V |
| 14 | BWH2175N | 175 A | Eaton#Circuit Breaker; 2-Pole, 25 kAIC, 175 A/240 V |
| 15 | BWH2200N | 200 A | Eaton#Circuit Breaker; 2-Pole, 25 kAIC, 200 A/240 V |

Table 4 Solar Breaker

| S/N | Description | Manufacturer Model 1 | Manufacturer Model 2 | Manufacturer Model 3 |
|-----|-----------------------------|----------------------|----------------------|----------------------|
| 1 | 2-Pole, 10 kAIC, 30 A/240 V | Eaton# BR230 | Siemens# Q230 | Schneider# HOM230 |
| 2 | 2-Pole, 10 kAIC, 40 A/240 V | Eaton# BR240 | Siemens# Q240 | Schneider# HOM240 |
| 3 | 2-Pole, 10 kAIC, 50 A/240 V | Eaton# BR250 | Siemens# Q250 | Schneider# HOM250 |
| 4 | 2-Pole, 10 kAIC, 60 A/240 V | Eaton# BR260 | Siemens# Q260 | Schneider# HOM260 |
| 5 | 2-Pole, 10 kAIC, 70 A/240 V | Eaton# BR270 | Siemens# Q270 | Schneider# HOM270 |
| 6 | 2-Pole, 10 kAIC, 80 A/240 V | Eaton# BR280 | Siemens# Q280 | Schneider# HOM280 |
| 7 | 2-Pole, 22 kAIC, 30 A/240 V | Eaton# BRH230 | Siemens# Q230H | N/A |
| 8 | 2-Pole, 22 kAIC, 40 A/240 V | Eaton# BRH240 | Siemens# Q240H | N/A |
| 9 | 2-Pole, 22 kAIC, 50 A/240 V | Eaton# BRH250 | Siemens# Q250H | N/A |
| 10 | 2-Pole, 22 kAIC, 60 A/240 V | Eaton# BRH260 | Siemens# Q260H | N/A |
| 11 | 2-Pole, 22 kAIC, 70 A/240 V | Eaton# BRH270 | Siemens# Q270H | N/A |
| 12 | 2-Pole, 22 kAIC, 80 A/240 V | Eaton# BRH280 | Siemens# Q280H | N/A |

Table 5 aPower Breaker

| S/N | Description | Manufacturer Model 1 | Manufacturer Model 2 | Manufacturer Model 3 |
|-----|------------------------------|----------------------|----------------------|----------------------|
| 1 | 2-Pole, 10 kAIC, 30A/240 V | Eaton# BR230 | Siemens# Q230 | Schneider# HOM230 |
| 2 | 2-Pole, 10 kAIC, 40 A/240 V | Eaton# BR240 | Siemens# Q240 | Schneider# HOM240 |
| 3 | 2-Pole, 10 kAIC, 50 A/240 V | Eaton# BR250 | Siemens# Q250 | Schneider# HOM250 |
| 4 | 2-Pole, 10 kAIC, 60 A/240 V | Eaton# BR260 | Siemens# Q260 | Schneider# HOM260 |
| 5 | 2-Pole, 10 kAIC, 70 A/240 V | Eaton# BR270 | Siemens# Q270 | Schneider# HOM270 |
| 6 | 2-Pole, 10 kAIC, 80 A/240 V | Eaton# BR280 | Siemens# Q280 | Schneider# HOM280 |
| 7 | 2-Pole, 10 kAIC, 90 A/240 V | Eaton# BR290 | Siemens# Q290 | Schneider# HOM290 |
| 8 | 2-Pole, 10 kAIC, 100 A/240 V | Eaton# BR2100 | Siemens# Q2100 | Schneider# HOM2100 |
| 9 | 2-Pole, 22 kAIC, 30 A/240 V | Eaton# BRH230 | Siemens# Q230H | N/A |
| 10 | 2-Pole, 22 kAIC, 40 A/240 V | Eaton# BRH240 | Siemens# Q240H | N/A |
| 11 | 2-Pole, 22 kAIC, 50 A/240 V | Eaton# BRH250 | Siemens# Q250H | N/A |
| 12 | 2-Pole, 22 kAIC, 60 A/240 V | Eaton# BRH260 | Siemens# Q260H | N/A |
| 13 | 2-Pole, 22 kAIC, 70 A/240 V | Eaton# BRH270 | Siemens# Q270H | N/A |
| 14 | 2-Pole, 22 kAIC, 80 A/240 V | Eaton# BRH280 | Siemens# Q280H | N/A |
| 15 | 2-Pole, 22 kAIC, 90 A/240 V | Eaton# BRH290 | Siemens# Q290H | N/A |
| 16 | 2-Pole, 22 kAIC, 100 A/240 V | Eaton# BRH2100 | Siemens# Q2100H | N/A |

Table 6 Smart Circuits Breaker

| Breaker for Smart Circuit 1 and 2 (1-Pole) | | | |
|--|--------|---------|--|
| S/N | Model | Current | Description |
| 1 | CH120 | 20 A | Eaton#Circuit Breaker; 1-Pole, 10 kAIC, 20 A/240 V |
| 2 | CH130 | 30 A | Eaton#Circuit Breaker; 1-Pole, 10 kAIC, 30 A/240 V |
| 3 | CH135 | 35 A | Eaton#Circuit Breaker; 1-Pole, 10 kAIC, 35 A/240 V |
| 4 | CH140 | 40 A | Eaton#Circuit Breaker; 1-Pole, 10 kAIC, 40 A/240 V |
| 5 | CH145 | 45 A | Eaton#Circuit Breaker; 1-Pole, 10 kAIC, 45 A/240 V |
| 6 | CH150 | 50 A | Eaton#Circuit Breaker; 1-Pole, 10 kAIC, 50 A/240 V |
| 7 | CHF130 | 30 A | Eaton#Circuit Breaker; 1-Pole, 10 kAIC, 30 A/240 V |
| 8 | CHF135 | 35 A | Eaton#Circuit Breaker; 1-Pole, 10 kAIC, 35 A/240 V |
| 9 | CHF140 | 40 A | Eaton#Circuit Breaker; 1-Pole, 10 kAIC, 40 A/240 V |
| 10 | CHF145 | 45 A | Eaton#Circuit Breaker; 1-Pole, 10 kAIC, 45 A/240 V |
| 11 | CHF150 | 50 A | Eaton # Circuit Breaker; 1-Pole, 10 kAIC, 50 A/240 V |
| Breaker for Smart Circuit 1 + Circuit 2 (2-Pole) | | | |
| S/N | Model | Current | Description |
| 1 | CH230 | 30 A | Eaton#Circuit Breaker; 2-Pole, 10 kAIC, 30 A/240 V |
| 2 | CH235 | 35 A | Eaton#Circuit Breaker; 2-Pole, 10 kAIC, 35 A/240 V |
| 3 | CH240 | 40 A | Eaton#Circuit Breaker; 2-Pole, 10 kAIC, 40 A/240 V |
| 4 | CH245 | 45 A | Eaton#Circuit Breaker; 2-Pole, 10 kAIC, 45 A/240 V |
| 5 | CH250 | 50 A | Eaton#Circuit Breaker; 2-Pole, 10 kAIC, 50 A/240 V |
| 6 | CHF230 | 30 A | Eaton#Circuit Breaker; 2-Pole, 10 kAIC, 30 A/240 V |
| 7 | CHF235 | 35 A | Eaton#Circuit Breaker; 2-Pole, 10 kAIC, 35 A/240 V |
| 8 | CHF240 | 40 A | Eaton#Circuit Breaker; 2-Pole, 10 kAIC, 40 A/240 V |
| 9 | CHF245 | 45 A | Eaton#Circuit Breaker; 2-Pole, 10 kAIC, 45 A/240 V |
| 10 | CHF250 | 50 A | Eaton#Circuit Breaker; 2-Pole, 10 kAIC, 50 A/240 V |
| Breaker for Smart Circuit 3 | | | |
| S/N | Model | Current | Description |
| 1 | CH230 | 30 A | Eaton#Circuit Breaker; 2-Pole, 10 kAIC, 30 A/240 V |
| 2 | CH235 | 35 A | Eaton#Circuit Breaker; 2-Pole, 10 kAIC, 35 A/240 V |
| 3 | CH240 | 40 A | Eaton#Circuit Breaker; 2-Pole, 10 kAIC, 40 A/240 V |
| 4 | CH245 | 45 A | Eaton#Circuit Breaker; 2-Pole, 10 kAIC, 45 A/240 V |
| 5 | CH250 | 50 A | Eaton#Circuit Breaker; 2-Pole, 10 kAIC, 50 A/240 V |
| 6 | CH260 | 60 A | Eaton#Circuit Breaker; 2-Pole, 10 kAIC, 60 A/240 V |
| 7 | CH270 | 70 A | Eaton#Circuit Breaker; 2-Pole, 10 kAIC, 70 A/240 V |
| 8 | CH280 | 80 A | Eaton#Circuit Breaker; 2-Pole, 10 kAIC, 80 A/240 V |
| 9 | CHF230 | 30 A | Eaton#Circuit Breaker; 2-Pole, 10 kAIC, 30 A/240 V |
| 10 | CHF235 | 35 A | Eaton#Circuit Breaker; 2-Pole, 10 kAIC, 35 A/240 V |
| 11 | CHF240 | 40 A | Eaton#Circuit Breaker; 2-Pole, 10 kAIC, 40 A/240 V |
| 12 | CHF245 | 45 A | Eaton#Circuit Breaker; 2-Pole, 10 kAIC, 45 A/240 V |
| 13 | CHF250 | 50 A | Eaton#Circuit Breaker; 2-Pole, 10 kAIC, 50 A/240 V |

Table 7 Breaker in a combiner box

| S/N | Max. Current | Description |
|-----|--------------|--|
| 1 | 30 A | Circuit Breaker; 2-Pole, 10 kAIC, 30 A/240 V |
| 2 | 30 A | Circuit Breaker; 2-Pole, 22 kAIC, 30 A/240 V |