

Contents

Important safety information	5
Read this first	5
Product labels.....	5
Safety and advisory symbols.....	5
PV Rapid Shutdown Equipment (PVRSE)	9
1 The Enphase IQ System	10
1.1 How the Enphase IQ Series Microinverters work	11
System monitoring.....	11
2 Planning for microinverter installation	12
2.1 Compatibility	12
2.2 Grounding considerations	12
2.3 Branch circuit capacity	13
2.4 Utility service requirements	13
2.5 Wire lengths and voltage rise	13
2.6 Lightning and surge suppression	14
2.7 Parts and tools required	14
Enphase Equipment	14
Other Items.....	14
3 Enphase microinverter Installation	15
Step 1: Position the IQ Cable.....	16
Step 2: Position the junction box	17
Step 3: Mount the microinverters	18
Step 4: Create an installation map.....	19
Step 5: Manage the cabling	20
Step 6: Connect the microinverters	20
Step 7: Terminate the unused end of the cable.....	21
Step 8: Complete the installation of the junction box	22
Step 9: Connect the PV modules	22
Step 10: Energize the system	23
3.1 Set up and activate monitoring	23
4 Troubleshooting	24
4.1 Status LED indications and error reporting	24
4.1.1 LED operation	24
4.1.2 DC Resistance Low – Power Off Condition.....	24
4.1.3 Other faults	25

4.2	Troubleshoot an inoperable microinverter	26
4.3	Disconnect a microinverter	27
4.4	Install a replacement microinverter	28
4.5	Ordering replacement parts	29
4.6	IQ Cable planning and ordering	29
4.7	Connector spacing options	29
4.8	Cabling options	30
4.9	IQ Cable accessories	30
5	Technical data	31
5.1	Technical considerations	31
5.1.1	Module requirements.....	31
5.1.2	Bifacial modules	31
5.2	Specifications	32
5.2.1	IQ7-60-2-US Microinverter specifications.....	32
5.2.2	IQ7PLUS-72-2-US Microinverter specifications.....	35
5.2.3	IQ7X-96-2-US Microinverter specifications.....	37
5.2.4	IQ7A-72-2-US Microinverter specifications	39
5.2.5	IQ Cable specifications.....	42
5.2.6	Enphase connector ratings	42
5.3	Enphase installation map	43
	Sample wiring diagram	44
	Revision history	45

Corporate headquarters contact information

Enphase Energy Inc.

47281 Bayside Pkwy, Fremont, Ca 94538, United States, Ph: +1 (707)-763-4784

<https://enphase.com/contact/support>

FCC compliance

This equipment has been tested and found to comply with the limits for a Class B digital device, pursuant to part 15 of the FCC Rules. These limits are designed to provide reasonable protection against harmful interference in a residential installation. This equipment generates, uses, and can radiate radio frequency energy and, if not installed and used in accordance with the instructions, may cause harmful interference to radio communications. However, there is no guarantee that interference will not occur in a particular installation. If this equipment does cause harmful interference to radio or television reception, which can be determined by turning the equipment off and on, you are encouraged to try to correct the interference by one or more of the following measures:

- Reorient or relocate the receiving antenna.
- Increase the separation between the equipment and the receiver.
- Connect the equipment to an outlet on a circuit different from that to which the receiver is connected.
- Consult the dealer or an experienced radio/TV technician for help.

Changes or modifications not expressly approved by the party responsible for compliance may void the user's authority to operate the equipment.

Other information

Product information is subject to change without notice. All trademarks are recognized as the property of their respective owners.

User documentation is updated frequently; Check the Enphase website (enphase.com/support) for the latest information.

To ensure optimal reliability and to meet warranty requirements, the Enphase microinverter must be installed according to the instructions in this manual. For warranty text, refer to enphase.com/warranty.

For Enphase patent information, refer to enphase.com/company/patents/.

© 2023 Enphase Energy. All rights reserved. Enphase, the e and CC logos, IQ, and certain other marks listed at <https://enphase.com/trademark-usage-guidelines> are trademarks of Enphase Energy, Inc. in the US and other countries. Data subject to change.

Audience

This manual is intended for use by professional installation and maintenance personnel.

Important safety information

Read this first

This manual contains important instructions for use during the installation and maintenance of the IQ7 Series Microinverters.

IMPORTANT: Enphase IQ7 Series Microinverters listed in this manual require the IQ Cable. An IQ Gateway is required to monitor the performance and, where required, provide control of the IQ7 Series Microinverters.

Product labels

The following symbols appear on the **product label** and are described here:



WARNING: Hot surface



DANGER: Refer to safety instructions



DANGER: Risk of electric shock







Refer to manual



Double insulated

Safety and advisory symbols

To reduce the risk of electric shock, and to ensure the safe installation and operation of the IQ7 Series Microinverters System, the following safety symbols appear throughout this document to indicate dangerous conditions and important safety instructions.

	DANGER:	This indicates a hazardous situation, which, if not avoided, will result in death or serious injury.
	WARNING:	This indicates a situation where failure to follow instructions may be a safety hazard or cause equipment malfunction. Use extreme caution and follow instructions carefully.
	WARNING:	This indicates a situation where failure to follow instructions may result in burn injury.
	NOTE:	This indicates information that is very important for optimal system operation. Follow instructions closely.

IQ7 Series Microinverters safety instructions

General safety



DANGER: Risk of electric shock. Risk of fire.

Only use electrical system components approved for wet locations.

Only competent personnel should install, troubleshoot, or replace Enphase microinverters or IQ Cable and accessories.

Ensure that all AC and DC wiring is correct and that none of the AC or DC cables are pinched, shorted, or damaged. Ensure that all AC junction boxes are properly closed.

Do not exceed the maximum number of microinverters in an AC branch circuit as listed in the manual. You must protect each microinverter AC branch circuit with a 20 A maximum breaker or fuse as appropriate.



DANGER: Risk of electric shock.

Do not use Enphase equipment in a manner not specified by the manufacturer. Doing so may cause death or injury to persons, or damage to equipment.

Be aware that installation of this equipment includes the risk of electric shock.

The DC conductors of this photovoltaic system are ungrounded and may be energized.

Always de-energize the AC branch circuit before servicing. Never disconnect the DC or AC connectors under load.



WARNING:

Before installing or using the Enphase microinverter, read all instructions and cautionary markings in the technical description, on the Enphase equipment, and on the photovoltaic (PV) equipment.

Do not connect Enphase microinverters to the grid or energize the AC circuit(s) until you have completed all the installation procedures and have received approval from the electrical network operator.

When the PV array is exposed to light, DC voltage is supplied to the power conversion equipment (PCE).

Risk of equipment damage. Enphase male and female connectors must only be mated with the identical type and brand of male/female connector.



NOTE:

To ensure optimal reliability and to meet warranty requirements, install the Enphase equipment according to the instructions in this manual.

The AC and DC connectors on the cabling are rated as a disconnect only when used with an Enphase microinverter.

Protection against lightning and resulting voltage surge must be in accordance with local electrical codes and standards.

Perform all electrical installations in accordance with all applicable local electrical codes and standards.

Microinverter safety









WARNING: Risk of skin burn.

The chassis of the Enphase microinverter is the heat sink. Under normal operating conditions, the temperature could be 20°C above ambient temperature, but under extreme conditions, the microinverter can reach a temperature of 90°C. To reduce the risk of burns, use caution when working with microinverters.





DANGER: Risk of fire.

The DC conductors of the PV module must be labeled “PV Wire” or “PV Cable” when paired with the Enphase microinverter.

	<p>DANGER: Risk of electric shock. Risk of fire.</p>	<p>Only competent personnel may connect the Enphase microinverter to the electricity grid.</p>
		<p>Do not attempt to repair the Enphase microinverter; it contains no user-serviceable parts. If it fails, contact Enphase Support to obtain a return merchandise authorization (RMA) number and start the replacement process. Tampering with or opening the Enphase microinverter will void the warranty.</p>
	<p>WARNING: Risk of equipment damage.</p>	<p>Install the microinverter under the PV module to avoid direct exposure to rain, UV, and other harmful weather events. Always install the microinverter bracket side up. Do not mount the microinverter upside down. Do not expose the AC or DC connectors (on the IQ Cable, PV module, or microinverter) to rain or condensation before the connectors are mated.</p>
		<p>The maximum open circuit voltage of the PV module must not exceed the specified maximum input DC voltage of the Enphase microinverter. Refer to the Enphase Compatibility Calculator to verify PV module electrical compatibility with the microinverter. Use IQ8 Series Microinverters only with compatible PV modules as per the Enphase Compatibility Calculator. Using an electrically incompatible PV module voids Enphase warranty.</p>
	<p>WARNING: Risk of equipment damage.</p>	<p>You must match the DC operating voltage range of the PV module with the allowable input voltage range of the Enphase microinverter.</p> <p>The Enphase microinverter is not protected from damage due to moisture trapped in cabling systems. Never mate microinverters to cables that have been left disconnected and exposed to wet conditions. This voids the Enphase warranty.</p>
	<p>WARNING: Risk of equipment damage.</p>	<p>The Enphase microinverter functions only with a standard, compatible PV module with appropriate fill-factor, voltage, and current ratings. Unsupported devices include smart PV modules, fuel cells, wind or water turbines, DC generators, non-Enphase batteries, etc. These devices do not behave like standard PV modules, so operation and compliance are not guaranteed. These devices may also damage the Enphase microinverter by exceeding its electrical rating, making the system potentially unsafe.</p>
	<p>NOTE:</p>	<p>The Enphase microinverter has field-adjustable voltage and frequency trip points that may need to be set, depending upon local requirements. Only a competent authorized installer with the permission and following requirements of the local electrical authorities should make adjustments.</p>
	<p>NOTE:</p>	<p>Installers must check the manufacturing date of the products to ensure that the installation date is within one year of the manufactured date of the products. Contact your local distributor to validate the date code.</p>

IQ Cable safety

	<p>DANGER: Risk of electric shock.</p>	<p>Do not install the IQ Terminator while the power is connected.</p>
	<p>WARNING: Risk of electric shock. Risk of fire.</p>	<p>When stripping the sheath from the IQ Cable, ensure the conductors are not damaged. If the exposed wires are damaged, the system may not function properly.</p>
		<p>Do not leave AC connectors on the IQ Cable uncovered for an extended period. You must cover any unused connector with a sealing cap.</p>

Ensure protective sealing caps have been installed on all the unused AC connectors. Unused AC connectors are live when the system is energized.

**WARNING:**

Use the terminator only once. If you open the terminator following installation, the latching mechanism is destroyed. If the latching mechanism is defective, do not use the terminator. Do not circumvent or manipulate the latching mechanism.

Secure any loose cable when installing the IQ Cable to minimize tripping hazards.

**NOTE:**

When looping the IQ Cable, do not form loops smaller than 4.75" (12 cm) in diameter.

Provide support for the IQ Cable every 1.8 m (6 feet).

If you need to remove a sealing cap, you must use the IQ Disconnect Tool.

When installing the IQ Cable and accessories, adhere to the following:

- Do not expose the terminator cap or cable connections to directed, pressurized liquid (water jets, and so on).
 - Do not expose the terminator or cable to continuous immersion.
 - Do not expose the terminator cap or cable connections to continuous tension (for example, tension due to pulling or bending the cable near the connection).
 - Use only the connectors provided.
 - Do not allow contamination or debris in the connectors.
 - Use the terminator cap and cable connections only when all parts are present and intact.
 - Do not install or use in potentially explosive environments.
 - Do not allow the terminator to come into contact with an open flame.
 - Fit the terminator cap using only the prescribed tools and in the prescribed manner.
 - Use the terminator to seal the conductor end of the IQ Cable; no other method is allowed.
-

PV Rapid Shutdown Equipment (PVRSE)

This product is UL Listed as PV Rapid Shut Down Equipment and conforms with NEC-2014 and NEC-2017 section 690.12 and C22.1-2015 Rule 64-218 Rapid Shutdown of PV Systems, for AC and DC conductors, when installed according to the following requirements:

- Microinverters and all DC connections must be installed inside the array boundary. Enphase further requires installing the microinverters and DC connections under the PV module to avoid direct exposure to rain, UV, and other harmful weather events.
- The array boundary is defined as 305 mm (1 ft) from the array in all directions or 1 m (3 ft) from the point of entry inside a building.

This rapid shutdown system must be provided with an initiating device and (or with) a status indicator, which must be installed in a location accessible to first responders, or it must be connected to an automatic system that initiates rapid shutdown upon the activation of a system disconnect or activation of another type of emergency system.

The initiator shall be listed and identified as a disconnecting means that indicates whether it is in the “off” or “on” position. Examples are:

- Service disconnecting means
- PV system disconnecting means
- Readily accessible switch or circuit breaker

The handle position of a switch or circuit breaker is suitable for use as an indicator. Refer to NEC or CSA C22.1-2015 for more information.

Additionally, in a prominent location near the initiator device, a placard or label must be provided with a permanent marking including the following wording:

‘PHOTOVOLTAIC SYSTEM EQUIPPED WITH RAPID SHUTDOWN’ The term ‘PHOTOVOLTAIC’ may be replaced with ‘PV.’ The placard, label, or directory shall be reflective, with all letters capitalized and having a minimum height of 9.5 mm (3/8”) in white on a red background.

1 The Enphase IQ System

The Enphase IQ System includes:

- **Enphase IQ7, IQ7+, IQ7A, and IQ7X Microinverters** The smart grid-ready IQ Series Microinverters convert the DC output of the PV module into grid-compliant AC power.
- **IQ Gateway (ENV-IQ-AM1-240)** The IQ Gateway is a communication device that provides network access to the PV array. The IQ Gateway collects production and performance data from the Enphase IQ Microinverters over on-site AC power lines and transmits the data to the Enphase App through an internet or cellular modem connection. The IQ Gateway can monitor up to 600 Enphase IQ Microinverters and up to 39 Enphase IQ Batteries. For details, refer to the *IQ Gateway Installation and Operations Manual*.



NOTE: All 208 VAC installations require that you use the IQ Gateway to commission the Enphase microinverters to propagate correct grid profile settings for 208 VAC trip points.

- **Enphase Installer Portal** web-based monitoring and management software. Installers can use the Enphase Installer Portal to view detailed performance data, manage multiple PV systems, and remotely resolve issues that might impact system performance. Find out more at <https://enphase.com/en-gb/installers/apps>.
- **Enphase Installer App** for iOS and Android devices. It allows installers to configure the system while onsite, eliminating the need for a laptop and improving installation efficiency. You can use the app to:
 - Connect to the IQ Gateway over a wireless network for faster system setup and verification.
 - View and email a summary report that confirms a successful installation.
 - Scan device serial numbers and sync system information with the Enphase Installer Portal.
- **IQ Cable Aggregator** Aggregates up to three fully populated 20 A branch circuits and supports solar arrays of up to 11.5 kW with a single rooftop aggregator.
- **IQ Battery**
- **IQ Field Wireable connectors (Q-CONN-10F and Q-CONN-10M)** Make connections from any IQ Cable or open IQ Field Wireable connector.

This manual describes the safe installation and operation of the Enphase microinverter.



NOTE: To ensure optimal reliability and to meet warranty requirements, the Enphase microinverter must be installed according to the instructions in this manual.

1.1 How the Enphase IQ Series Microinverters work

The Enphase microinverter maximizes energy production using a sophisticated maximum power point tracking (MPPT) algorithm. Each Enphase microinverter individually connects to one PV module in your array. This configuration enables an individual MPPT to control each PV module, ensuring that the maximum power available from each PV module is exported to the utility grid regardless of the performance of the other PV modules in the array. While an individual PV module in the array may be affected by shading, soiling, orientation, or PV module mismatch, each Enphase microinverter ensures top performance for its associated PV module.

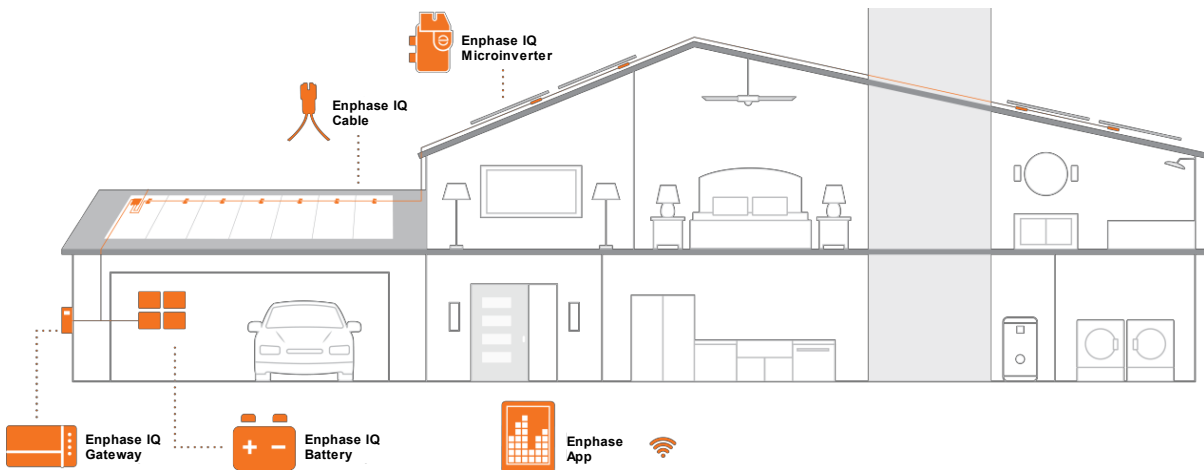

System monitoring

Once you install the IQ Gateway and provide an internet connection through a broadband router or modem, the Enphase IQ Microinverters automatically begin reporting to the Enphase App. The Enphase App presents current and historical system performance trends and PV system status.

Optimal reliability

Microinverter systems are inherently more reliable than traditional inverters. The distributed nature of a microinverter system ensures no single point of system failure in the PV system. Enphase microinverters are designed to operate at full power at ambient temperatures as high as 65°C (150°F).

Ease of design

PV systems using Enphase microinverters are very simple to design and install. You will not need string calculations or cumbersome traditional inverters. You can install individual PV modules in any combination of PV module quantity, type, age, and orientation. Each microinverter quickly mounts on the PV racking beneath each PV module. Low-voltage DC wires connect from the PV module directly to the co-located microinverter, eliminating the risk of personnel exposure to dangerously high DC voltage.

2 Planning for microinverter installation

The Enphase IQ7 Series Microinverters are compatible with PV modules, as listed in the following table. The microinverter housing is designed for outdoor installation and complies with the NEMA 250, type 6 environmental enclosure rating standard:



NEMA 6 rating definition: Indoor or outdoor use primarily to provide a degree of protection against hose-directed water, the entry of water during occasional temporary submersion at a limited depth, and damage from external ice formation.

The Enphase IQ Cable is available with connector spacing options to accommodate the installation of PV modules in portrait or landscape orientation. For IQ Cable ordering information, see [IQ Cable Planning and Ordering](#).

2.1 Compatibility

The Enphase IQ Series Microinverters are electrically compatible with PV modules, as listed in the following table. For specifications, see [Technical Data](#). You can refer to the [Enphase Compatibility Calculator](#) to verify PV module electrical compatibility. To ensure mechanical compatibility, be sure to order the correct connector type for both the microinverter and PV module from your distributor.



WARNING: Risk of fire. The PV module DC conductors must be labeled "PV Wire" or "PV Cable" to comply with NEC for Ungrounded PV Power Systems.

Microinverter model	Connector type	PV module* cell count
IQ7-60-2-US	MC-4 locking type	Pair only with 60-cell/120-half-cell
IQ7A-72-2-US	MC-4 locking type	Pair with 60-cell/120-half-cell and 72-cell/144-half-cell PV modules.
IQ7PLUS-72-2-US	MC-4 locking type	Pair with 60-cell/120-half-cell and 72-cell/144-half-cell PV modules
IQ7X-96-2-US	MC-4 locking type	Pair only with 96-cell modules

*Enphase IQ Series Microinverters are compatible with bifacial PV modules if the temperature-adjusted electrical parameters (maximum power, voltage, and current) of the modules, considering the front side electrical parameters (i.e., 0% back side gain), are within the allowable microinverter input parameters range. See [Technical Considerations](#) for more information.

2.2 Grounding considerations

The Enphase microinverter models listed in this guide do not require grounding electrode conductors (GEC), equipment grounding conductors (EGC), or grounded conductor (neutral). Your Authority Having Jurisdiction (AHJ) may require you to bond the mounting bracket to the racking. If so, use UL2703 hardware or star washers. The microinverter itself has a Class II double-insulated rating, which includes ground fault protection (GFP). To support GFP, use only PV modules equipped with DC cables labeled PV Wire or PV Cable.

2.3 Branch circuit capacity

Plan your AC branch circuits to meet the following limits for a maximum number of microinverters per branch when protected with a 20 A (maximum) over current protection device (OCPD).

Maximum* IQ7 Series Microinverters per AC branch circuit				
Breaker	IQ7	IQ7+	IQ7X	IQ7A
240 VAC	16	13	12	11
208 VAC	13	11	10	11

*Limits may vary. Refer to local requirements to define the number of microinverters per branch in your area.

2.4 Utility service requirements

The Enphase IQ Series Microinverters work with single-phase service. Measure AC line voltages at the electrical utility connection to confirm that it is within the range shown in the following table.

240 VAC, single phase	
L1 to L2	211 to 264 VAC
L1, L2 to ground	106 to 132 VAC
208 VAC, single phase	
L1 to L2	183 to 229 VAC
L1, L2 to ground	106 to 132 VAC



NOTE: All 208 VAC installations require that you use the IQ Gateway to commission the Enphase microinverters to propagate correct grid profile settings for 208 VAC trip points.

2.5 Wire lengths and voltage rise

Select the appropriate AC conductor size to minimize voltage rise when planning the system. Select the correct wire size based on the distance from the microinverter AC branch circuit's beginning to the load center breaker. Enphase recommends a voltage rise of less than 2% for the sections from the microinverter AC branch circuit to the breaker in the load center.

Enphase provides guidance about choosing wire size and maximum conductor lengths in the *Voltage Rise Technical Brief* at enphase.com/support. Refer to this brief for voltage rise values in IQ Cables and how to calculate voltage rise in other wire sections of the system.

Standard guidelines for voltage rise on feeder and AC branch circuit conductors might not be sufficient for microinverter AC branch circuits that contain the maximum allowable microinverters. This is due to the high inherent voltage rise on the AC branch circuit.



Best practice: Center-feed the branch circuit to minimize voltage rise in a fully-populated branch. This practice greatly reduces the voltage rise as compared with an end-fed branch. To center-feed a branch, divide the circuit into two sub-branch circuits protected by a single OCPD. Using the IQ Aggregator is a convenient way to do this.

2.6 Lightning and surge suppression

Enphase microinverters have integral surge protection, greater than most traditional inverters. However, if the surge has sufficient energy, the protection built into the microinverter can be exceeded, and the equipment can be damaged. For this reason, Enphase recommends that you protect your system with a lightning and/or surge suppression device. In addition to having some level of surge suppression, it is also important to have insurance that protects against lightning and electrical surges. Enphase has tested the following devices:

- [Leviton 51110-SRG](#)
- [Schneider SquareD HEPD50](#)



NOTE: Protection against lightning and resulting voltage surge must be in accordance with local standards.

2.7 Parts and tools required

In addition to the microinverters, PV modules, and racking, you will need the following:

Enphase Equipment

- **IQ Gateway:** Required to monitor production. IQ Gateway (model ENV-IQ-AM1-240) communications gateway or IQ Combiner (model X-IQ-AM1-240-B, X-IQ-AM1-240-2, X-IQ-AM1-240-3, X-IQ-AM1-240-3C).
- **Enphase Installer App:** Download the Enphase Installer App, open it, and log in to your Enphase account. Use it later to scan the microinverter serial numbers and connect to the IQ Gateway to track system installation progress. To download, go to <https://enphase.com/installers/apps> or scan the QR code.
- **Tie wraps or IQ Cable Clips** (Q-CLIP-100)
- **IQ Sealing Caps** (Q-SEAL-10) for any unused drops on the IQ Cable
- **IQ Terminator** (Q-TERM-10) typically two needed per branch circuit
- **IQ Disconnect Tool** (Q-DISC-10)
- **IQ Field Wireable Connectors** (male and female: Q-CONN-10M and Q-CONN-10F)
- **IQ Cable:**



Cable model	Connector spacing	PV module orientation	Connector count per box
Q-12-10-240	1.3 m	Portrait	240
Q-12-17-240	2.0 m	Landscape (60-cell)	240
Q-12-20-200	2.3 m	Landscape (72-cell)	200

Other Items

- AC junction box
- Terminal screwdrivers
- Wire cutters, voltmeter
- Torque wrench, sockets, and wrenches for mounting hardware

3 Enphase microinverter Installation

Installing the Enphase IQ Series Microinverters involves several key steps. Each step listed here is detailed in the following pages.

- Step 1:** Position the IQ Cable
- Step 2:** Position the Enphase IQ Aggregator
- Step 3:** Mount the microinverters
- Step 4:** Create an installation map
- Step 5:** Manage the cabling
- Step 6:** Connect the microinverters
- Step 7:** Terminate the unused end of the cable
- Step 8:** Complete the installation of the junction box
- Step 9:** Connect the PV modules
- Step 10:** Energize the system

Horizontal mount

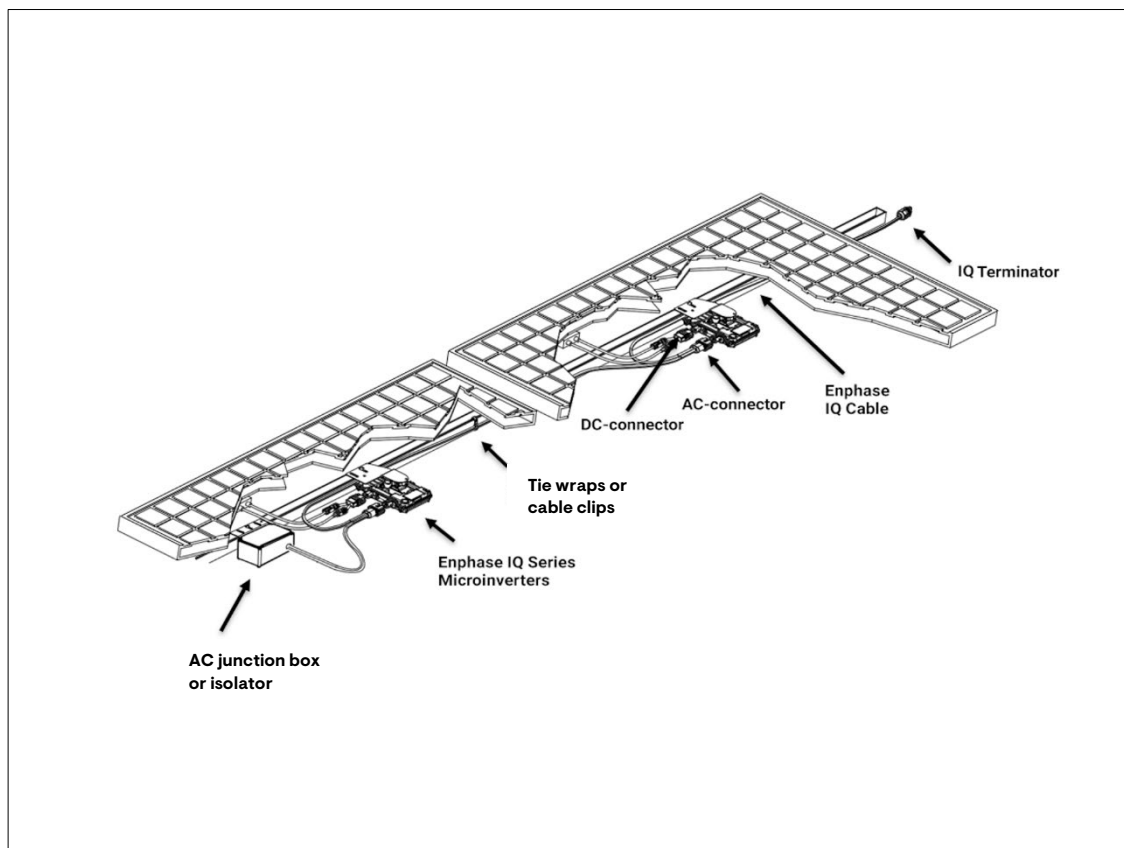

Vertical mount

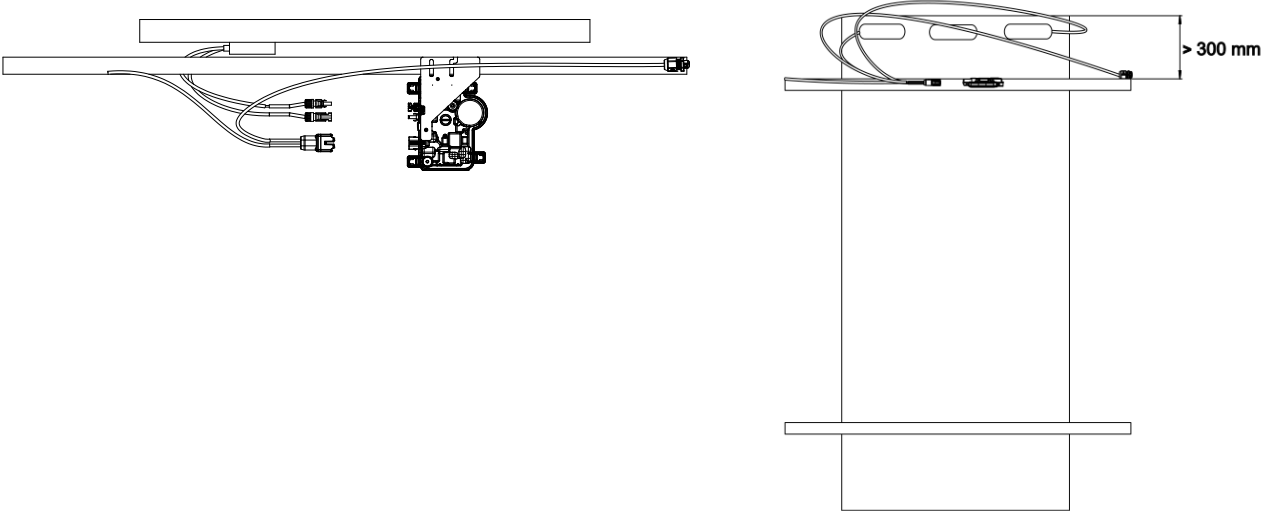

Step 1: Position the IQ Cable

- Plan each cable segment to allow drop connectors on the IQ Cable to align with each PV module. Allow extra length for slack, cable turns, and any obstructions.
- Mark the approximate centers of each PV module on the PV racking.
- Lay out the cabling along the installed racking for the AC branch circuit.
- Cut each segment of cable to meet your planned needs.



WARNING: When transitioning between rows, secure the cable to the rail to prevent cable damage or connector damage. Do not count on the connector to withstand tension.

Step 2: Position the junction box

- A. Verify that the AC voltage at the site is within range.

Service type and voltage: L1-L2	
240 VAC split-phase	211 to 264 VAC
208 VAC split-phase	183 to 229 VAC



NOTE: All 208 VAC installations require that you use the IQ Gateway to commission the Enphase microinverters to propagate correct grid profile settings for 208 VAC trip points.

The IQ7A Microinverter has the same power rating at 208 V L1-L2 as the IQ7+ Microinverters.

- B. Install an Enphase IQ Aggregator or junction box at a suitable location on the racking.
 C. Provide an AC connection from the junction box back to the electricity network using equipment and practices as required by local jurisdictions.

Step 3: Mount the microinverters

- A. Mount the microinverter horizontally, bracket side up or vertically.
- Always place the microinverter under the PV module, protected from direct exposure to rain, sun, and other harmful weather events. Allow a minimum of 1.9 cm (3/4") between the roof and the microinverter. Also, allow 1.3 cm (1/2") between the back of the PV module and the top of the microinverter.
 - For vertical mount, maintain > 30 cm (12") clearance from the edges of the PV module to protect the microinverter from direct exposure to rain, UV, and other harmful weather events.



WARNING: Install the microinverter under the PV module to avoid direct exposure to rain, UV, and other harmful weather events. Do not mount the microinverter upside down.

- B. Torque the microinverter fasteners as follows. Do not over-torque.
- 6 mm (1/4") mounting hardware: 5 N m (45 to 50 in-lbs.)
 - 8 mm (5/16") mounting hardware: 9 N m (80 to 85 in-lbs.)
 - When using UL 2703 mounting hardware, use the manufacturer's recommended torque value.

Horizontal mount

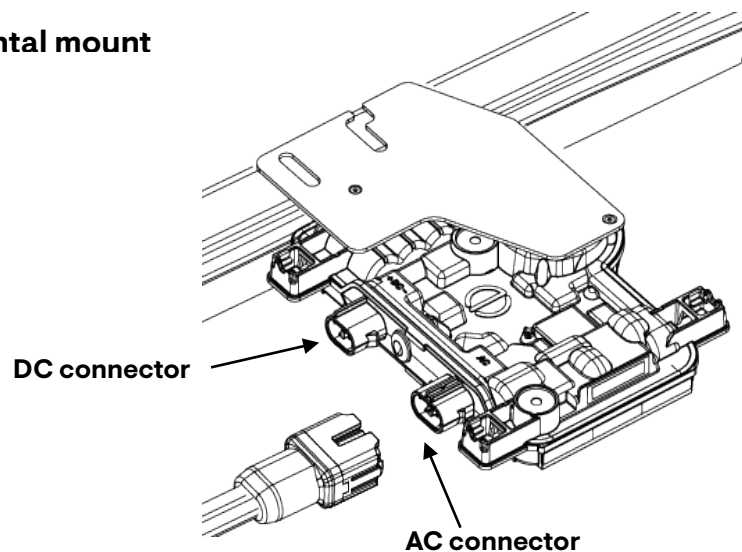

Vertical mount

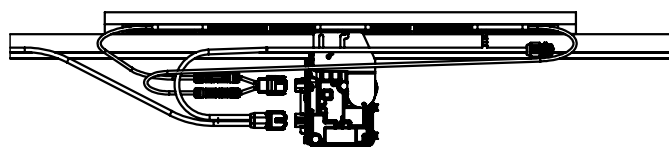

Step 4: Create an installation map

The Enphase installation map is a diagram of the physical location of each microinverter in your PV installation. Copy or use the blank map to record microinverter placement for the system or provide your own layout if you require a larger or more intricate installation map.

Each Enphase microinverter, IQ Gateway, and Battery has a removable serial number label. Build the installation map by peeling the serial number labels from the microinverter mounting plates and placing the labels on the map. You will also place the IQ Gateway and IQ Battery serial number on the map after installation.

After you have created the installation map, use the Enphase Installer App to record serial numbers and configure the system.

For details, refer to “Detect the Microinverters” in the help topics of the Enphase Installer App.

- A. Peel the removable serial number label from each microinverter and affix it to the respective location on the paper installation map.
- B. Peel the label from the IQ Gateway and any Enphase battery, if installed) and affix it to the installation map.
- C. Always keep a copy of the installation map for your records.

The image shows a blank Enphase installation map. It features a header section with fields for 'Panel Group', 'Azimuth', 'Tilt', 'Sheet ___ of ___', 'To Sheet: ↑', 'Customer information', and 'Installer information'. Below the header is a grid with 13 rows labeled A through M and 7 columns labeled 1 through 7. A compass rose in the top right corner indicates North, South, East, and West. At the bottom of the grid, there is a footer section containing the Enphase logo, the text 'INSTALLATION MAP', and a small box with the number '140-0003'. Below the footer, there is a note: 'Scan completed map and upload to the Activation page online at www.enphaseenergy.com. Use this map to build the virtual array in Enlighten Array Builder.' An arrow points from the text 'Affix serial number labels' to the grid area.

Affix serial number labels

Step 5: Manage the cabling

- A. Use cable clips or tie wraps to attach the cable to the racking. Leave no more than 1.8 m (six feet) between cable clips or tie wraps.
- B. Dress any excess cabling in loops so that it does not contact the roof. Do not form loops smaller than 12 cm (4¾ ") in diameter.

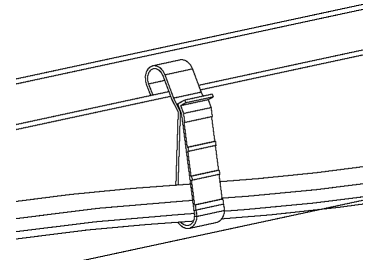

Cable clip



WARNING: Tripping Hazard. Loose cables can become a tripping hazard. Dress the IQ Cable to minimize this potential.

Step 6: Connect the microinverters

- A. Connect the microinverter. Listen for a click as the connectors engage.
- B. Cover any unused connector with Enphase Sealing Caps. Listen for a click as the connectors engage.



WARNING: Risk of electric shock. Risk of fire. Install sealing caps on all unused AC connectors, as these connectors become live when the system is energized. Sealing caps are required for protection against moisture ingress.

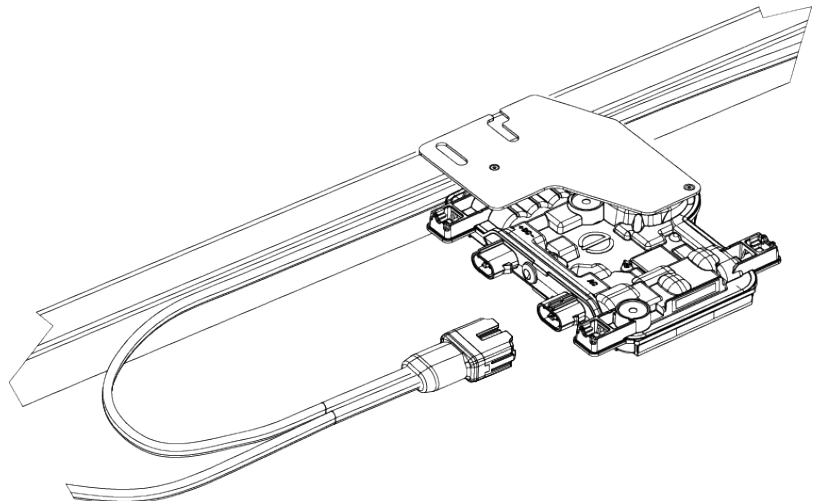

NOTE: If you need to remove a sealing cap, use the IQ Disconnect Tool. See [Disconnect a Microinverter](#) for more information.

Step 7: Terminate the unused end of the cable

Terminate the unused end of the IQ Cable as follows.

- A. Remove 13 mm (½ ") of the cable sheath from the conductors. Use the terminator loop to measure 13 mm.
- B. Slide the hex nut onto the cable.
- C. Insert the cable into the terminator body so that each of the two wires lands on opposite sides of the internal separator. There is a grommet inside of the hex nut that should remain in place.

Terminator Body **13mm**

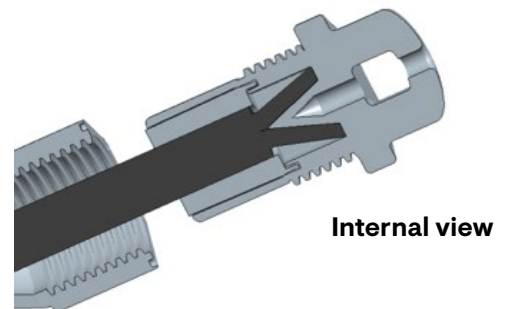
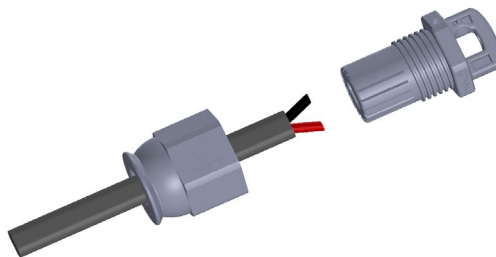
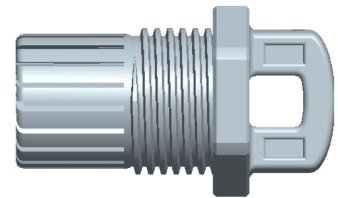

- D. Insert a screwdriver into the slot on the top of the terminator to hold it in place, and torque the nut to 7 N m.
- E. Hold the terminator body stationary with the screwdriver and turn only the hex nut to prevent the conductors from twisting out of the separator.



NOTE: Turn only the hex nut to prevent conductors from twisting out of the separator.

- F. Attach the terminated cable end to the PV racking with a cable clip or tie wrap so that the cable and terminator do not touch the roof.



WARNING: The terminator cannot be re-used. If you unscrew the nut, you must discard the terminator.

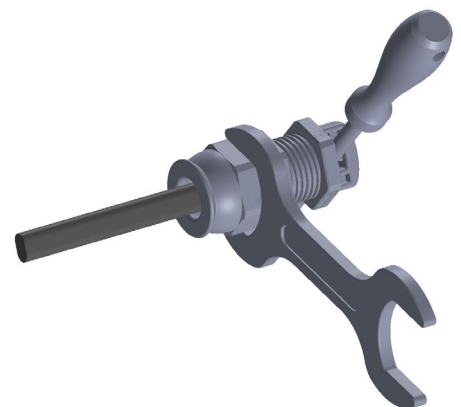

Step 8: Complete the installation of the junction box

- A. Connect the IQ Cable to the junction box.
- B. Use the ground lug on the IQ Aggregator for module, rack, and balance of system grounding, if needed.
- C. Refer to the [wiring diagrams](#) for more information. Wire colors are listed in the following table.

Wire colors
L1 – Black
L2 – Red

Step 9: Connect the PV modules



WARNING: Electrical shock hazard. The DC conductors of this photovoltaic system are ungrounded and may be energized.

- A. If required, attach the Enphase DC bulkhead adaptors to the microinverters. Ensure they are fully seated. Do not reverse the adaptor connections.
- B. Connect the DC leads of each PV module to the DC input connectors of the corresponding microinverter or adapter.
- C. Check the LED on the connector side of the microinverter. The LED flashes six times when the DC power is applied.
- D. Mount the PV modules above the microinverters.

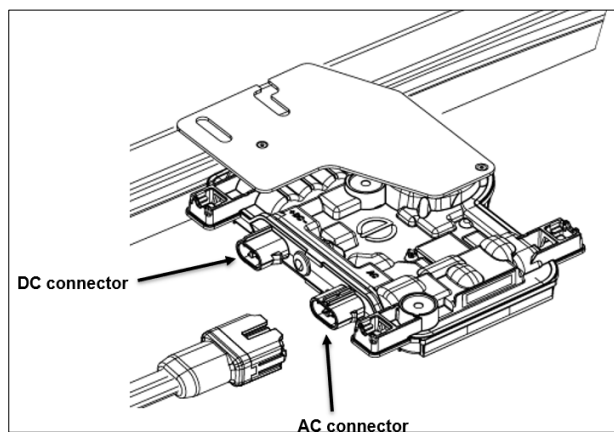

Step 10: Energize the system

- A. Turn ON the AC disconnect or circuit breaker for the branch circuit.
- B. Turn ON the main utility-grid AC circuit breaker. Your system starts producing power after a five-minute wait time.
- C. Check the LED on the connector side of the microinverter:

LED color	Indicates
Flashing green	Normal operation. AC grid function is normal, and there is communication with the IQ Gateway.
Flashing orange	The AC grid is normal, but there is no communication with the IQ Gateway.
Flashing red	The AC grid is either not present or not within specification.
Solid red	There is an active “DC Resistance Low, Power Off Condition.” To reset, see “ DC Resistance Low – Power Off Condition ”.

3.1 Set up and activate monitoring

Refer to the *IQ Gateway Quick Install Guide* to install the IQ Gateway and set up system monitoring and grid management functions. This guide leads you through the following:

- Connecting the IQ Gateway
- Detect devices
- Connecting to Enphase Installer App
- Registering the system
- Building the virtual array



NOTE: When the utility requires a profile other than the default IEEE 1547 (for example, grids managed by Hawaii Electric Industries [HEI], including HECO), you must select an appropriate grid profile for your installation. You can set the grid profile through the Enphase Installer App, during system registration, or through the Enphase Installer App at any time. You must have an IQ Gateway communications gateway to set or change the grid profile.

For more information on setting or changing the grid profile, refer to the *IQ Gateway Installation and Operation Manual* at enphase.com/support.

4 Troubleshooting

Follow all the safety measures described throughout this manual. Qualified personnel can use the following troubleshooting steps if the PV system does not operate correctly.



WARNING: Risk of electric shock. Do not attempt to repair the Enphase microinverter; it contains no user-serviceable parts. If it fails, contact Enphase support to obtain an RMA (return merchandise authorization) number and start the replacement process.

4.1 Status LED indications and error reporting

The following section describes LED indications.

4.1.1 LED operation

LED color	Indicates
Flashing green	Normal operation. AC grid function is normal; there is communication with the IQ Gateway.
Flashing orange	The AC grid is normal, but there is no communication with the IQ Gateway.
Flashing red	The AC grid is either not present or not within specification.
Solid red	There is an active “DC Resistance Low, Power Off Condition.” To reset, see DC Resistance Low – Power Off Condition .

The status LED on each microinverter glows green about six seconds after the DC power is applied. It remains lit solid for two minutes, followed by six green blinks. After that, red blinks indicate that no grid is present if the system is not yet energized.

Any short red blinks after the DC power is first applied to the microinverter indicate a failure during microinverter startup.

4.1.2 DC Resistance Low – Power Off Condition

For all IQ Series models, a solid red status LED when DC power has been cycled indicates the microinverter has detected a DC Resistance Low – Power Off event. The LED will remain red, and the fault will continue to be reported by the IQ Gateway until the error has been cleared.

An insulation resistance (IR) sensor in the microinverter measures the resistance between the positive and negative PV inputs to the ground. If either resistance drops below a threshold, the microinverter stops power production and raises this condition. This may indicate defective module insulation, defective wiring or connectors, moisture ingress, or a similar problem. Although the cause may be temporary, this microinverter condition persists until the sensor is manually reset.

An IQ Gateway is required to clear this condition. The condition clears on operator command unless its cause is still present.

If a microinverter registers a “DC Resistance Low - Power Off” condition, you can attempt to clear this condition. If the condition does not clear after you perform the following procedure, contact Enphase Support at enphase.com/en-us/support/contact.

There are two ways to send a clear message to the microinverter. Note that the condition will not clear after the sensor reset if the cause of the failure is still present. If the condition persists, contact your installer.



Method 1: Clear this error using the Enphase Installer App

- Log in to the Enphase Installer App and access the system.
- Click the **Events** tab. The next screen shows a current “DC Resistance Low - Power Off” condition for the system.
- Click **DC Resistance Low - Power Off**.
Where “n” is the number of affected devices, click **n devices (show details)**.
- Click the serial number of the affected microinverter.
- Click **Reset DC Resistance Low - Power Off Sensor**.

The system displays, “A DC Resistance Low- Power Off reset task was issued on [date and time] for this microinverter and is still pending.”

Method 2: Use the Enphase Installer App to clear the condition

On the list of detected microinverters, a green dot or red square appears to the left of each microinverter serial number. A green dot indicates Status OK. A red square indicates an event for that microinverter.

- Tap the  to the left of the serial number to view details for a microinverter event.
- If the microinverter status shows that there is an active **DC Resistance Low – Power Off** condition, tap the  to send the clear message to the affected microinverter.

The app then indicates that a clear message was sent.

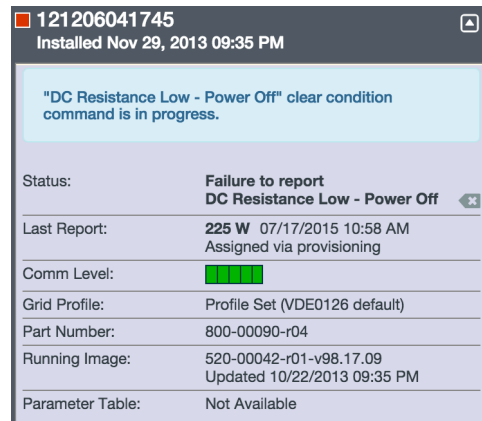
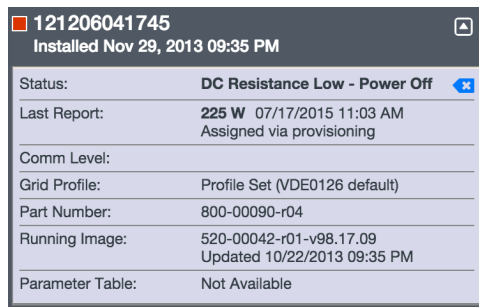

4.1.3 Other faults

All other faults are reported to the IQ Gateway. For troubleshooting procedures, refer to the *IQ Gateway Installation and Operation Manual* at enphase.com/support.

4.2 Troubleshoot an inoperable microinverter

To troubleshoot an inoperable microinverter, follow the steps in the order shown.



WARNING: Risk of electric shock. Always de-energize the AC branch circuit before servicing. Never disconnect the DC connectors under load.



WARNING: The Enphase microinverters are powered by DC power from the PV modules. Ensure you disconnect the DC connections and reconnect DC power, and then watch for the solid green about six seconds after connection to DC power.

- A. Ensure AC breakers and disconnects are closed.
- B. Check the connection to the utility grid and verify that the utility voltage is within allowable ranges.
- C. Verify that AC line voltages at all solar power circuit breakers at the load center and subpanels are within the ranges shown in the following table.
- D. Verify that the AC line voltage at the junction box for each AC branch circuit is within the ranges shown in the following table:

240 VAC, single phase	
L1 to L2	211 to 264 VAC
L1, L2 to ground	106 to 132 VAC
208 VAC, single phase	
L1 to L2	183 to 229 VAC
L1, L2 to ground	106 to 132 VAC

- E. Using an Enphase disconnect tool, disconnect the AC cable for the microinverter in question from the IQ Cable.
- F. Verify that utility power is present at the microinverter by measuring line to line and line to ground at the IQ Cable connector.
- G. Visually check that the AC branch circuit connections (IQ Cable and AC connections) are properly seated. Reseat if necessary. Check also for damage, such as rodent damage.
- H. Ensure that any upstream AC disconnects, as well as the dedicated circuit breakers for each AC branch circuit, are functioning properly and are closed.
- I. Using the Enphase disconnect tool, disconnect and re-connect the DC PV module connectors. The status LED of each microinverter will light solid green a few seconds after connection to DC power and then blink green six times to indicate normal start-up operation about two minutes after connecting to DC power. The LED subsequently resumes normal operation if the grid is present. See [LED operation](#) for normal LED operation.
- J. Attach an ammeter clamp to one conductor of the DC cables from the PV module to measure the microinverter current. This will be under one amp if the AC is disconnected.
- K. Verify the PV module DC voltage is within the allowable range shown in [Specifications](#).
- L. Swap DC leads with a known good, adjacent PV module. If, after checking the Enphase Installer Portal periodically (this may take up to 30 minutes), the problem moves to the adjacent module, this indicates that the PV module is not functioning correctly. If it stays in place, the problem is with the original microinverter. Contact [Enphase Support](#) for the microinverter data and for obtaining a replacement microinverter, if needed.

- M. Check the DC connections between the microinverter and the PV module. The connection may need to be tightened or reseated. If the connection is worn or damaged, it may need replacement.
- N. Verify with your utility that the line frequency is within the range.
- O. If the problem persists, contact Enphase Support at enphase.com/en-us/support/contact.

4.3 Disconnect a microinverter

If problems remain after following the troubleshooting steps listed previously, contact Enphase at enphase.com/en-us/support/contact. If Enphase authorizes a replacement, follow the steps below. To ensure the microinverter is not disconnected from the PV modules under load, follow the disconnection steps in the order shown:

- A. De-energize the AC branch circuit breaker.
- B. Enphase AC connectors are tool-removable only. To disconnect the microinverter from the IQ Cable, insert the disconnect tool and remove the connector.
- C. Cover the PV module with an opaque cover.
- D. Using a clamp-on meter, verify there is no current flowing in the DC wires between the PV module and the microinverter. If the current is still flowing, check that you have completed steps one and two above.



NOTE: Take care when measuring the DC, as most clamp-on meters must be zeroed first and tend to drift with time.

- E. Disconnect the PV module DC connectors from the microinverter using the disconnect tool from the manufacturer of the mating DC connector from the PV module connector.
- F. If present, loosen and/or remove any bonding hardware.
- G. Remove the microinverter from the PV racking.





WARNING: Risk of electric shock. Risk of fire. Do not leave any connectors on the PV system disconnected for an extended period. If you do not plan to replace the microinverter immediately, you must cover any unused connector with a sealing cap.

4.4 Install a replacement microinverter

- A. When the replacement microinverter is available, verify that the AC branch circuit breaker is de-energized.
- B. Mount the microinverter bracket side up and under the PV module, away from rain and sun. Allow a minimum of 1.9 cm (3/4") between the roof and the microinverter. Also, allow 1.3 cm (1/2") between the back of the PV module and the top of the microinverter. For vertical mount, maintain > 30 cm (12") clearance from the edges of the PV module to protect the microinverter from direct exposure to rain, UV, and other harmful weather events.



WARNING: Risk of equipment damage. Mount the microinverter under the PV module.

- Install the microinverter under the PV module to avoid direct exposure to rain, UV, and other harmful weather events.
 - Always install the microinverter bracket side up.
 - Do not mount the microinverter upside down.
 - Do not expose the AC or DC connectors (on the IQ Cable connection, PV module, or microinverter) to rain or condensation before the connectors are mated.
- C. Torque the mounting fasteners to the values shown. Do not over-torque.
 - 6 mm (1/4") mounting hardware: 5 N m (45 to 50 in-lbs.)
 - 8 mm (5/16") mounting hardware: 9 N m (80 to 85 in-lbs.)
 - When using UL 2703 mounting hardware, use the manufacturer's recommended torque value
 - D. If you are using bonding hardware, discard the old bonding hardware and use a new bonding hardware when installing the replacement microinverter.
 - E. Connect the microinverter to the connector. Listen for a click as connectors engage.
 - F. Connect the DC leads of each PV module to the DC input connector of the microinverter.
 - G. Re-mount the PV module above the microinverter.
 - H. Energize the AC branch circuit breaker and verify the operation of the replacement microinverter by checking the Status LED on the connector side of the microinverter.
 - I. Use the Enphase Installer App to delete the old microinverter serial number from the IQ Gateway database. In the Enphase Installer App, once connected to the IQ Gateway:
 - a. Tap **Microinverters > Manage**.
 - b. Tap the checkbox  to the right of the microinverter serial number replaced.
 - c. Tap  to delete the microinverter from the IQ Gateway database.
 - J. Add the new microinverter serial number to the IQ Gateway database by initiating a device scan using one of the following methods:
 - a. **Method 1: Initiate a scan using the Enphase Installer App**
 - In the Enphase Installer App, once connected to the IQ Gateway, navigate to the Overview screen.
 - From the Overview screen, tap **Detected > Start Device Scan** to start a new 30-minute device scan.
 - If device scanning on the IQ Gateway is inhibited, the app displays **Scan Inhibited**. If you need to add more microinverters to the system when device scanning is inhibited on the IQ Gateway, you must use the Enphase Installer App scanning tool to provision them on the IQ Gateway, rather than using the IQ Gateway's device scanning function to discover them. If this is not possible and

you need to enable device scanning on the IQ Gateway, contact Enphase Support at enphase.com/en-us/support/contact.

b. **Method 2: Use an IQ Gateway**

- Press the Device Scan button on the IQ Gateway. The IQ Gateway begins a 15-minute scan to identify all the microinverters deployed at the site. The Microinverter Communications LED flashes green during the scan.

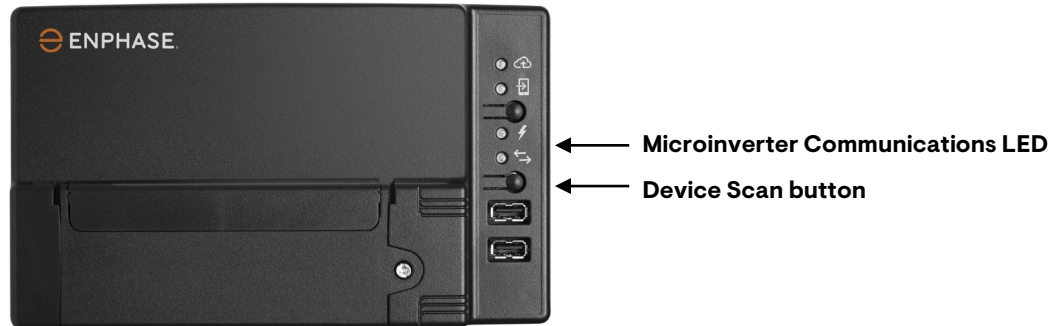

- K. Log in to Enphase App to use Enphase App's Array Builder to add the newly detected microinverter to the virtual array.
- L. Ship the old microinverter to Enphase using the supplied return shipping label.

4.5 Ordering replacement parts

Replacement adaptors for Microinverters with MC-4 DC connectors include:

- **Q-DCC-2:** Cable assembly, DC adaptor to MC-4
- **Q-DCC-5:** Cable assembly, DC adaptor to Amphenol UTX

These parts are available with your Enphase distributor.

4.6 IQ Cable planning and ordering

The IQ Cable is a continuous length of 12 AWG, double insulated, outdoor-rated cable with integrated connectors for microinverters. These connectors are preinstalled along the IQ Cable at intervals to accommodate varying PV module widths. The microinverters plug directly into the cable connectors.

The cabling is compatible with a variety of PV racking systems. For a list of approved PV racking systems, refer to the PV Racking Compatibility document on the Enphase website at enphase.com/support.

4.7 Connector spacing options

IQ Cable is available in three connector spacing options. The gap between connectors on the cable can be 1.3 meters, 2.0 meters, or 2.3 meters. The 1.3-meter spacing is best suited for connecting PV modules installed in portrait orientation, while the 2.0-meter and 2.3-meter spacing allows you to install 60-cell and 72-cell PV modules in landscape orientation, respectively.

4.8 Cabling options

Ordering options include:

Cable model	Connector spacing	PV module orientation	Connector count per box
Q-12-10-240	1.3 m (50")	Portrait	240
Q-12-17-240	2.0 m (78")	Landscape (60-cell)	240
Q-12-20-200	2.3 m (90")	Landscape (72-cell)	200

The cabling system is flexible enough to adapt to almost any solar design. To determine the cable type you need, apply the following considerations:

- When mixing PV modules in both portrait and landscape orientation, you may need to transition between cable types. See the preceding table for available cable types.
- To transition between cable types, install an IQ Field Wireable Connector pair.
- In situations where portrait modules are widely spaced, you may need to use landscape spaced cables for the portrait-oriented PV modules and create loops of excess cable, if needed.



WARNING: Do not form loops smaller than 12 cm (4.75") in diameter.

4.9 IQ Cable accessories

The IQ Cable is available with several accessory options for ease of installation, including:

- **IQ Field Wireable Connectors (male):** (Q-CONN-10M) Make connections from any Field Wireable female connector
- **IQ Field Wireable Connectors (female):** (Q-CONN-10F) Make connections from any IQ Cable open connector or Field Wireable male connector
- **IQ Aggregator:** (Q-BA-3-1P-60) Aggregates up to three fully populated 20 A branch circuits and supports solar arrays of up to 11.5 kWac with a single rooftop aggregator
- **IQ Raw Cable:** (Q-12-RAW-200) 300 meters of 12 AWG cable with no connectors
- **Cable clips:** (Q-CLIP-100) Used to fasten cabling to the racking or to secure looped cabling
- **IQ Disconnect Tool:** (Q-DISC-10) Disconnect tool for IQ Cable connectors, DC connectors, and AC module mount
- **IQ Sealing Caps (female):** (Q-SEAL-10) One needed to cover each unused connector on the cabling
- **IQ Terminator:** (Q-TERM-10) Terminator cap for cut cable ends

5 Technical data

5.1 Technical considerations

5.1.1 Module requirements

Apply the following considerations when installing the Enphase IQ7 Series Microinverter system:



WARNING: Risk of equipment damage. You must match the DC operating voltage range of the PV module with the allowable input voltage range of the Enphase microinverter.



WARNING: Risk of equipment damage. The maximum open circuit voltage of the PV module must not exceed the specified maximum input voltage of the Enphase microinverter.

- PV modules must have conductors labeled "PV Wire" or "PV Cable" to comply with NEC for ungrounded PV power systems.
- Verify that the voltage and current specifications of the PV module match those of the microinverter.
- The maximum short circuit current rating of the PV module must be equal to or less than the maximum input DC short circuit current rating of the microinverter.

The output voltage and current of the PV module depend on the quantity, size, and temperature of the PV cells, as well as the insolation of each cell. The highest PV module output voltage occurs when the temperature of the cells is the lowest, and the PV module is at an open circuit (not operating).

5.1.2 Bifacial modules

Enphase microinverters are compatible with bifacial PV modules. Bifacial solar modules produce power from both sides of a bifacial module, increasing total energy generation. The power gained from the rear side (bifacial gain) is highly influenced by various design factors such as albedo, module elevation, pitch, temperature, and shading. The bifacial gain can be anywhere between 0% to 30% of the nominal rating (front-side power rating) of the module. Since the bifacial gain is highly influenced by various design considerations, pairing the bifacial module with the right microinverter depends on the electrical characteristics of a given module.

The temperature-adjusted electrical parameters (maximum power, voltage, and current) of the bifacial modules, considering the front-side electrical parameters (i.e., 0% back-side gain), must be within the microinverter input parameters range.

See [Step 3: Mount the Microinverters](#) for tips on vertical mounting of bifacial modules.

5.2 Specifications

See the specifications in the following tables for:

- Enphase IQ7-60-2-US Microinverters
- Enphase IQ7PLUS-72-2-US Microinverters
- Enphase IQ7X-96-2-US Microinverters
- Enphase IQ7A-72-2-US Microinverters
- IQ Cable

5.2.1 IQ7-60-2-US Microinverter specifications

Enphase IQ7-60-2-US Microinverter parameters				
Topic	Unit	Min	Typical	Max
DC Parameters				
Commonly used module pairings ¹		235 W – 350+ W		
Peak power tracking voltage	V	27		37
Operating voltage range	V	16		48
Maximum input DC voltage	V			48
Minimum/Maximum start voltage	V	22		48
Maximum DC input short circuit current (module I _{sc})	A			15
Overvoltage class DC port			II	
DC Port backfeed under single fault	A			0
PV array configuration	1x1 ungrounded array; no additional DC side protection required; AC side protection requires max 20 A per branch circuit			
AC Parameters				
Maximum continuous AC output power (-40°F to +149°F)	VA	240		
Peak output power	VA	250		
Power factor (adjustable)		0.85 leading ...0.85 lagging		
Nominal AC output voltage range ²				
240 VAC (single phase)	V _{rms}	211		264
208 VAC (single phase)	V _{rms}	183		229
Nominal output current				
240 VAC (single phase)	A _{rms}		1.0	
208 VAC (single phase)	A _{rms}		1.15	
Nominal frequency	Hz		60	

¹ No enforced DC/AC ratio. See the compatibility calculator at enphase.com/en-us/support/module-compatibility

² Nominal Voltage Range can be extended if required by the utility.

Enphase IQ7-60-2-US Microinverter parameters				
Topic	Unit	Min	Typical	Max
Extended frequency range	Hz	47		68
Maximum AC output over current protection device	A	20		
AC short circuit fault current over three cycles	Arms for over three cycles	5.8		
High AC voltage trip limit accuracy	mVrms			280
Low AC voltage trip limit accuracy	mVrms	179		
Frequency trip limit accuracy	%	±0.1		
Trip time accuracy	milliseconds	±0.1% or two cycles		
Overvoltage class AC port			III	
AC port backfeed under single fault	A		0	
Power factor setting			1.0	
Miscellaneous parameters				
Maximum ³ microinverters per 20 A (max) AC branch circuit				16
240 VAC (single phase)				13
208 VAC (single phase)				
CEC weighted efficiency	%	97.0		
240 VAC (single phase)		96.5		
208 VAC (single phase)				
Static MPPT efficiency (weighted, ref EN 50530)	%	99.0		
Total harmonic distortion	%			5
Ambient temperature range	°F	-40		149
Night tare loss	mW			50
Storage temperature range	°F	-40		185
Features and Specifications				
Compatibility	Pairs with most 60-cell/120-half-cell PV modules.			
Dimensions not including mounting bracket	212 mm x 175 mm x 30.2 mm (approximate)			
Connector type	MC-4 connector			
Weight	1.08 kg (2.38 lbs.)			
Environmental category/UV exposure rating	NEMA type 6/outdoor			
Torque specifications for fasteners (Do not over torque)	<ul style="list-style-type: none"> • 6 mm (1/4") mounting hardware: 5 N m (45 to 50 in-lbs.) • 8 mm (5/16") mounting hardware: 9 N m (80 to 85 in-lbs.) • When using UL 2703 mounting hardware, use the manufacturer's recommended torque value 			

³ Limits may vary. Refer to local requirements to define the number of microinverters per branch in your area.

Enphase IQ7-60-2-US Microinverter parameters				
Topic	Unit	Min	Typical	Max
Cooling	Natural convection - no fans			
Relative humidity range	4% to 100% condensing			
Approved for wet locations	Yes			
Pollution degree	PD3			
Standard warranty term	enphase.com/warranty			
Compliance	CA Rule 21 (UL 1741-SA) UL 62109-1, UL1741/IEEE1547, FCC Part 15 Class B, ICES-0003 Class B, CAN/CSA-C22.2 NO. 107.1-01 This product is UL Listed as PV Rapid Shut Down Equipment and conforms with NEC-2014 and NEC-2017 section 690.12 and C22.1-2015 Rule 64-218 Rapid Shutdown of PV Systems for AC and DC conductors when installed according to manufacturer's instructions.			
Grounding	The DC circuit meets the requirements for ungrounded PV arrays in NEC. Ground fault protection (GFP) is integrated into the class II double-insulated microinverter.			
Monitoring	Enphase Installer Portal monitoring options require an Enphase IQ Gateway.			
Communication	Power line communication (PLC)			
Integrated DC disconnect/ Integrated AC disconnect	The DC and AC connectors have been evaluated and approved for use as the load-break disconnect required by NEC 690.			

5.2.2 IQ7PLUS-72-2-US Microinverter specifications

IQ7PLUS-72-2-US Microinverter parameters				
Topic	Unit	Min	Typical	Max
DC parameters				
Commonly used module pairings ⁴	W	235 W – 440+ W		
Peak power tracking voltage	V	27	36	45
Operating range	V	16		60
Maximum DC input voltage	V			60
Minimum/Maximum start voltage	V	22		60
Maximum DC input short circuit current (module I _{sc})	A			15
Overvoltage class DC port			II	
DC Port backfeed under single fault	A			0
PV array configuration	1x1 ungrounded array; no additional DC side protection required; AC side protection requires max 20 A per branch circuit			
AC parameters				
Maximum continuous AC output power (-40 to 149°F)	VA	290		
Peak output power	VA	295		
Power factor (adjustable)		0.85 leading ...0.85 lagging		
Nominal AC output voltage range ⁵				
240 VAC (single phase)	V _{rms}	211		264
208 VAC (single phase)	V _{rms}	183		229
Nominal output current				
240 VAC (single phase)	A _{rms}		1.21	
208 VAC (single phase)	A _{rms}		1.39	
Nominal frequency	Hz		60	
Extended frequency range	Hz	47		68
Maximum AC output over current protection device	A	20		
AC short circuit fault current over three cycles	A _{rms} for over three cycles	5.8		
High AC voltage trip limit accuracy	%	±1.0		
Low AC voltage trip limit accuracy	%	±1.0		
Frequency trip limit accuracy	%	±0.1		
Trip time accuracy	milliseconds	±0.1% or two cycles		
Overvoltage class AC port			III	
AC port backfeed under single fault	A		0	

⁴ No enforced DC/AC ratio. See the compatibility calculator at enphase.com/en-us/support/module-compatibility

⁵ Nominal Voltage Range can be extended if required by the utility.

IQ7PLUS-72-2-US Microinverter parameters				
Topic	Unit	Min	Typical	Max
Power factor setting			1.0	
Miscellaneous Parameters				
Maximum ⁶ microinverters per 20A (max) AC branch circuit				13
240 VAC (single phase)				11
208 VAC (single phase)				
CEC weighted efficiency	%			
240 VAC (single phase)		97.0		
208 VAC (single phase)		96.5		
Static MPPT efficiency (weighted, ref EN 50530)	%	99.0		
Total harmonic distortion	%			5
Ambient temperature range	°F	-40		+149
Night tare loss	mW			50
Storage temperature range	°F	-40		+185
Features and Specifications				
Compatibility	Pairs with most 60-cell/120-half-cell and 72-cell/144-half-cell PV modules			
Dimensions not including mounting bracket	212 mm x 175 mm x 30.2 mm (approximate)			
Connector type	MC-4 connector			
Weight	1.08 kg (2.38 lbs.)			
Environmental category/UV exposure rating	NEMA type 6/outdoor			
Torque specifications for fasteners (Do not over torque)	<ul style="list-style-type: none"> • 6 mm (1/4") mounting hardware: 5 N m (45 - 50 in-lbs.) • 8 mm (5/16") mounting hardware: 9 N m (80 - 85 in-lbs.) • When using UL 2703 mounting hardware, use the manufacturer's recommended torque value 			
Cooling	Natural convection - no fans			
Relative humidity range	4% to 100% condensing			
Approved for wet locations	Yes			
Pollution degree	PD3			
Communication	Power line communication (PLC)			
Standard warranty term	enphase.com/warranty			
Compliance	CA Rule 21 (UL 1741-SA) UL 62109-1, UL1741/IEEE1547, FCC Part 15 Class B, ICES-0003 Class B, CAN/CSA-C22.2 NO. 107.1-01. This product is UL Listed as PV Rapid Shut Down Equipment and conforms with NEC-2014 and NEC-2017 section 690.12 and C22.1-2015 Rule 64-218 Rapid Shutdown of PV Systems, for AC and DC conductors when installed according to manufacturer's instructions.			

⁶ Limits may vary. Refer to local requirements to define the number of microinverters per branch in your area.

IQ7PLUS-72-2-US Microinverter parameters				
Topic	Unit	Min	Typical	Max
Grounding	The DC circuit meets the requirements for ungrounded PV arrays in NEC. Ground fault protection (GFP) is integrated into the class II double-insulated microinverter.			
Monitoring	Enphase Installer Portal monitoring options require an Enphase IQ Gateway.			
Integrated DC disconnect/ Integrated AC disconnect	The DC and AC connectors have been evaluated and approved for use as the load-break disconnect required by NEC 690.			

5.2.3 IQ7X-96-2-US Microinverter specifications

IQ7X-96-2-US Microinverter parameters				
Topic	Unit	Min	Typical	Max
DC parameters				
Commonly used module pairings ⁷	W	320 W – 460+ W		
Peak power tracking voltage	V	53		64
Operating range	V	25		79.5
Maximum DC input voltage	V			79.5
Minimum/maximum start voltage	V	33		79.5
Maximum DC input short circuit current (module Isc)	A			10
Overvoltage class DC port			II	
DC Port backfeed under single fault	A			0
PV array configuration	1x1 ungrounded array; no additional DC side protection required; AC side protection requires max 20A per branch circuit			
AC parameters				
Maximum continuous AC output power (-40 to +149°F)	VA	315		
Peak output power	VA	320		
Power factor (adjustable)		0.85 leading ...0.85 lagging		
Nominal AC output voltage range ⁸				
240 VAC (single phase)	Vrms	211		264
208 VAC (single phase)	Vrms	183		229
Nominal output current				
240 VAC (single phase)	Arms		1.31	
208 VAC (single phase)	Arms		1.51	
Nominal frequency	Hz		60	

⁷ No enforced DC/AC ratio. See the compatibility calculator at enphase.com/en-us/support/module-compatibility

⁸ Nominal Voltage Range can be extended if required by the utility.

IQ7X-96-2-US Microinverter parameters				
Topic	Unit	Min	Typical	Max
Extended frequency range	Hz	47		68
Maximum AC output over current protection device	A	20		
AC short circuit fault current over three cycles	Arms for over three cycles	5.8		
High AC voltage trip limit accuracy	%	±1.0		
Low AC voltage trip limit accuracy	%	±1.0		
Frequency trip limit accuracy	%	±0.1		
Trip time accuracy	milliseconds	±0.1% or two cycles		
Overvoltage class AC port			III	
AC port backfeed under single fault	A		0	
Power factor setting			1.0	
Miscellaneous parameters				
Maximum ⁹ microinverters per 20 A (max) AC branch circuit				12
240 VAC (single phase)				10
208 VAC (single phase)				
CEC weighted efficiency	%			
240 VAC (single phase)		97.5		
208 VAC (single phase)		97.0		
Static MPPT efficiency (weighted, ref EN 50530)	%	99.0		
Total harmonic distortion	%			5
Ambient temperature range	°F	-40		140
Night tare loss	mW			50
Storage temperature range	°F	-40		185
Features and specifications				
Compatibility	Pairs with 96-cell PV modules			
Dimensions not including mounting bracket	212 mm x 175 mm x 30.2 mm (approximate)			
Connector type	MC-4 connector			
Weight	1.08 kg (2.38 lbs.)			
Environmental category/UV exposure rating	NEMA type 6/outdoor			
Torque specifications for fasteners (Do not over torque)	<ul style="list-style-type: none"> • 6 mm (1/4") mounting hardware: 5 N m (45 – 50 in-lbs.) • 8 mm (5/16") mounting hardware: 9 N m (80 – 85 in-lbs.) • When using UL 2703 mounting hardware, use the manufacturer's recommended torque value 			
Cooling	Natural convection - no fans			
Relative humidity range	4% to 100% condensing			

⁹ Limits may vary. Refer to local requirements to define the number of microinverters per branch in your area.

IQ7X-96-2-US Microinverter parameters				
Topic	Unit	Min	Typical	Max
Approved for wet locations	Yes			
Pollution degree	PD3			
Communication	Power line communication (PLC)			
Standard warranty term	enphase.com/warranty			
Compliance	CA Rule 21 (UL 1741-SA) UL 62109-1, UL1741/IEEE1547, FCC Part 15 Class B, ICES-0003 Class B, CAN/CSA-C22.2 NO. 107.1-01 This product is UL Listed as PV Rapid Shut Down Equipment and conforms with NEC-2014 and NEC-2017 section 690.12 and C22.1-2015 Rule 64-218 Rapid Shutdown of PV Systems for the AC and DC conductors when installed according to manufacturer's instructions.			
Grounding	The DC circuit meets the requirements for ungrounded PV arrays in NEC. Ground fault protection (GFP) is integrated into the class II double-insulated microinverter.			
Monitoring	Enphase Installer Portal monitoring options require an Enphase IQ Gateway.			
Integrated DC disconnect/ Integrated AC disconnect	The DC and AC connectors have been evaluated and approved for use as the load-break disconnect required by NEC 690.			

5.2.4 IQ7A-72-2-US Microinverter specifications

IQ7A-72-2-US Microinverter parameters				
Topic	Unit	Min	Typical	Max
DC parameters				
Commonly used module pairings ¹⁰	W	295 W – 460+ W		
Peak power tracking voltage	V	38		43
Operating range	V	18		58
Maximum DC input voltage	V			58
Minimum/Maximum start voltage	V	30		58
Maximum DC input short circuit current (module I _{sc})	A			15
Overvoltage class DC port			II	
DC Port backfeed under single fault	A			0
PV array configuration	1x1 ungrounded array; no additional DC side protection required; AC side protection requires max 20A per branch circuit			

¹⁰ No enforced DC/AC ratio. See the compatibility calculator at enphase.com/en-us/support/module-compatibility

IQ7A-72-2-US Microinverter parameters				
Topic	Unit	Min	Typical	Max
AC parameters				
Maximum continuous AC output power (-40 to 140°F)	VA	349 VA @ 240 VAC	290 VA @ 208 VAC	
Peak output power	VA	366 VA @ 240 VAC	295 VA @ 208 VAC	
Power factor (adjustable)		0.85 leading ...0.85 lagging		
Nominal AC output voltage range ¹¹				
240 VAC (single phase)	Vrms	211		264
208 VAC (single phase)	Vrms	183		229
Nominal output current				
240 VAC (single phase)	Arms		1.45	
208 VAC (single phase)	Arms		1.39	
Nominal frequency	Hz		60	
Extended frequency range	Hz	47		68
Maximum AC output over current protection device	A	20		
AC short circuit fault current over three cycles	Arms for over three cycles	5.8		
High AC voltage trip limit accuracy	%	±1.0		
Low AC voltage trip limit accuracy	%	±1.0		
Frequency trip limit accuracy	%	±0.1		
Trip time accuracy	milliseconds	±0.1% or two cycles		
Overvoltage class AC port			III	
AC port backfeed under single fault	A		0	
Power factor setting			1.0	
Miscellaneous parameters				
Maximum ¹² microinverters per 20A (max) AC branch circuit				
240 VAC (single phase)				11
208 VAC (single phase)				11
CEC weighted efficiency	%			
240 VAC (single phase)		97.0		
208 VAC (single phase)		96.5		
Static MPPT efficiency (weighted, ref EN 50530)	%	99.0		
Total harmonic distortion	%			5
Ambient temperature range	°F	-40		140
Night tare loss	mW			60
Storage temperature range	°F	-40		185

¹¹ Nominal Voltage Range can be extended if required by the utility.

¹² Limits may vary. Refer to local requirements to define the number of microinverters per branch in your area.

IQ7A-72-2-US Microinverter parameters				
Topic	Unit	Min	Typical	Max
Features and specifications				
Compatibility	Pairs with most 60-cell/120- half-cell and 72-cell/144-half-cell PV modules			
Dimensions not including mounting bracket	212 mm x 175 mm x 30.2 mm (approximate)			
Connector type	MC-4 connector			
Weight	1.08 kg (2.38 lbs.)			
Environmental category/UV exposure rating	NEMA type 6/outdoor			
Torque specifications for fasteners (Do not over torque)	<ul style="list-style-type: none"> • 6 mm (1/4") mounting hardware: 5 N m (45 – 50 in-lbs.) • 8 mm (5/16") mounting hardware: 9 N m (80 – 85 in-lbs.) • When using UL 2703 mounting hardware, use the manufacturer's recommended torque value 			
Cooling	Natural convection - no fans			
Relative humidity range	4% to 100% condensing			
Approved for wet locations	Yes			
Pollution degree	PD3			
Communication	Power line communication (PLC)			
Standard warranty term	enphase.com/warranty			
Compliance	CA Rule 21 (UL 1741-SA) UL 62109-1, UL1741/IEEE1547, FCC Part 15 Class B, ICES-0003 Class B, CAN/CSA-C22.2 NO. 107.1-01 This product is UL Listed as PV Rapid Shut Down Equipment and conforms with NEC-2014 and NEC-2017 section 690.12 and C22.1-2015 Rule 64-218 Rapid Shutdown of PV Systems for AC and DC conductors, when installed according to manufacturer's instructions.			
Grounding	The DC circuit meets the requirements for ungrounded PV arrays in NEC. Ground fault protection (GFP) is integrated into the class II double-insulated microinverter.			
Monitoring	Enphase Installer Portal monitoring options require an Enphase IQ Gateway.			
Integrated DC disconnect/ Integrated AC disconnect	The DC and AC connectors have been evaluated and approved for use as the load-break disconnect required by NEC 690.			

5.2.5 IQ Cable specifications

Specification	Value
Voltage rating	600 V
Voltage withstand test (kV/1min)	AC 3.0
Max DC conductor resistance (68°F) (Ω/km)	5.433
Insulation resistance (68°F)	≥20M (Ω/km)
System temperature range (ambient)	-40°F to 149°F
Cable temperature rating	194°F Dry / 194°F Wet
Cable rating	DG
Certification	UL 3003, TC-ER equivalent
Flame test rating	FT4
Cable conductor insulator rating	THHN/THWN-2
Environmental protection rating	IEC 60529 IP67 NEMA 6
UV resistance	720 h
Compliance	RoHS, OIL RES I, CE, UV Resistant, combined UL for Canada and the United States
Conductor size	12 AWG
Maximum loop size	12 cm (4.75 ")
Flat cable dimensions	6 mm x 9.5 mm (0.2" x 0.37")
Sealing cap dimensions	38.6 mm x 20 mm (1.5" x 0.7")
Cable connector dimensions	20 mm x 1.1 mm x 6.5 mm (0.7" x 0.04" x 0.25")

5.2.6 Enphase connector ratings

Enphase connectors on the cable assemblies in the following table have a maximum current of 20 A, a maximum OCPD of 20 A, and a maximum ambient temperature of -40°C to 79°C (-40°F to 174.2°F) and are rated for disconnection under load.

Part number	Model	Maximum voltage
840-00387	Q-12-10-240	277 VAC
840-00388	Q-12-17-240	277 VAC
840-00389	Q-12-20-200	277 VAC
840-00385	Q-DCC-2	100 VDC
840-00386	Q-DCC-5	100 VDC

5.3 Enphase installation map

To Sheet / A la hoja de: ↑

Panel Group/Grupo de los paneles: Azimuth/Azímüt: Tilt/Inclinación: Sheet/Hoja ____ of/de ____	Customer/Cliente:	Installer/Instalador:	7	6	5	4	3	2	1
A									
B									
C									
D									
E									
F									
G									
H									
J									
K									
L									
M									

To Sheet / A la hoja de: ↓

Scan completed map and upload it to Enphase. Click "Add a New System" at <https://enlighten.enphaseenergy.com>. Use this map to build the virtual array in Enlighten's Array Builder. /

Escanee el mapa completo y cárguelo en Enphase. Haga clic en "Añadir nuevo sistema" en <https://enlighten.enphaseenergy.com>. Utilice este mapa para crear el conjunto de paneles virtual en el Creador de conjuntos de paneles de Enlighten.

Envoy Serial Number Label /
Número de serie de Envoy

To Sheet / A la hoja de: ↓

Sample wiring diagram

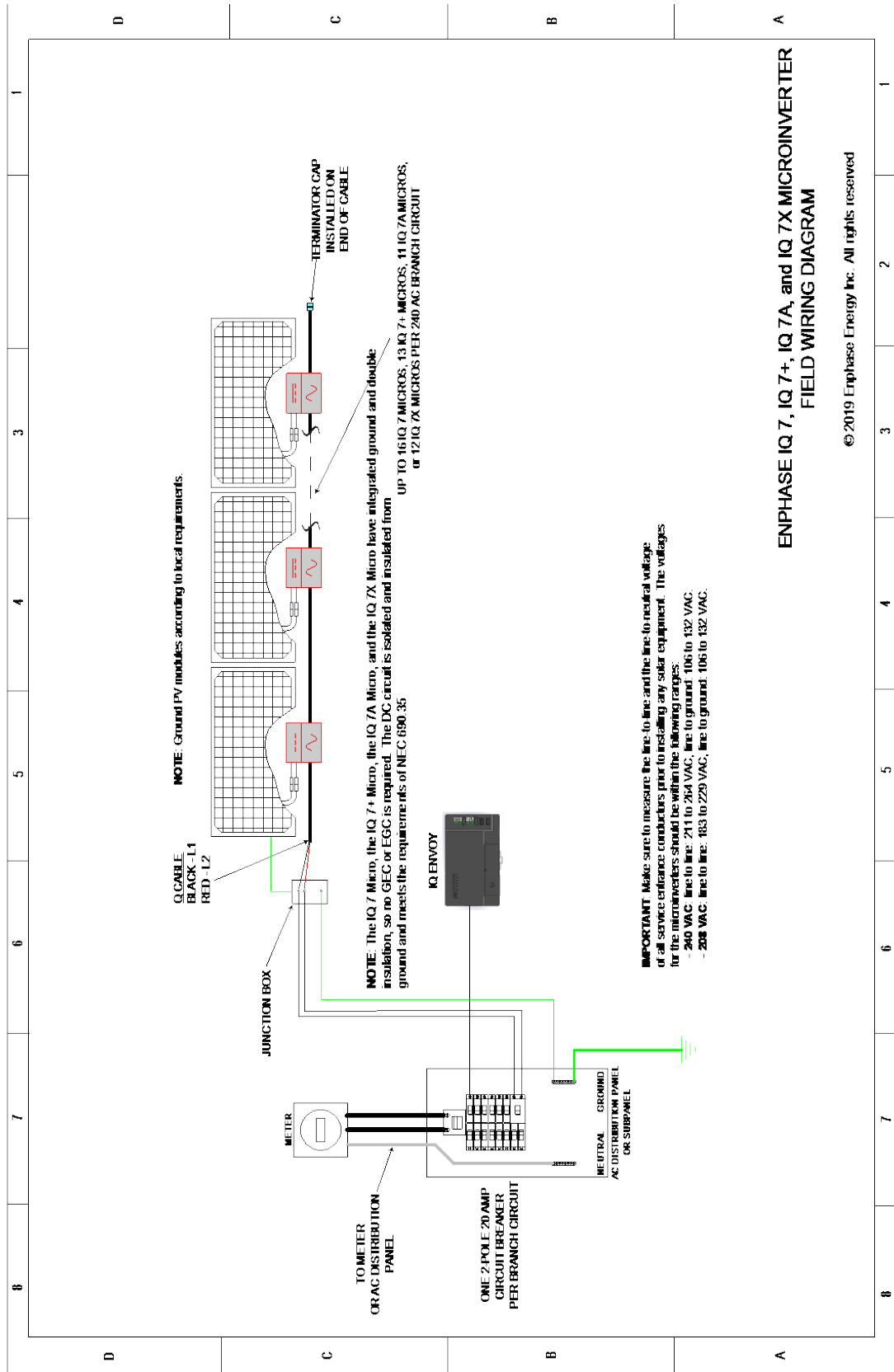

Revision history

Revision	Date	Description
IOM-00028-1.0	September 2023	Updated the document to the latest template.