

Wiring The Rapid Shutdown Switch to IQ System Controller 2

Overview

The Enphase rapid shutdown switch/Enphase system shutdown switch (EP200G-NA-02-RSD) provides Rapid Shutdown (RSD) capability, as required by NEC standard, for IQ8 Microinverters when used with IQ System Controller 2 (EP200G101-M240US01). The Rapid Shutdown Switch and IQ System Controller 2 are certified to the UL1741 Photovoltaic Rapid Shutdown Equipment (PVRSE) requirement.

This special bulletin includes instructions to enable installers to avoid issues with the rapid shutdown switch wiring and installation. The bulletin covers:

1. When to use the RSD switch with IQ System Controller 2 (EP200G101-M240US01)?

The RSD switch is required and must only be used for IQ8 microinverters. Refer to page 2 of this bulletin on how to use IQ System Controller 2 with legacy microinverters (IQ6/7 or M215/250)

2. How to safely wire the RSD switch to the IQ System Controller 2?

Installers **MUST** ensure that the IQ System Controller 2 is powered off before performing any wiring. Wiring an energized IQ System Controller 2 is a safety hazard. If the RSD terminals are inadvertently connected to any other conductive surface while the IQ System Controller 2 is energized the IQ System Controller 2 can be damaged and will require replacement.

Installers must follow the wiring scheme as described in this document. The wiring scheme for the Rapid Shutdown Switch depicted in the installation guide is incorrect for a small number of IQ System Controller 2 units manufactured prior to December 8, 2021. Incorrect wiring prevents IQ System Controller 2 from exiting the rapid shutdown state and from being commissioned correctly. The installation guides with incorrect wiring scheme have a revision of 140-00236-02 or lower.

It is recommended that installers remove the terminal block from System Controller before wiring the jumpers/ cable headers.

3. How to energize IQ System Controller 2 and exit Rapid Shutdown?

Installer must keep the Rapid Shutdown (RSD) switch turned off before energizing the IQ System Controller 2. If the RSD switch is turned on before energizing the IQ System Controller 2, the IQ System Controller 2 goes into manual override mode, which forces installers to follow the process to remove the IQ System Controller from manual override mode and leads to delays during commissioning.

4. How to verify the Rapid Shutdown (RSD) switch installation and functionality?

Page 5 of this document provides the procedure to verify RSD switch installation and functionality.

5. When to use the RSD switch with IQ System Controller 2?

The RSD switch is required and must only be used for IQ8 microinverters. For systems with grid tied PV i.e., IQ6/7 or M215/250 microinverters, installers must not use the Rapid shutdown switch. Rapid Shutdown operation for these microinverters can be initiated in one of three ways

- a. The AC circuit breaker installed within the IQ Combiner
- b. Or the AC circuit breaker installed within IQ System Controller
- c. Or a dedicated AC disconnect switch in series with the combined PV inverter circuit

Installer must follow all national and local codes while installing PV systems and Rapid Shutdown initiators.

It is recommended that installers remove the terminal block from System Controller before wiring the jumpers/ cable headers.

For systems with grid tied PV i.e., IQ6/7 or M215/250 microinverters, installers must wire a jumper across the NC3 and NC4 terminals. If using 28AWG to 16AWG wire, installers can simply jumper the RSD terminals as shown in the figure below:

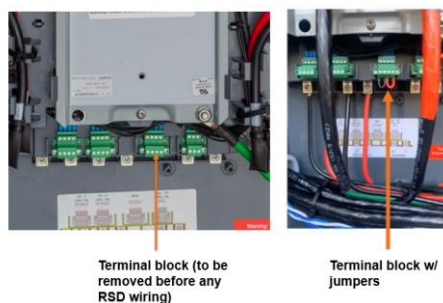

The RSD and other auxiliary contact terminals in the IQ System Controller 2 are rated for up to 16AWG wire. To avoid damaging the RSD terminals, installers **MUST** use the cable header assembly to connect wires thicker than 16AWG to the terminals, as shown in the figure below:

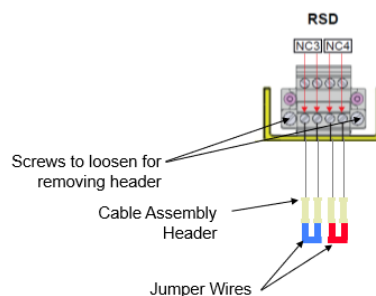

The cable header assembly will look like below and it can be found in the System Controller LITKIT (or accessory bag).

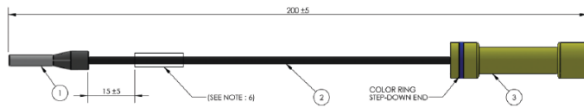

6. How to safely wire the RSD switch to the IQ System Controller 2?

The Rapid shutdown terminals in IQ System Controller 2 (NC3 and NC4) carry a high voltage. Installers **MUST** ensure that the IQ System Controller 2 is powered off before performing any wiring. If IQ System Controller 2 is already energized, it should be completely discharged before wiring the rapid shutdown switch. The instructions for discharging the IQ System Controller 2 can be found in Annexure 1. For grid forming systems with IQ8 microinverters follow below instructions when wiring the IQ System Controller 2 RSD terminal to the Enphase System Shutdown Switch (EP200G-NA-02-RSD).

Before wiring, it is recommended that the terminal block for RSD wires in System Controller be removed from the System Controller and plugged back in after the wiring is completed.

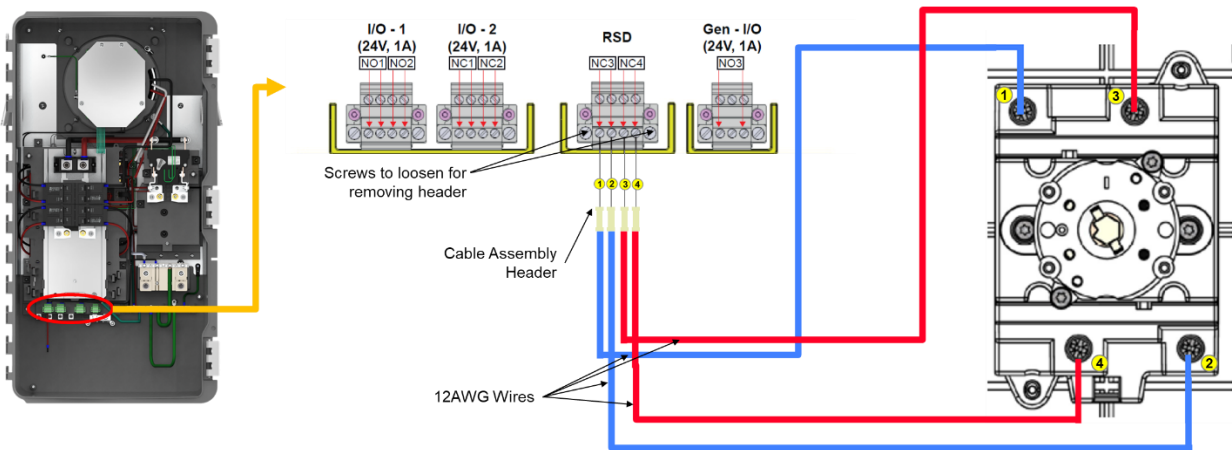

RSD terminal		Switch terminals
NC3	Terminal 1(+Ve)	Terminal 1
	Terminal 2 (-ve)	Terminal 2
NC4	Terminal 3(+Ve)	Terminal 3
	Terminal 4 (-ve)	Terminal 4

The actual Enphase System Shutdown switch is shown below with terminal numbers as outlined above.

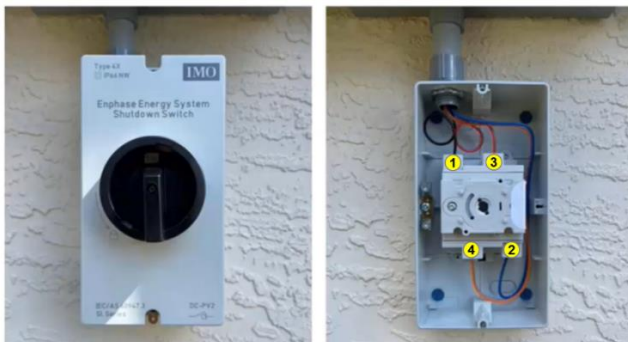

7. How to energize IQ System Controller 2 and exit Rapid Shutdown?

The Rapid Shutdown (RSD) switch must be wired BEFORE ENERGIZING the IQ System Controller 2. Upon completing the wiring of the switch using the correct wiring instructions, the RSD switch must be kept in OFF position as shown below, before the IQ System Controller 2 is Energized.

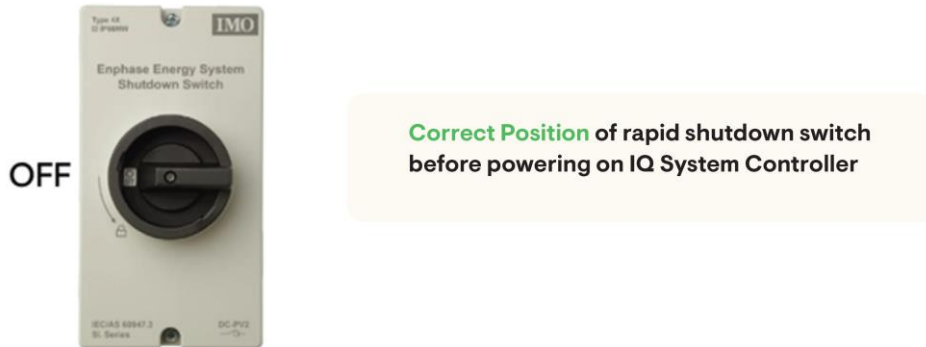

The correct way to energize the IQ System Controller 2 and the system is available in [Annexure 2: Instructions to Energize IQ System Controller 2](#) in this document.

8. How to verify the Rapid Shutdown (RSD) switch installation and functionality?

After installing the Rapid Shutdown switch and energizing the IQ System Controller 2 follow the below procedure to verify the functionality of the Rapid Shutdown switch.

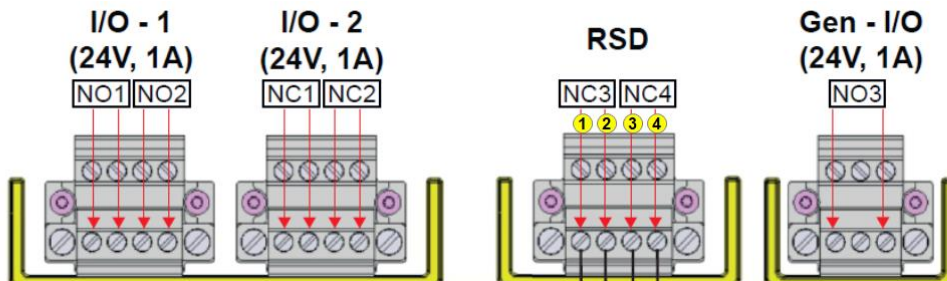

1. Ensure the Rapid Shutdown Switch is turned ON.
 - a) Check the voltage across the two screws of the NC3 terminal (as shown above).
 - If the voltage across the pins is ~3.3 Vdc then the switch is NOT wired correctly. Fix the wiring per instructions [here](#).
 - If the voltage across the pins is ~0 Vdc then the switch is wired correctly.
 - b) Check the voltage across the two screws of the NC4 terminal (refer to Figure 3).
 - If the voltage across the pins is ~3.3 Vdc then the switch is NOT wired correctly. Fix the wiring per instructions [here](#).
 - If the voltage across the pins is ~0 Vdc then the switch is wired correctly.
2. Ensure the Rapid Shutdown Switch is turned OFF.
 - a) Check the voltage across the two screws of the NC3 terminal (refer to Figure 3).
 - If the voltage across the pins is ~0 Vdc then the switch is NOT wired correctly. Fix the wiring per instructions [here](#).
 - If the voltage across the pins is ~3.3 Vdc then the switch is wired correctly.
 - b) Check the voltage across the two screws of the NC4 terminal (refer to Figure 3).

- If the voltage across the pins is ~0 Vdc then the switch is NOT wired correctly. Fix the wiring per instructions [here](#).
 - If the voltage across the pins is ~3.3 Vdc then the switch is wired correctly.
3. Ensure you turn the Rapid Shutdown Switch back ON.

Annexure 1: Instructions to discharge the IQ System Controller 2

- a) Turn DC switches in IQ Batteries to off (if Battery is installed)
- b) Open IQ Battery breaker in IQ System Controller.
- c) Open PV breaker in IQ System Controller.
- d) Open the mains breaker.
- e) Disconnect the grid source power supply (breaker in main panel).
- f) Open generator breaker.
- g) Use multi meter to measure AC voltage on all the following terminals – PV, IQ Battery, Grid, Load and Generator. It is safe to work on IQ System Controller only when no voltage is detected on any of these terminals, and you have ensured that all IQ Battery units have DC switches powered off.
- h) Wait for 5 mins before proceeding with wiring the RSD switch, follow the wiring diagram shared herein or in Rapid Shutdown switch installation guide.

Annexure 2: Instructions to energize the IQ System Controller 2

After wiring the RSD switch, please follow the following instructions to power on the IQ System Controller 2.

- a) You must ensure that all electrical circuits external to IQ System Controller are completed and safe before energizing IQ System Controller in the following order:
 - Turn On NFT breaker
 - Turn On Main breaker
 - Turn On PV breaker
 - Turn On IQ Battery breaker
 - Turn On Generator breaker
 - Turn On Load breaker
- b) Wait and observe if the IQ Battery red LEDs flash 3 times continuously. Wait for up to 10 minutes, with the red LED flashing, before turning on the DC switch on IQ Battery. The IQ Battery LED should change to blue or green based on SOC of battery.
- c) Close the cover of the IQ Battery.
- d) Energize the circuit feeding the IQ System Controller. If installed, turn the breaker feeding the IQ System Controller to ON position.
- e) Close and secure the door of the IQ System Controller.
- f) Turn the RSD switch to the ON position.