







## ALL-BLACK CS6K-290 | 295 | 300MS

Canadian Solar's All-Black CS6K-MS modules enhance the aesthetics of our 5 bus bar mono modules while providing a higher energy output. All-Black CS6K-MS modules are equipped with Mono-PERC cells, a dark colored backsheet and a black frame.

### KEY FEATURES

-  9 % more power than conventional modules
-  Excellent performance at low irradiance of up to: 97.5 %
-  Improved energy production due to low temperature coefficients
-  IP68 junction box for long-term weather endurance
-  Heavy snow load up to 6000 Pa, wind load up to 4000 Pa \*

**25**  
years  
linear power output warranty

**10**  
years  
product warranty on materials and workmanship

### MANAGEMENT SYSTEM CERTIFICATES\*

ISO 9001:2008 / Quality management system  
ISO 14001:2004 / Standards for environmental management system  
OHSAS 18001:2007 / International standards for occupational health & safety

### PRODUCT CERTIFICATES\*

IEC 61215 / IEC 61730: VDE / CE / MCS / CEC AU  
UL 1703 / IEC 61215 performance: CEC listed (US)  
UL 1703: CSA  
Take-e-way



\* Please contact your local Canadian Solar sales representative for the specific product certificates applicable in your market.

**CANADIAN SOLAR INC.** is committed to providing high quality solar products, solar system solutions and services to customers around the world. As a leading PV project developer and manufacturer of solar modules with over 20 GW deployed around the world since 2001, Canadian Solar Inc. (NASDAQ: CSIQ) is one of the most bankable solar companies worldwide.

\*For detail information, please refer to Installation Manual.

### CANADIAN SOLAR INC.

545 Speedvale Avenue West, Guelph, Ontario N1K 1E6, Canada, [www.canadiansolar.com](http://www.canadiansolar.com), [support@canadiansolar.com](mailto:support@canadiansolar.com)

## ENGINEERING DRAWING (mm)

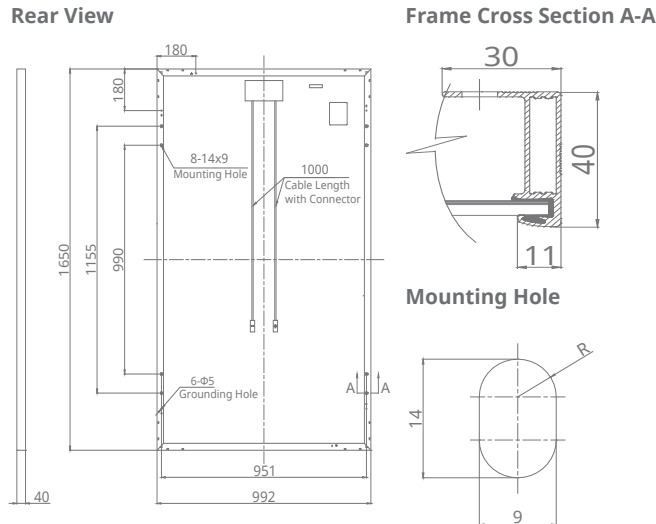

## ALL-BLACK CS6K-295MS / I-V CURVES

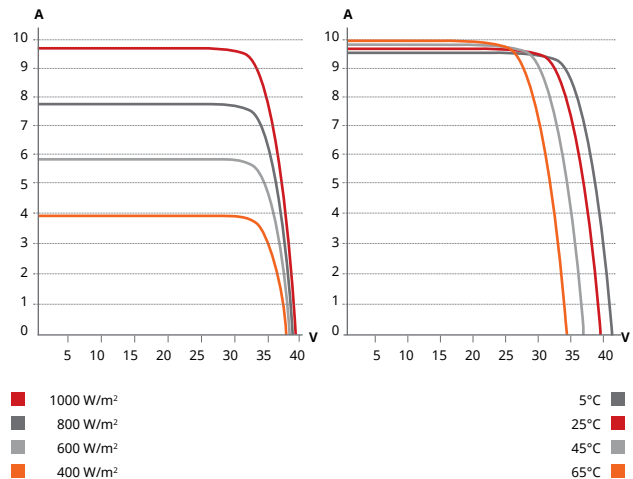

## ELECTRICAL DATA | STC\*

All-Black CS6K	290MS	295MS	300MS
Nominal Max. Power (Pmax)	290 W	295 W	300 W
Opt. Operating Voltage (Vmp)	32.1 V	32.3 V	32.5 V
Opt. Operating Current (Imp)	9.05 A	9.14 A	9.24 A
Open Circuit Voltage (Voc)	39.3 V	39.5 V	39.7 V
Short Circuit Current (Isc)	9.67 A	9.75 A	9.83 A
Module Efficiency	17.72 %	18.02 %	18.33 %
Operating Temperature	-40°C ~ +85°C		
Max. System Voltage	1000 V (IEC) or 1000 V (UL)		
Module Fire Performance	TYPE 1 (UL 1703) or CLASS C (IEC 61730)		
Max. Series Fuse Rating	15 A		
Application Classification	Class A		
Power Tolerance	0 ~ + 5 W		

\* Under Standard Test Conditions (STC) of irradiance of 1000 W/m<sup>2</sup>, spectrum AM 1.5 and cell temperature of 25°C.

## ELECTRICAL DATA | NMOT\*

All-Black CS6K	290MS	295MS	300MS
Nominal Max. Power (Pmax)	214 W	218 W	221 W
Opt. Operating Voltage (Vmp)	29.5 V	29.7 V	29.9 V
Opt. Operating Current (Imp)	7.24 A	7.32 A	7.40 A
Open Circuit Voltage (Voc)	36.7 V	36.9 V	37.1 V
Short Circuit Current (Isc)	7.81 A	7.87 A	7.94 A

\* Under Nominal Module Operating Temperature (NMOT), irradiance of 800 W/m<sup>2</sup>, spectrum AM 1.5, ambient temperature 20°C, wind speed 1 m/s.

## PERFORMANCE AT LOW IRRADIANCE

Outstanding performance at low irradiance, with an average relative efficiency of 97.5 % from irradiances, between 200 W/m<sup>2</sup> and 1000 W/m<sup>2</sup> (AM 1.5, 25°C).

The aforesaid datasheet only provides the general information on Canadian Solar products and, due to the on-going innovation and improvement, please always contact your local Canadian Solar sales representative for the updated information on specifications, key features and certification requirements of Canadian Solar products in your region.

Please be kindly advised that PV modules should be handled and installed by qualified people who have professional skills and please carefully read the safety and installation instructions before using our PV modules.

## MECHANICAL DATA

Specification	Data
Cell Type	Mono-crystalline, 6 inch
Cell Arrangement	60 (6×10)
Dimensions	1650×992×40 mm (65.0×39.1×1.57 in)
Weight	18.2 kg (40.1 lbs)
Front Cover	3.2 mm tempered glass
Frame Material	Anodized aluminium alloy
J-Box	IP68, 3 diodes
Cable	4.0 mm <sup>2</sup> (IEC), 12 AWG (UL), 1000 mm (39.4 in)
Connectors	T4 series
Per Pallet	27 pieces, 538 kg (1186.1 lbs)
Per Container (40' HQ)	756 pieces

## TEMPERATURE CHARACTERISTICS

Specification	Data
Temperature Coefficient (Pmax)	-0.39 % / °C
Temperature Coefficient (Voc)	-0.29 % / °C
Temperature Coefficient (Isc)	0.05 % / °C
Nominal Module Operating Temperature (NMOT)	43±2 °C

## PARTNER SECTION

